

VIBIA

light is creation

VIBIA
LIGHT IS CREATION

Light is creation

Light creates, renders and gives life.
Through light we perceive the landscape, architecture and the spaces we inhabit,
stimulating our senses and perceptions.

Each of us possesses a unique identity, a personal point of view
and a subjective way of perceiving reality.

VIBIA aims to create solutions that adapt to the needs of people within diverse contexts.
Our mission is to improve the relationships between people and their surroundings,
their visual and emotional well being.

When designing spaces lighting becomes an integral element within the process
in terms of the architecture, interior design and use.
Through our lighting we want to help create the right atmosphere so that the experience
of living every space is a fulfilled and unique one.

Collaboration

We look after the professionals who "create spaces", imagining with them and sharing their concerns.
We like to be in close contact with the day-to-day reality of designers in order to come
up with the right solutions which are sometimes unexpected.

We become the close allies of lighting designers, architects, interior designers and artists
through the creative process of lighting design, a shared mission for improved living.
We hope that our proposed products stimulate inspiration, helping to surprise,
going far beyond to explore new horizons ...

The Vibia experience

We offer a unique collection of products and solutions that stimulate
lighting professionals and help generate spaces.

The experience is developed through vibia.com, a virtual space where users can be fully
connected to create and share inspiration, get information easily and efficiently
working with a permanent back-up team.

Our online tools bring products and spaces together,
making design easier and creating a system that treats light and lighting as a tangible
quantity in space, that can be moulded to project-based needs and desires.

And of course people always first, with the guarantee of a close personal relationship with our
local team offering back-up over the entire work process.
We endeavour to provide an honest, friendly and efficient service.

Vibia, our own ecosystem

We are evolving our own bespoke model where we try to foster and bring talent together,
within an organization where creativity and innovation are an attitude that questions the established,
constantly searching for new and better concepts.

Within the VIBIA ecosystem we like to listen, to understand and to help, share doubts and imagine
spaces and lived environments, providing the best unique solutions.

We live for the exciting challenge of developing top-class products
and supporting and engaging with a global community.

Light is creation

La luz crea, modela y da vida.

A través de la luz percibimos el paisaje, la arquitectura y los espacios que habitamos, estimulando nuestros sentidos y percepciones.

Cada uno de nosotros dispone de una identidad propia, una mirada única y una manera subjetiva de percibir la realidad.

VIBIA tiene la vocación de crear soluciones que se adapten a las necesidades de las personas en diversos contextos.

Nuestra misión es mejorar la interacción de las personas con su entorno y su bienestar visual y emocional.

Durante el proceso de diseño de un espacio, la iluminación se convierte en elemento transversal a su arquitectura, interiorismo y uso.

Con nuestras luminarias queremos contribuir a generar la atmósfera adecuada para que la experiencia de vivir cada espacio sea plena y única.

Colaboración

Acompañamos a los profesionales "creadores de espacios", imaginando con ellos y compartiendo sensibilidades. Nos gusta estar atentos a las realidades de las personas para proponer soluciones adecuadas y muchas veces no esperadas.

Somos cómplices del proceso creativo de diseñadores de iluminación, arquitectos, interioristas y artistas, en la misión compartida de crear espacios donde se viva mejor. Deseamos que nuestra propuesta de productos estimule su inspiración, contribuyendo a sorprender, a ir más allá, a explorar en nuevos límites.

The Vibia experience

Ofrecemos una propuesta única de productos y soluciones, estimulante para los profesionales de la iluminación y de la creación de espacios.

La experiencia se prolonga en vibia.com, espacio que permite estar permanentemente conectados para generar y compartir inspiración, obtener información de manera fácil y eficiente y estar en comunicación permanente.

Nuestras herramientas online integran productos y espacios, facilitan el trabajo y forman un sistema capaz de ayudarnos a utilizar la luz y las luminarias como una magnitud modelable en el espacio, que se ajuste a las necesidades y deseos del proyecto.

Y por supuesto, las personas lo primero, siempre con el compromiso de una relación personal cercana a través de nuestros equipos locales y ofreciendo el acompañamiento que se requiera durante todo el proceso. Procuramos una manera de trabajar genuina, amable y eficiente.

Vibia, un ecosistema propio

Vamos configurando un modelo propio, donde procuramos que conviva y se expanda el talento, en una organización donde la creatividad y la innovación son una actitud que cuestiona lo establecido y busca permanentemente aportar nuevos conceptos y mejoras.

En el ecosistema Vibia, nos gusta escuchar, entender y atender, compartir inquietudes e imaginar espacios y entornos habitados, proporcionando soluciones óptimas y únicas.

Light is creation

Das Licht kreiert, modelliert und verschafft Leben.

Durch das Licht nehmen wir die Landschaft, die Architektur und die Lebensräume wahr, wodurch unsere Empfindungen und Wahrnehmungen stimuliert werden.

Jeder einzelne von uns verfügt über eine eigene Identität, einen einzigartigen Blick und eine subjektive Art und Weise, die Realität wahrzunehmen.

VIBIA hat die Berufung, Lösungen zu schaffen, die sich den Notwendigkeiten der Menschen unter verschiedenartigen Umständen anpassen. Unsere Mission besteht darin, die Wechselbeziehung der Menschen zu ihrer Umgebung und ihr visuelles und emotionelles Wohlbefinden zu verbessern.

Während des Prozesses des Entwurfs eines Raumes verwandelt sich die Beleuchtung in das transversale Element seiner Architektur, seiner Innendekoration und seiner Nutzung. Mit unseren Leuchtkörpern wollen wir dazu beitragen, die angemessene Atmosphäre zu erzeugen, damit die Erfahrung jeden Raum zu erleben voll und einzigartig ausfällt.

Zusammenarbeit

Wir begleiten die „raumschaffenden“ Fachleute, indem wir uns zusammen mit ihnen Dinge vorstellen und Sensibilitäten teilen. Wir möchten den Personen gegenüber aufmerksam sein, um angebrachte aber oftmals nicht erwartete Lösungen vorzuschlagen.

Wir sind Komplizen des kreativen Prozesses von Leuchtendesignern, Architekten, Innendekorateuren und Künstlern, mit der mit ihnen geteilten Mission, Räume zu schaffen, in denen man besser lebt. Wir wünschen, dass unser Produktvorschlag ihre Inspiration stimuliert und dazu beiträgt, zu überraschen, weiter fortzuschreiten und neue Grenzen zu erforschen.

The Vibia experience

Wir bieten ein einzigartiges Angebot von Produkten und Lösungen an, das Fachleute der Beleuchtung und der Kreation von Räumen stimuliert. Die Erfahrung wird erweitert durch "vibia.com", eine Web-Site, die uns erlaubt, ununterbrochen angeschlossen zu sein, um Inspirationen zu schaffen und sie zu teilen, wobei auf einfache und wirksame Weise Informationen eingeholt werden und permanent eine Kommunikation aufrecht erhalten wird.

Unsere Online-Werkzeuge integrieren Produkte und Räume, erleichtern die Arbeit und bilden ein System, mit dem wir das Licht und die Beleuchtung wie ein im Raum zu modellierendes Element einsetzen können, das sich den Notwendigkeiten und Wünschen des Projektes anpasst.

Und selbstverständlich, an erster Stelle die Personen, immer mit dem Engagement einer persönlichen nahen Beziehung mit Hilfe unserer lokalen Teams und mit dem Angebot der Zusammenarbeit, die während des gesamten Prozesses erwünscht ist. Wir versuchen eine authentische, lebenswürdige und effiziente Arbeitsweise zu beschaffen.

Vibia, ein eigenes Ökosystem

Wir gestalten ein eigenes Modell, bei dem wir versuchen, dass das Talent mit uns zusammenlebt und sich in einer Organisation ausbreitet, in der die Kreativität und die Innovation eine Einstellung wiedergibt, die das Festgelegte in Frage stellt und permanent danach sucht, neue Konzepte und Verbesserungen zu erbringen.

Beim Ökosystem Vibia, haben wir Gefallen daran, zuzuhören, zu verstehen und Beachtung zu zeigen, Interessen zu teilen und uns Räume sowie bewohnte Umgebungen vorzustellen, die optimale und einzigartige Lösungen bereit stellen.

Wir leben für die hinreißende Herausforderung, Produkte erster Klasse zu entwickeln und eine globale Gemeinschaft zu unterstützen und zu engagieren.

Light is creation

La luce crea, modella e dà vita.

Attraverso la luce avvertiamo il paesaggio, l'architettura e gli spazi in cui abitiamo, e stimoliamo i nostri sensi e le nostre percezioni.

Ognuno di noi ha un'identità propria, uno sguardo unico e una maniera soggettiva di percepire la realtà.

La vocazione di VIBIA è di sviluppare soluzioni adeguate alle esigenze delle persone in contesti diversi. La nostra missione è di perfezionare l'interazione che le persone hanno con il proprio ambiente e il proprio benessere visivo ed emotivo.

Nel processo di progettazione di uno spazio, l'illuminazione diventa un elemento trasversale alla relativa architettura, arredamento interno ed uso. Con le nostre lampade desideriamo contribuire a creare l'atmosfera ideale, affinché vivere ogni spazio sia un'esperienza completa ed unica.

Collaborazione

Accompagniamo i professionisti "creatori di spazi", immaginiamo insieme a loro e condividiamo le reciproche sensibilità.

Ci piace prestare attenzione alla realtà delle persone, per poter proporre soluzioni adeguate e, sovente, inaspettate.

Siamo complici del processo creativo di designer di illuminazione, architetti, interior designer ed artisti, nella missione condivisa di creare spazi in cui vivere meglio. Desideriamo che la nostra proposta di prodotti stimoli l'ispirazione, contribuendo a sorprendere, a spingersi oltre e ad esplorare nuovi orizzonti.

The Vibia experience

Offriamo una proposta unica di prodotti e soluzioni, stimolante per i professionisti dell'illuminazione e della creazione di spazi. L'esperienza continua su [vibia.com](#) uno spazio che ci consente di essere costantemente collegati per generare e condividere ispirazione, ottenere informazioni in modo facile ed efficiente, ed essere sempre in contatto.

I nostri strumenti online integrano prodotti e spazi, agevolano il lavoro e costituiscono un sistema in grado di aiutarci a utilizzare la luce e le lampade come una magnitudine modellabile nello spazio, in modo da adeguarsi alle necessità ed ai fini del progetto.

E, ovviamente, le persone sono prioritarie, sempre con l'impegno di un rapporto personale stretto attraverso i nostri team locali e fornendo l'assistenza necessaria nel corso dell'intero progetto. Offriamo un modo di lavorare genuino, cortese ed efficiente.

Vibia, un ecosistema proprio

Il nostro modello gode di una configurazione propria, in cui cerchiamo di far convivere ed ampliare il talento, in un'organizzazione in cui creatività e innovazione sono un atteggiamento che mette in discussione quanto prestabilito e cerca continuamente di apportare nuovi concetti e migliorie.

Nell'ecosistema Vibia, ci piace ascoltare, capire e risolvere, condividere dubbi ed immaginare spazi ed ambienti abitati, proponendo soluzioni ottimali ed uniche.

We live for the thrilling challenge of developing top-class products and supporting and engage to a global community.

(Viviamo per l'emozionante sfida di sviluppare prodotti di prima classe e di offrire supporto e impegno a una comunità globale)

Light is creation

La lumière crée, façonne et donne la vie.

C'est à travers la lumière que nous percevons le paysage, l'architecture et les espaces que nous habitons. C'est elle qui stimule nos sens et nos perceptions.

Chacun de nous a sa propre identité, son regard personnel sur les choses et une perception subjective de la réalité.

VIBIA a pour vocation d'apporter des solutions qui s'adaptent aux besoins de chacun, et ce dans différents contextes. Nous souhaitons améliorer l'interaction entre les individus et leur environnement, en contribuant à leur bien-être visuel et émotionnel.

Dans toute conception d'espace, l'éclairage constitue un élément transversal de l'architecture, de l'aménagement intérieur et de l'usage qui en sera fait. À travers les luminaires que nous proposons, nous entendons contribuer à créer l'atmosphère idéale, pour que l'expérience vécue au sein de chaque espace soit à la fois riche et singulière.

Collaboration

Nous accompagnons les professionnels "créateurs d'espaces" en imaginant avec eux, dans un souci de partage des sensibilités.

Nous sommes attentifs aux réalités des individus afin de proposer des solutions adéquates qui se révèlent, bien souvent, inespérées.

Nous nous faisons complices du processus de création des concepteurs lumière, des architectes, des architectes d'intérieur et des artistes, animés, comme eux, du désir de créer des espaces où l'on puisse vivre mieux. Nous souhaitons que les gammes de produits que nous proposons stimulent leur inspiration, pour ainsi contribuer à surprendre, à repousser les limites, à explorer de nouveaux horizons.

The Vibia experience

Nous offrons une gamme de produits et de solutions unique, apte à stimuler l'imagination des professionnels de l'éclairage et de la création d'espaces. L'expérience se prolonge sur le site [vibia.com](#), un espace qui nous permet d'être connectés en permanence pour susciter et partager l'inspiration, fournir facilement et efficacement les informations nécessaires et rester constamment en communication.

Ces outils online présentent des produits et des espaces, facilitent le travail et forment un dispositif qui aide à utiliser lumière et luminaires comme des éléments d'envergure modelables dans l'espace, en les adaptant aux besoins et à l'esprit du projet.

Et puisque l'essentiel ce sont bien évidemment les individus, nous nous engageons à entretenir une relation personnalisée de proximité par le biais de nos équipes locales en fournissant, tout au long du projet, l'accompagnement nécessaire.

Nous défendons des échanges professionnels authentiques, agréables et efficaces.

Vibia: tout un écosystème en soi

Nous construisons peu à peu notre propre modèle au sein duquel nous souhaitons voir cohabiter les talents et les encourager, où créativité et innovation constituent les fondements mêmes d'une attitude qui questionne les acquis, à la recherche constante d'améliorations et de nouveaux concepts.

Au sein de l'écosystème Vibia, nous aimons écouter, comprendre et répondre, partager les réflexions et imaginer des espaces et des lieux de vie, en apportant des solutions optimales et singulières.

Notre raison d'être : relever le défi passionnant de créer des produits d'excellence, en défendant la communauté d'idées au sein de laquelle nous sommes engagés.

11 Pendants

- 12 Algorithm
- 98 Ameba
- 102 Ameba Single
- 104 Big
- 50 Cosmos
- 118 Curtain
- 20 Flamingo
- 82 Halo Circular
- 78 Halo Lineal
- 106 Jazz
- 54 Match
- 74 Mayfair
- 86 North
- 66 Rhythm Horizontal
- 70 Rhythm Vertical
- 60 Skan
- 108 Slim
- 90 Vol
- 94 Warm
- 114 Wind
- 30 Wireflow
- 46 Wireflow Chandelier
- 40 Wireflow Freeform
- 36 Wireflow Lineal

127 Floor

- 160 Balance
- 146 I. Cono
- 156 Jazz
- 164 Mayfair
- 136 North
- 128 Pin
- 142 Skan
- 132 Suite
- 152 Swing
- 148 Warm

169 Table

- 184 Flex
- 198 I. Cono
- 192 Jazz
- 194 Join
- 170 Mayfair
- 176 Pin
- 180 Suite
- 188 Swing
- 202 Warm

209 Ceiling

- 230 Big
- 234 Big Built-in
- 218 Centric
- 254 Domo
- 258 Funnel
- 222 Link
- 226 Link XXL
- 246 Plus
- 238 Puck
- 268 Quadra Ice
- 262 Scotch
- 266 Stage
- 210 Up
- 242 45°

271 Wall

- 308 Alpha
- 316 Centric
- 324 Fold Built-in
- 320 Fold Surface
- 334 Funnel
- 302 I. Cono
- 298 Micro
- 342 Milenium
- 272 North
- 288 Origami
- 282 Pin
- 326 Puck
- 304 Puck Wall Art
- 330 Scotch
- 276 Set
- 346 Sparks
- 293 Suite
- 338 Swing

351 Outdoor

- 364 Bamboo
- 372 Boxes
- 382 Break
- 360 Brisa
- 414 Empty
- 390 Halley
- 352 June
- 418 Meridiano
- 394 Micro
- 410 Origami
- 406 Palo Alto
- 396 Plis Outdoor
- 392 Plus
- 400 Scotch
- 402 Tree
- 376 Wind

425 Professional Area

426 Technical information

466 Item index / Índice referencias

468 Glossary / Glosario

469 Item recoding / Nueva codificación artículos

471 Acknowledgements / Agradecimientos

Pendants

Composing Light,
Spreading The Light,
Soft Creation...

Composing Light

The opportunity of composing light in space, adapting to the unique requirements of each environment and the people who inhabit them, creating evocative ambiences charged with sensuality.

The notes and the silences, like light and shade form part of this subtle yet complex language that defines these compositions.



Spreading The Light

The light source is integrated with the product, adapting to its surrounding dimensions like liquid light, form and function freely expressed.



Soft Creation

Algorithms that help us identify the axioms which through logic help to order the chaos, establishing relationships between product and space, geometry, position in space and movement.

Pendants



Algorithm
pag. 12



Ameba
pag. 98



AmebaSingle
pag. 102



Big
pag. 104



Cosmos
pag. 50



Curtain
pag. 118



Flamingo
pag. 20

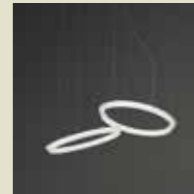

HaloCircular
pag. 82



HaloLineal
pag. 78



Jazz
pag. 106



Match
pag. 54



Mayfair
pag. 74



North
pag. 86



RhythmHorizontal
pag. 66



RhythmVertical
pag. 70



Skan
pag. 60



Slim
pag. 108



Vol
pag. 90



Warm
pag. 94



Wind
pag. 114



Wireflow
pag. 30



WireflowLineal
pag. 36



WireflowFreeForm
pag. 40



WireflowChandelier
pag. 46

Algorithm

Design by Toan Nguyen.



Like light drops, suspended in the air. Mathematical order provides a magical harmony with an astonishing range of permutations and compositions. Can be customized to suit any space.

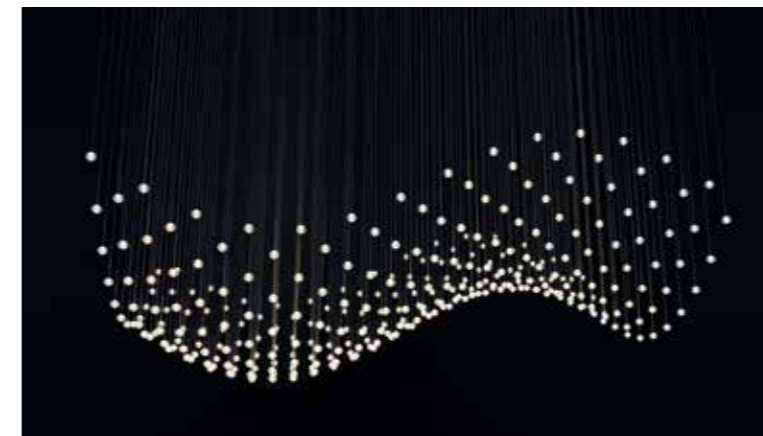
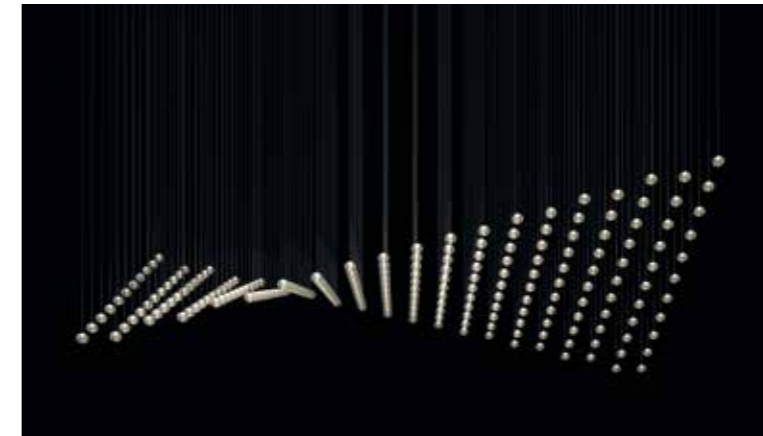

Algorithm



Create your product configuration quickly and easily at vibia.com

Go to vibia.com and discover the quickest, most effective way to configure a unique Algorithm design.

Crea tu configuración de producto de manera rápida y fácil en vibia.com

Entra en vibia.com y descubre la manera más rápida y eficiente de configurar un diseño único de Algorithm.

Algorithm



0875 18 /1A.



0885 18 /1A.



0860 18/1A.



0825 18 /1A.

Algorithm

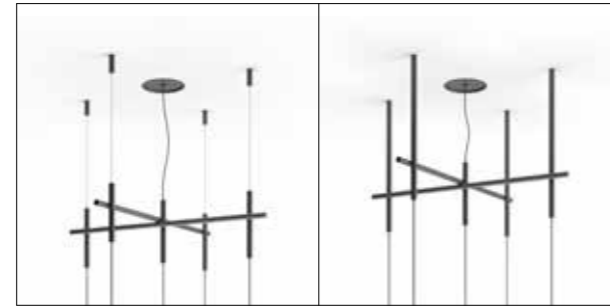

Adjustable cable installation /
Instalación con cable ajustable.

Rigid stem installation.
Fixed at 25cm /
Instalación rígida con tubos.
Fijación a 25 cm.

Blowed glass balls / Polycarbonate diffuser / Bolas de vidrio soplado / Difusor de policarbonato.



Surface and built-in canopy / Florón de superficie y empotrable.	0820 18 /1A. 0820 93 /1A.	1 x LED 3,15W 1050mA.	
	0825 18 /1A. 0835 18 /1A 0825 93 /1A. 0835 93 /1A.	10 x LED 3,15W 1050mA.	
	0830 18 /1A. 0830 93 /1A.	6 x LED 3,15W 1050mA.	
	0840 18 /1A. 0845 18 /1A. 0840 93 /1A. 0845 93 /1A.	14 x LED 3,15W 1050mA.	
	0850 18 /1A. 0850 93 /1A.	29 x LED 3,15W 1050mA.	
Surface and built-in canopy. Adjustable cable installation or rigid stem installation (fixed at 25 cm) / Florón de superficie y empotrable. Fijación a techo con cables (ajustable) o rígida (fija a 25 cm).	0855 18 /1A. 0855 93 /1A.	5 x LED 3,15W 1050mA.	● 18 Matt graphite lacquer / Lacado grafito mate.
	0860 18 /1A. 0860 93 /1A.	13 x LED 3,15W 1050mA.	● 93 Matt white lacquer / Lacado blanco mate.
	0865 18 /1A. 0865 93 /1A.	25 x LED 3,15W 1050mA.	
	0870 18 /1A. 0870 93 /1A.	15 x LED 3,15W 1050mA.	
	0875 18 /1A. 0875 93 /1A.	24 x LED 3,15W 1050mA.	
	0880 18 /1A. 0880 93 /1A.	12 x LED 3,15W 1050mA.	
	0885 18 /1A. 0885 93 /1A.	24 x LED 3,15W 1050mA.	

/1A.
2700 °K.
Dimmable:
DALI + 1-10V + Push.

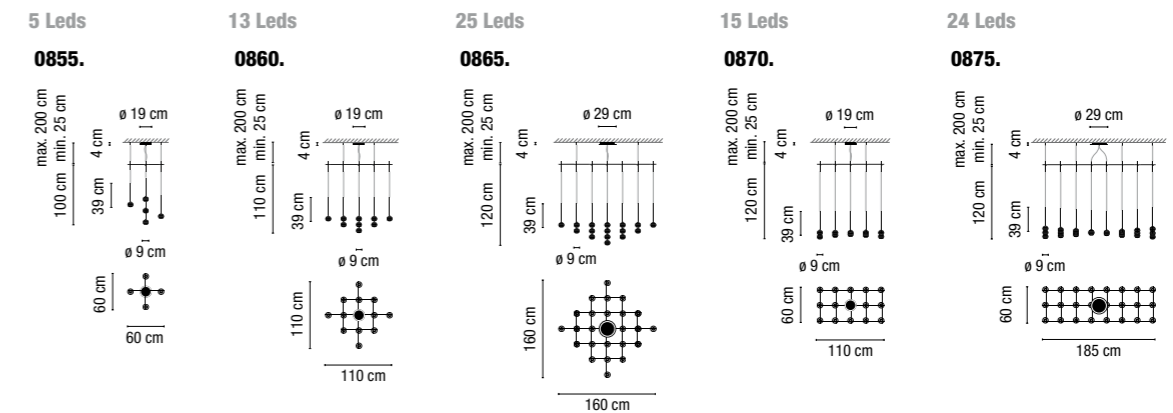
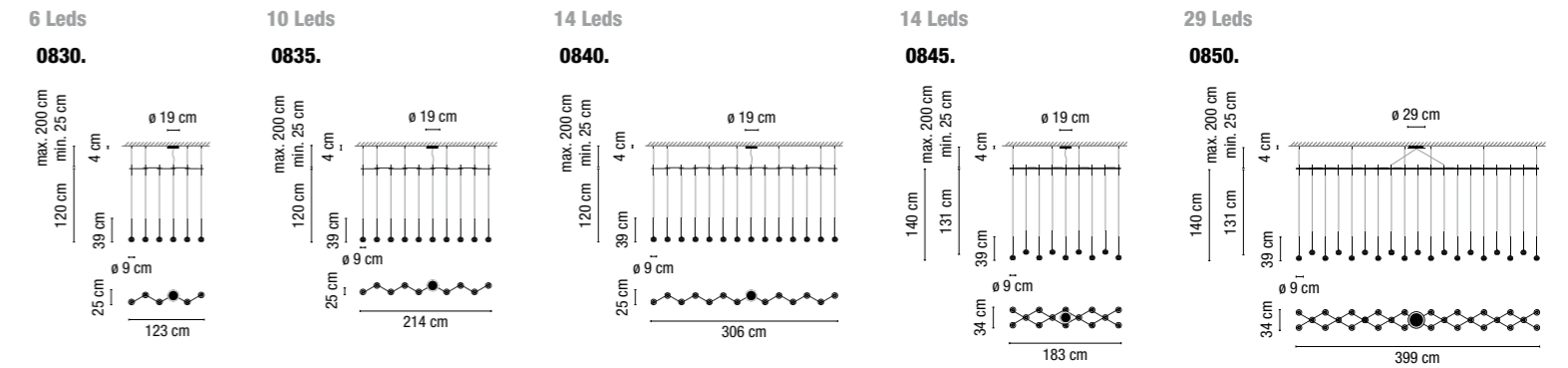
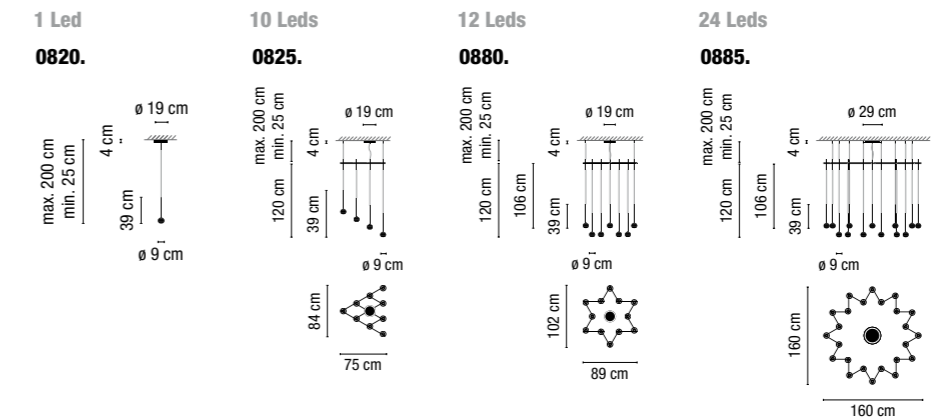

Check additional product specifications at the end of this catalogue: Technical information /
Consultar especificaciones adicionales del producto al final del catálogo: Información Técnica.

Flamingo

Design by Antoni Arola



The challenge consisted of projecting light onto the shade rather than directly from the light source. The result, an ethereal effect, where the fitting and its lighting are deconstructed.



1530 18 /1B. 1550 93 /1B. 1560 18 /1B.

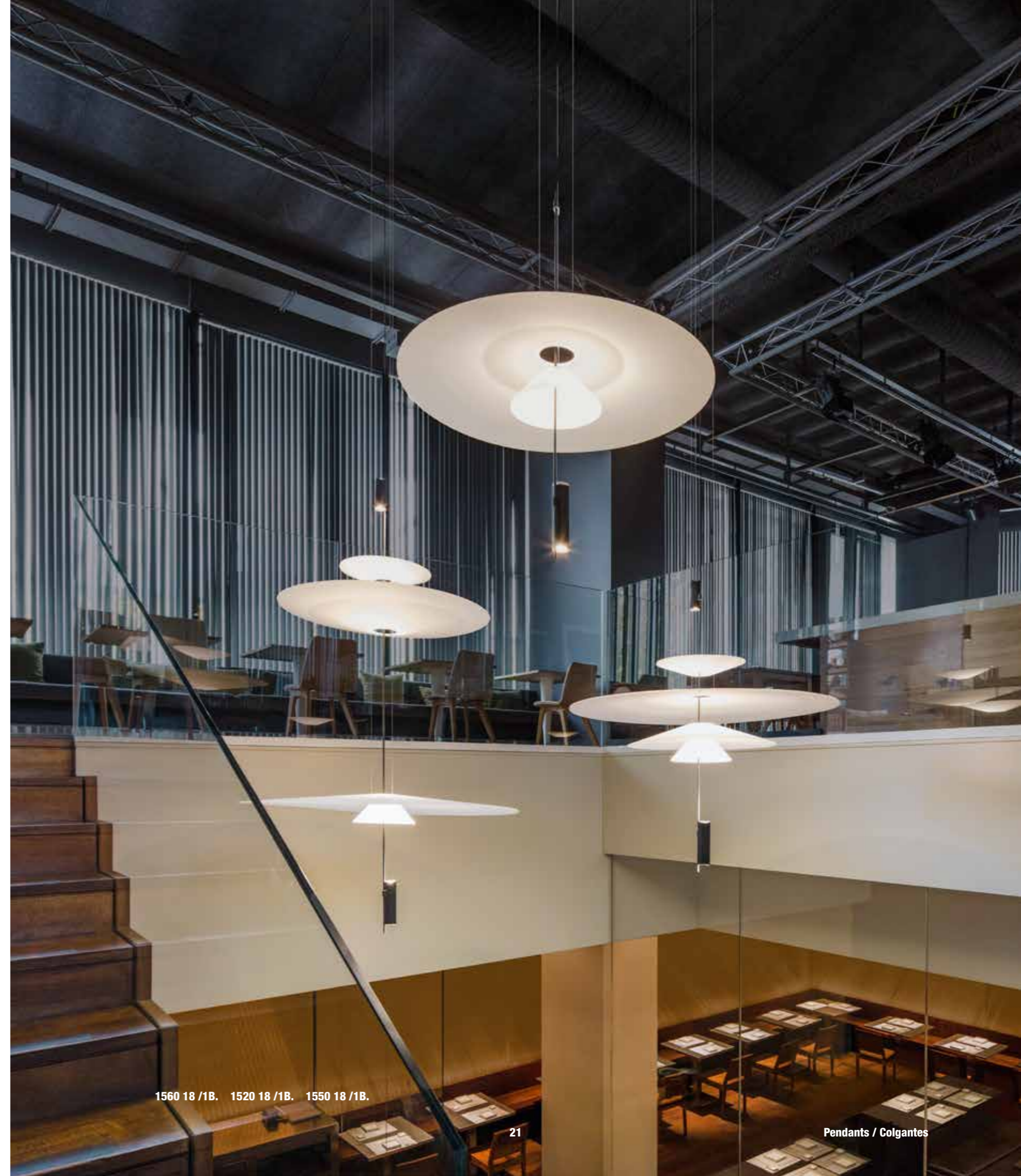

1560 18 /1B. 1520 18 /1B. 1550 18 /1B.



1515 20 /15.

Flamingo



1510 20 /1B.

Flamingo



1520 93 /1B.



1520 18 /1B.
1510 93 /1B.



1520 18 /1B.

Flamingo

1540 18 / 1B.



1540 18 / 1B.

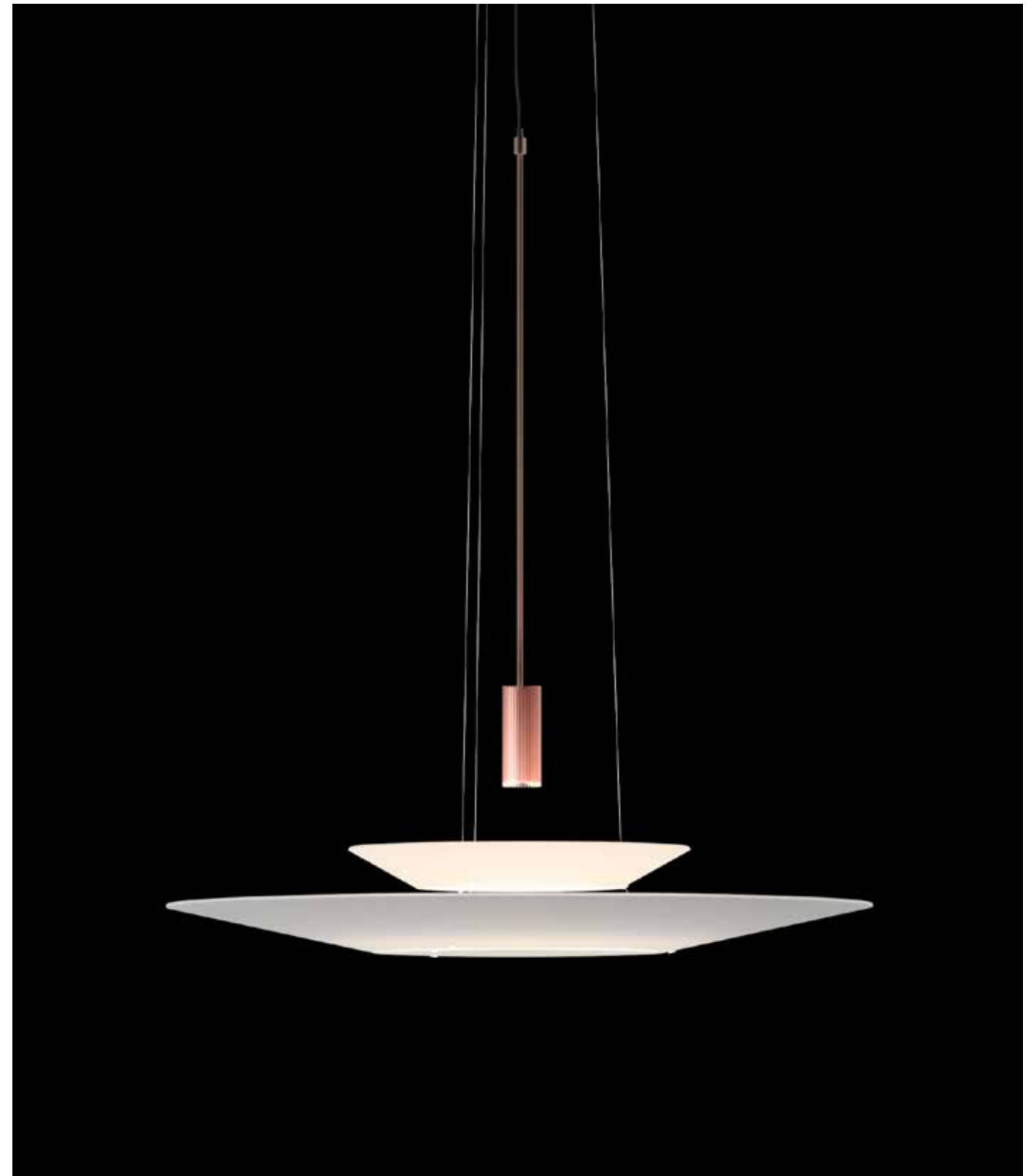

1540 67 / 1B.



Flamingo

1510.

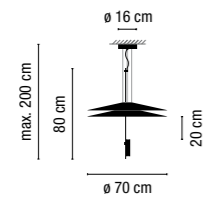

1515.

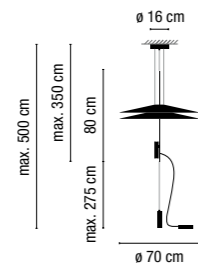

1520.

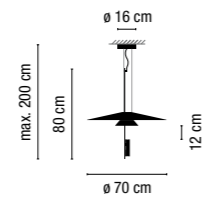

1525.

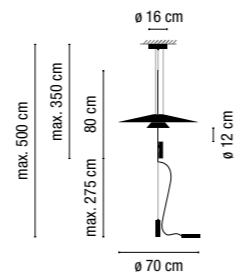

1530.

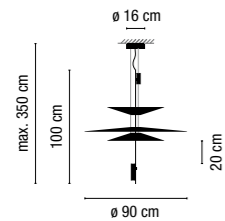

1535.

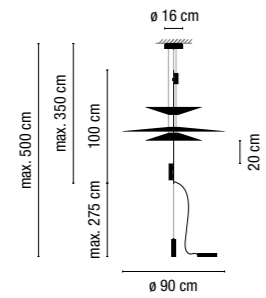

1540.

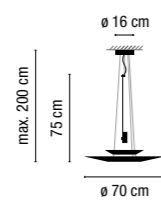

1550.

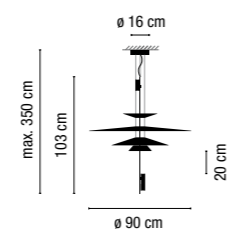

1560.

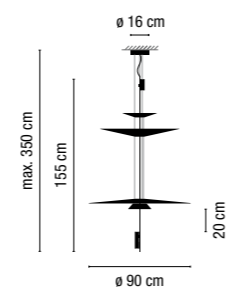

Methacrylate diffuser / Difusor de metacrilato.

<p>1510 18 /1B. 1520 18 /1B. 1510 20 /1B. 1520 20 /1B. 1510 67 /1B. 1520 67 /1B. 1510 93 /1B. 1520 93 /1B.</p>	<p>2 x LED 5,6W 500mA.</p>	<p>LED IP20 CE Bi-volt</p>	<p>18 Matt graphite lacquer / Lacado grafito mate. 20 Matt gold / Oro satinado mate. 67 Gloss copper / Cobre brillo. 93 Matt white lacquer / Lacado blanco mate.</p>	<p>/1B. 2700 °K. Dimmable: 1-10V + Push.</p>
<p>1530 18 /1B. 1550 18 /1B. 1560 18 /1B. 1530 20 /1B. 1550 20 /1B. 1560 20 /1B. 1530 67 /1B. 1550 67 /1B. 1560 67 /1B. 1530 93 /1B. 1550 93 /1B. 1560 93 /1B.</p>	<p>3 x LED 5,6W 500mA.</p>	<p>LED IP20 CE</p>		
<p>1540 18 /1B. 1540 20 /1B. 1540 67 /1B. 1540 93 /1B.</p>	<p>1 x LED 5,6W 500mA.</p>	<p>LED IP20 CE Bi-volt</p>		
<p>1515 18 /15. 1525 18 /15. 1515 20 /15. 1525 20 /15. 1515 67 /15. 1525 67 /15. 1515 93 /15. 1525 93 /15.</p>	<p>2 x LED 5,6W 500mA.</p>	<p>LED IP20 CE Bi-volt</p>	<p>18 Matt graphite lacquer / Lacado grafito mate. 20 Matt gold / Oro satinado mate. 67 Gloss copper / Cobre brillo. 93 Matt white lacquer / Lacado blanco mate.</p>	<p>/15. 2700 °K. Dimmable: Push. With plug / Con enchufe.</p>
<p>1535 18 /15. 1535 20 /15. 1535 67 /15. 1535 93 /15.</p>	<p>3 x LED 5,6W 500mA.</p>	<p>LED IP20 CE</p>		

Check additional product specifications at the end of this catalogue: Technical information /
Consultar especificaciones adicionales del producto al final del catálogo: Información Técnica.



Wireflow

Design by Arik Levy



Wireflow is both presence and absence, transparency and luminosity, light and fluidity.



0305 04 /1A. 0310 04 /1A. 0300 04 /1A.



0299 04 /1A.



0305 04 /1A.

0310 04 /1A.



0313 04 /1A.

Wireflow

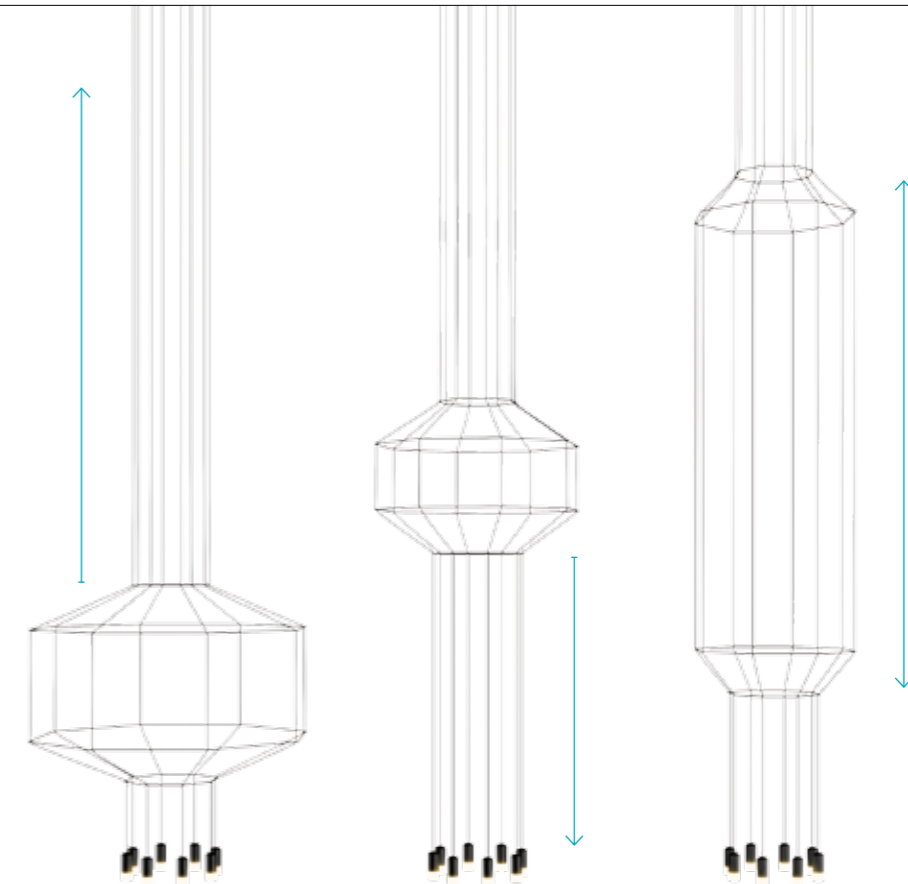

Create your product configuration quickly and easily at vibia.com

Go to vibia.com and discover the quickest, most effective way to configure a unique Wireflow design.

Crea tu configuración de producto de manera rápida y fácil en vibia.com

Entra en vibia.com y descubre la manera más rápida y eficiente de configurar un diseño único de Wireflow.

Wireflow

4 Leds

0309. *0409.

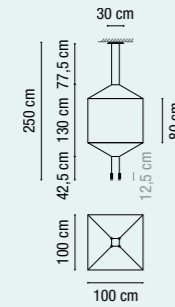

0310. *0410.

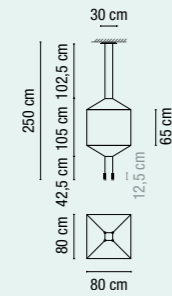

0311. *0411.

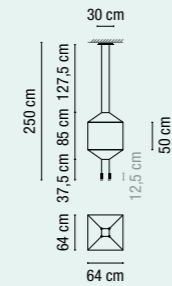

0312. *0412.

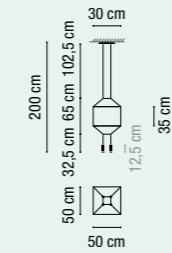

0313. *0413.

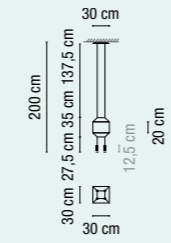

6 Leds

0304. *0404.

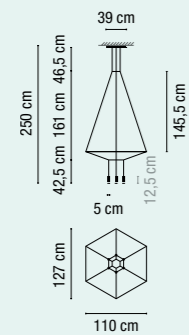

0305. *0405.

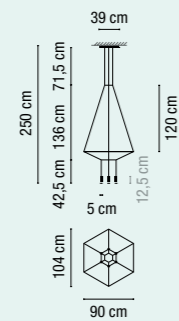

0306. *0406.

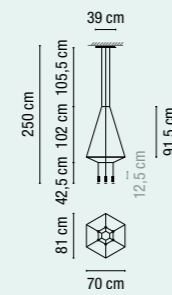

0307. *0407.

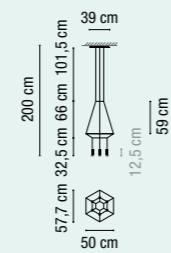

0308. *0408.

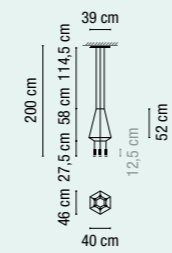

8 Leds

0299. *0399.

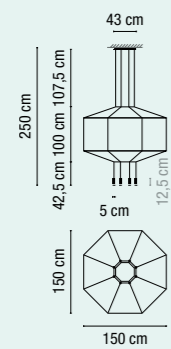

0300. *0400.

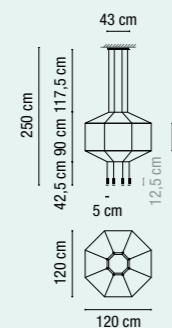

0301. *0401.

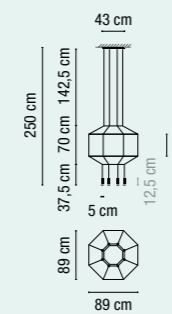

0302. *0402.

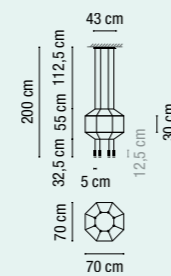

0303. *0403.

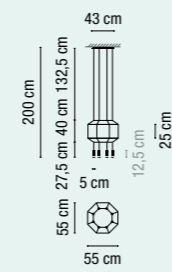

Pressed-glass diffuser /
Difusor de vidrio prensado.

0309 04 /1A. 0312 04 /1A.
0310 04 /1A. 0313 04 /1A.
0311 04 /1A.

⊗ 4 x LED 4,5W 350mA.

0304 04 /1A. 0307 04 /1A.
0305 04 /1A. 0308 04 /1A.
0306 04 /1A.

⊗ 6 x LED 4,5W 350mA.

0299 04 /1A. 0302 04 /1A.
0300 04 /1A. 0303 04 /1A.
0301 04 /1A.

⊗ 8 x LED 4,5W 350mA.

0409 04 /1A. 0412 04 /1A.
0410 04 /1A. 0413 04 /1A.
0411 04 /1A.

⊗ 4 x LED 4,5W 350mA.

0404 04 /1A. 0407 04 /1A.
0405 04 /1A. 0408 04 /1A.
0406 04 /1A.

⊗ 6 x LED 4,5W 350mA.

0399 04 /1A. 0402 04 /1A.
0400 04 /1A. 0403 04 /1A.
0401 04 /1A.

⊗ 8 x LED 4,5W 350mA.

● 04 Black lacquer /
Lacado negro.

/1A.
2700 °K.
Dimmable:
DALI + 1-10V + Push.



*
Aluminum body height 9 cm /
Altura cuerpo de aluminio 9 cm.
Without pressed-glass diffuser /
Sin difusor de vidrio prensado.

Check additional product specifications at the end of this catalogue: Technical information /
Consultar especificaciones adicionales del producto al final del catálogo: Información Técnica.



WireflowLineal

Design by Arik Levy



The captivating graphic essence of this light fitting is defined by its two dimensional form creating a transparent effect.



0332 04 /1A.



0340 04 /1A.



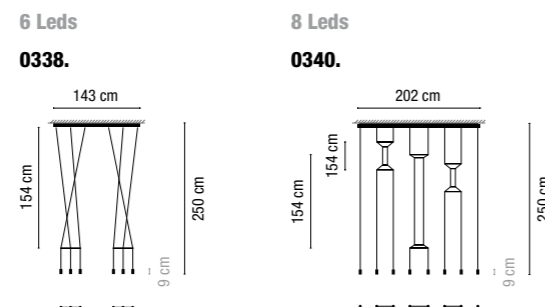
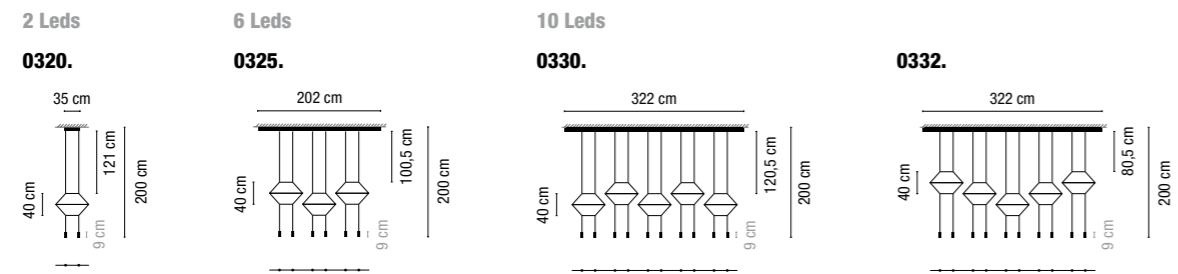

LED IP20 CE Bi-volt

0320 04 /1B.	⊗ 2 x LED 4,5W 350mA.	04 Black lacquer / Lacado negro.	/1B. 2700 °K. Dimmable: 1-10V + Push.
0325 04 /1B.	⊗ 6 x LED 4,5W 350mA.		
0330 04 /1B. 0332 04 /1B.	⊗ 10 x LED 4,5W 350mA.		
0338 04 /1B.	⊗ 6 x LED 4,5W 350mA.		
0340 04 /1B.	⊗ 8 x LED 4,5W 350mA.		

Check additional product specifications at the end of this catalogue: Technical information / Consultar especificaciones adicionales del producto al final del catálogo: Información Técnica.

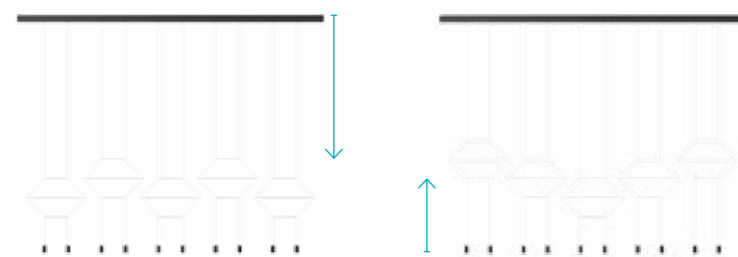

Create your product configuration quickly and easily at vibia.com

Go to vibia.com and discover the quickest, most effective way to configure a unique Wireflow design.

Crea tu configuración de producto de manera rápida y fácil en vibia.com

Entra en vibia.com y descubre la manera más rápida y eficiente de configurar un diseño único de Wireflow.



0338 04 /1A.

WireflowFreeForm

Design by Arik Levy



Providing light where it's needed. Feel free to direct the flow.



0347 04 /1A. 0348 04 /1A.



0364 04 /1A.



0355 04 /1A. 0350 04 /1A.



0353 04 /1A.



0355 04 1/A.



0360 04 /1A.



0360 04 /1A.

WireflowFreeForm

LED IP20 CE Bi-volt

	Pressed-glass diffuser / Difusor de vidrio prensado.	0348 04 /15.	☉ 1 x LED 4,5W 350mA.	● 04 Black lacquer / Lacado negro.	/15. 2700 °K. Dimmable: Push.
	* Aluminum body height 9 cm / Altura cuerpo de aluminio 9 cm. Without pressed-glass diffuser / Sin difusor de vidrio prensado.	0347 04 /15.	☉ 1 x LED 4,5W 350mA.	● 04 Black lacquer / Lacado negro.	With plug. Dimmer switch on the canopy / Con enchufe. Interruptor con regulador de intensidad.
	Pressed-glass diffuser / Difusor de vidrio prensado.	0345 04 /1B.	☉ 1 x LED 4,5W 350mA.	● 04 Black lacquer / Lacado negro.	/1B. 2700 °K. Dimmable: 1-10V + Push.
		0349 04 /1A.	☉ 2 x LED 4,5W 350mA.		
		0350 04 /1A.	☉ 3 x LED 4,5W 350mA.		
		0351 04 /1A.	☉ 4 x LED 4,5W 350mA.		
		0353 04 /1A.	☉ 5 x LED 4,5W 350mA.		
		0355 04 /1A.	☉ 6 x LED 4,5W 350mA.		
		0356 04 /1A.	☉ 7 x LED 4,5W 350mA.		
		0358 04 /1A.	☉ 8 x LED 4,5W 350mA.		
0360 04 /1A.	☉ 9 x LED 4,5W 350mA.				
	* Aluminum body height 9 cm / Altura cuerpo de aluminio 9 cm. Without pressed-glass diffuser / Sin difusor de vidrio prensado.	0361 04 /1B.	☉ 1 x LED 4,5W 350mA.	● 04 Black lacquer / Lacado negro.	/1B. 2700 °K. Dimmable: 1-10V + Push.
		0362 04 /1A.	☉ 2 x LED 4,5W 350mA.		
		0363 04 /1A.	☉ 3 x LED 4,5W 350mA.		
		0364 04 /1A.	☉ 4 x LED 4,5W 350mA.		
		0365 04 /1A.	☉ 5 x LED 4,5W 350mA.		
		0366 04 /1A.	☉ 6 x LED 4,5W 350mA.		
		0367 04 /1A.	☉ 7 x LED 4,5W 350mA.		
		0368 04 /1A.	☉ 8 x LED 4,5W 350mA.		
		0369 04 /1A.	☉ 9 x LED 4,5W 350mA.		

With plug / Con enchufe

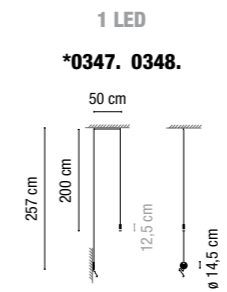

Customizable layout / Libre Disposición

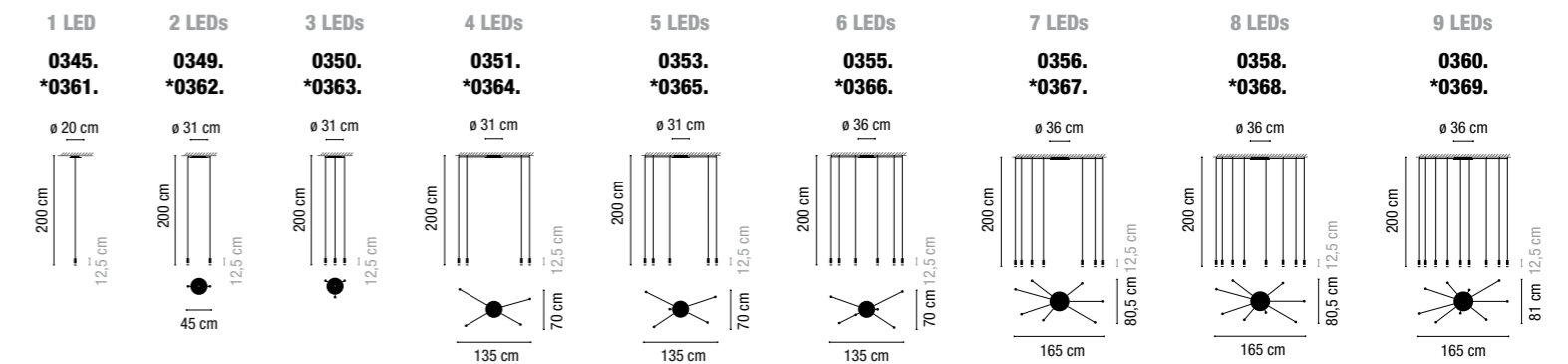

Create your product configuration quickly and easily at vibia.com

Go to vibia.com and discover the quickest, most effective way to configure a unique Wireflow design.

Crea tu configuración de producto de manera rápida y fácil en vibia.com

Entra en vibia.com y descubre la manera más rápida y eficiente de configurar un diseño único de Wireflow.

Check additional product specifications at the end of this catalogue: Technical information /
Consultar especificaciones adicionales del producto al final del catálogo: Información Técnica.



Wireflow Chandelier

Design by Arik Levy



An authentic light sculpture floating in space.



0374 04 /1A.

Create your product configuration quickly and easily at vibia.com

Go to vibia.com and discover the quickest, most effective way to configure a unique Wireflow design.

Crea tu configuración de producto de manera rápida y fácil en vibia.com

Entra en vibia.com y descubre la manera más rápida y eficiente de configurar un diseño único de Wireflow.



Wireflow Chandelier



0315 04 /1A.

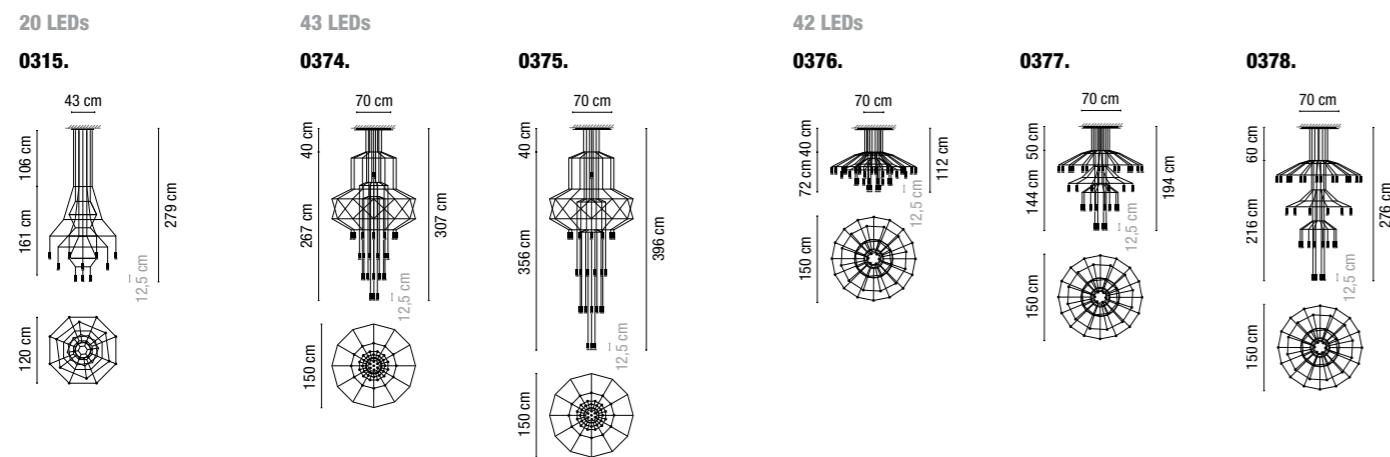

Pressed-glass diffuser / Difusor de vidrio prensado.

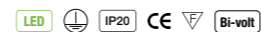

0315 04 /1A.	⊗ 20 x LED 4,5W 350mA.	● 04 Black lacquer / Lacado negro.	/1A. 2700 °K. Dimmable: DALI + 1-10V + Push.
0374 04 /1A. 0375 04 /1A.	⊗ 43 x LED 4,5W 350mA.		
0376 04 /1A. 0377 04 /1A. 0378 04 /1A.	⊗ 42 x LED 4,5W 350mA.		

Check additional product specifications at the end of this catalogue: Technical information / Consultar especificaciones adicionales del producto al final del catálogo: Información Técnica.



0378 04 /1A.



Cosmos

Design by Lievore, Altherr, Molina.



Cosmos creates an optical illusion, a spatial illusion, an illusion of otherness based on a series of opaque objects that provide the gift of perfect light.



2501 62 /1B. 2500 14 /1B.

2515 62 /1A.



2501 14 /1B.
2500 62 /1B.
2511 66 /1A.

Cosmos

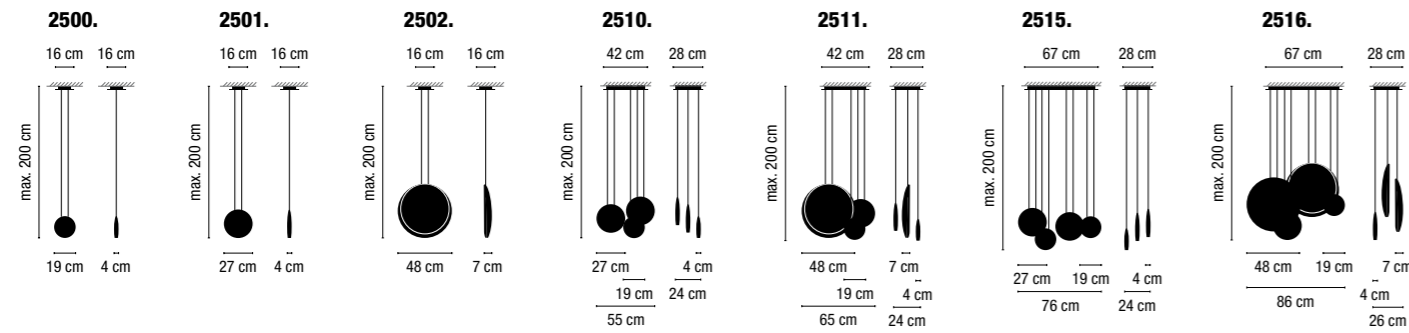

Polycarbonate diffuser / Difusor de policarbonato.

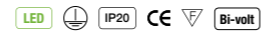

2500 14 /1B. 2501 14 /1B. 2500 62 /1B. 2501 62 /1B. 2500 66 /1B. 2501 66 /1B.	☉ 1 x LED 4,5W 350mA.	● 14 Matt chocolate lacquer / Lacado marrón oscuro mate. ● 62 Matt green lacquer / Lacado verde mate. ● 66 Matt light-grey lacquer / Lacado gris claro mate.	/1B. 2700 °K. Dimmable: 1-10V + Push.
2502 03 /1B.	☉ 1 x LED 4,5W 350mA. ☉ 1 x LED 1W 350mA.	● 03 Matt white lacquer / Lacado blanco mate.	
2510 62 /1A.	☉ 3 x LED 4,5W 350mA.	● 62 Matt green lacquer, matt chocolate lacquer and matt light-grey lacquer / Lacado verde mate, lacado marrón oscuro mate y lacado gris claro mate.	/1A. 2700 °K. Dimmable: DALI + 1-10V + Push.
2511 62 /1A. 2511 66 /1A.	☉ 3 x LED 4,5W 350mA. ☉ 1 x LED 1W 350mA.	● 62 Matt green lacquer, matt white lacquer and matt chocolate lacquer / Lacado verde mate, lacado blanco mate y lacado marrón oscuro mate. ● 66 Matt light-grey lacquer, matt white lacquer and matt chocolate lacquer / Lacado gris claro mate, lacado blanco mate y lacado marrón oscuro mate.	
2515 62 /1A.	☉ 4 x LED 4,5W 350mA.	● 62 Matt green lacquer, matt light-grey lacquer and matt chocolate lacquer / Lacado verde mate, lacado gris claro mate y lacado marrón oscuro mate.	
2516 62 /1A.	☉ 4 x LED 4,5W 350mA. ☉ 2 x LED 1W 350mA.	● 62 Matt green lacquer, matt white lacquer and matt chocolate lacquer / Lacado verde mate, lacado blanco mate y lacado marrón oscuro mate.	

Check additional product specifications at the end of this catalogue: Technical information /
 Consultar especificaciones adicionales del producto al final del catálogo: Información Técnica.



2511 66 /1A. 2500 62 /1B.

Match

Design by Jordi Vilardell & Meritxell Vidal.



The starting point was to create compositions of chaotic harmony, of a sculptural character. Each light fitting customized to its space.



Match

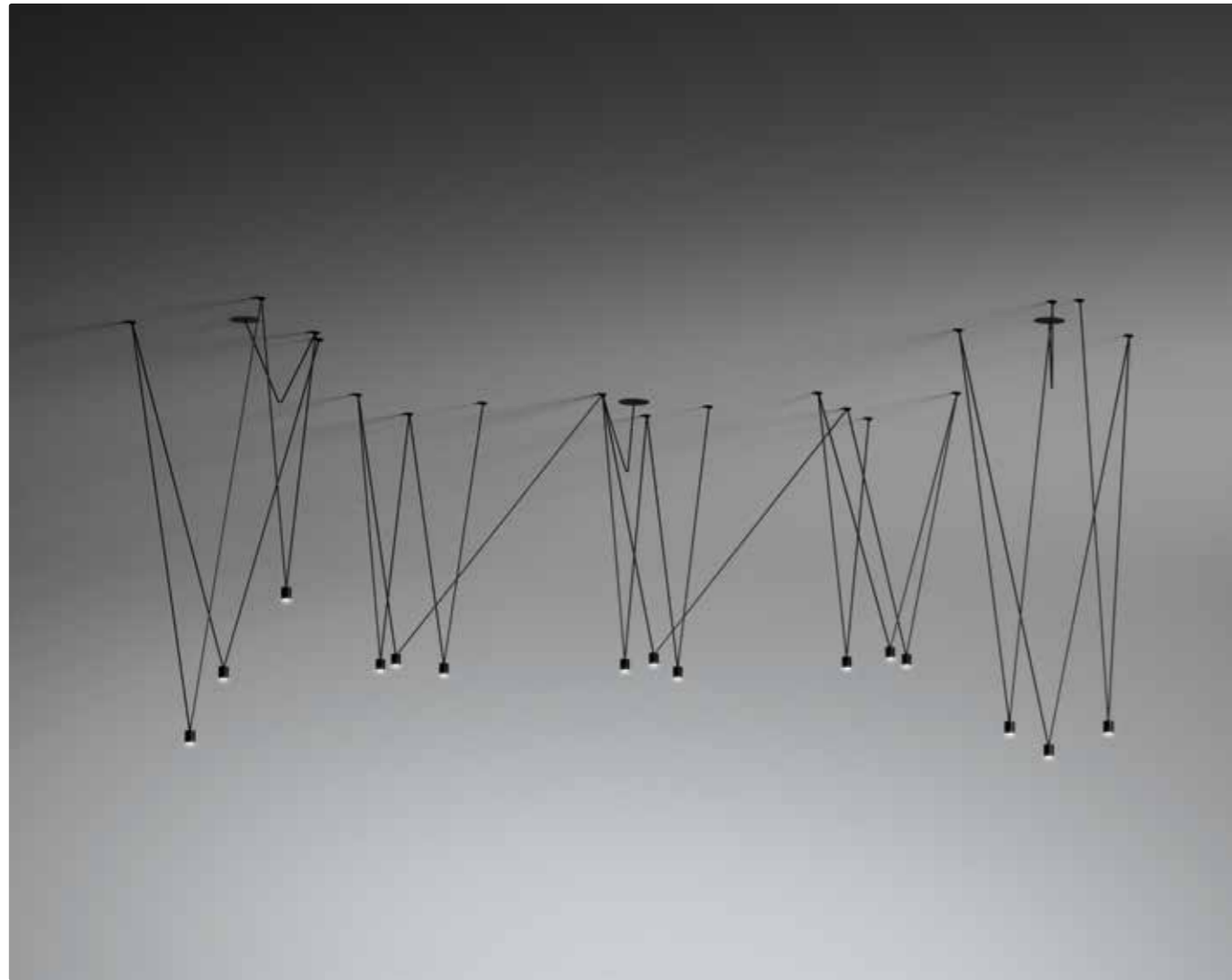

Match

Built-in installation

-Electrical connection finials: the minimum height is 10 cm and the dimension of the cut-out is 10,5 cm.
-Nodes: the minimum height is 12 cm and the dimension of the cut-out is 4,5 cm.

Instalación empotrada

-Florón de conexión eléctrica: la altura mínima es de 10 cm y el diámetro de corte es 10,5 cm.
-Nudos: la altura mínima es de 12 cm y el diámetro de corte es 4,5 cm.



Aluminum diffuser / Difusor de aluminio.

LED IP20 CE \varnothing 4,5 cm \varnothing 10,5 cm

LED 2,1W 700mA.

- 03 Matt white lacquer / Lacado blanco mate.
- 18 Matt graphite grey / Lacado gris grafito.

/1A.
2700 °K.
Dimmable: DALI + 1-10V + Push.

Check additional product specifications at the end of this catalogue: Technical information / Consultar especificaciones adicionales del producto al final del catálogo: Información Técnica.



Create your product configuration quickly and easily at vibia.com

Go to vibia.com and discover the quickest, most effective way to configure a unique Match luminaire design.

Crea tu configuración de producto de manera rápida y fácil en vibia.com

Entra en vibia.com y descubre la manera más rápida y eficiente de configurar un diseño único de Match.

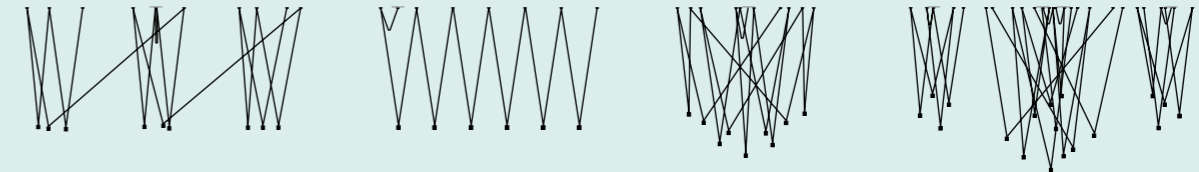

Skan

Design by Lievore, Altherr, Molina.



Reintroducing the concept of a hanging lamp consisting on a conical shade with a light inside, updated using contemporary technology. We are not just evolving tradition, but fine tuning it.



0270 18 /12.



0282 18 /1B.

0271 18 /1B.



0271 18 /1B.



0271 18 /1B.



0276 03 /1B.



Skán

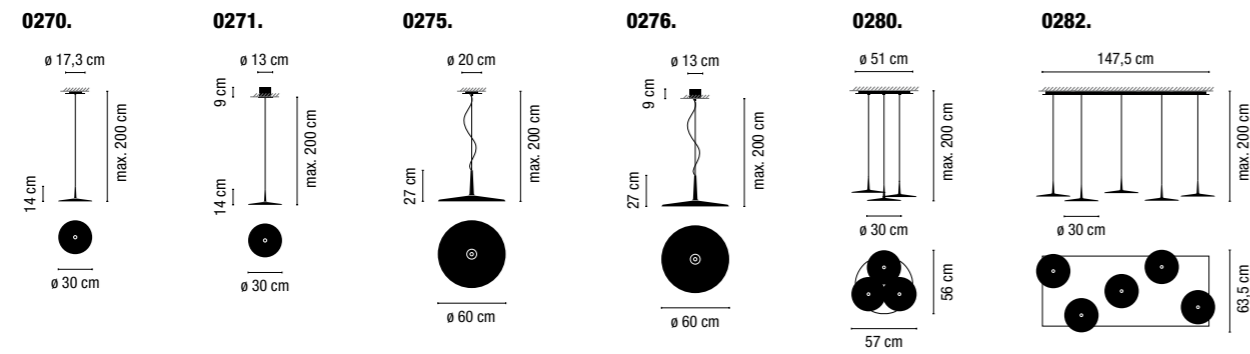

Methacrylate diffuser / Difusor de metacrilato.

Surface / Superficie.	0270 03 /12. 0270 06 /12. 0270 18 /12.	1 x LED 9W 350mA.	LED IP20 CE Bi-volt	<ul style="list-style-type: none"> 03 Matt white lacquer / Lacado blanco mate. 06 Matt red lacquer / Lacado rojo mate. 18 Matt graphite grey / Lacado gris grafito. vibia.com Finish customization at / Personaliza acabado en 	/12. 2700 °K. Dimmable: 0-10V.
	0275 03 /1B. 0275 06 /1B. 0275 18 /1B.	1 x LED 13W 500mA.	LED IP20 CE Bi-volt	<ul style="list-style-type: none"> 03 Matt white lacquer / Lacado blanco mate. 06 Matt red lacquer / Lacado rojo mate. 18 Matt graphite grey / Lacado gris grafito. vibia.com Finish customization at / Personaliza acabado en 	/1B. 2700 °K. Dimmable: 1-10V + Push.
	0280 03 /1B. 0280 06 /1B. 0280 18 /1B.	3 x LED 9W 350mA.	LED IP20 CE Bi-volt		
	0282 03 /1B. 0282 06 /1B. 0282 18 /1B.	5 x LED 9W 350mA.	LED IP20 CE Bi-volt		
Built-in / Empotrado.	0271 03 /1B. 0271 06 /1B. 0271 18 /1B.	1 x LED 9W 350mA.	ϕ 11,5 cm		
Built-in and surface fitting / Permite instalación de empotrar y superficie.	0276 03 /1B. 0276 06 /1B. 0276 18 /1B.	1 x LED 13W 500mA.	ϕ 11,5 cm	LED IP20 CE Bi-volt	

Check additional product specifications at the end of this catalogue: Technical information / Consultar especificaciones adicionales del producto al final del catálogo: Información Técnica.



Pages: A-60. B-142.



0270 06 /12. 0270 18 /12. 0275 03 /1B.

Rhythm Horizontal

Design by Arik Levy.



Endless visions, infinite compositions. Rhythm gives everyone the chance to compose their own score.

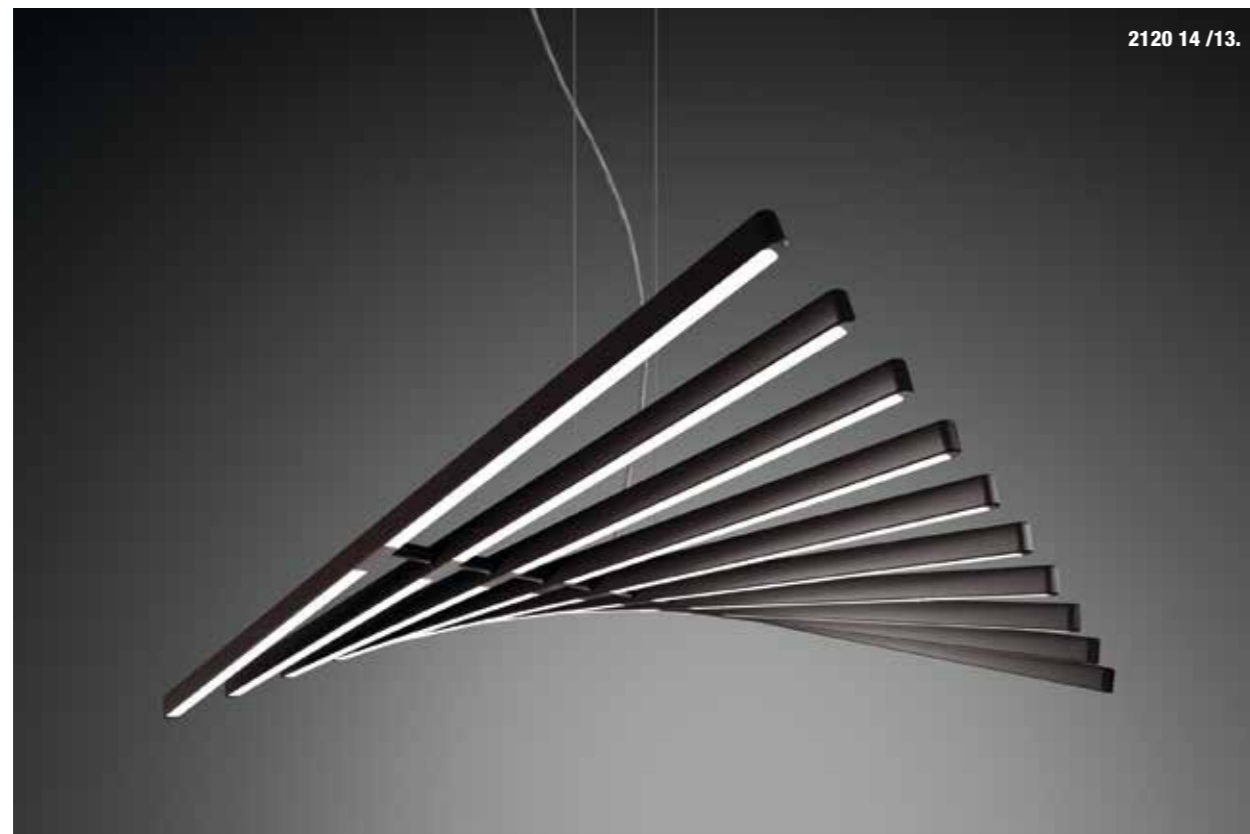

Create your product configuration quickly and easily at vibia.com

Go to vibia.com and discover the quickest, most effective way to configure a unique Rhythm luminaire design.

Crea tu configuración de producto de manera rápida y fácil en vibia.com

Entra en vibia.com y descubre la manera más rápida y eficiente de configurar un diseño único de Rhythm.

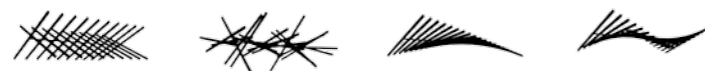

2130 58 /13.



2120 14 /13.

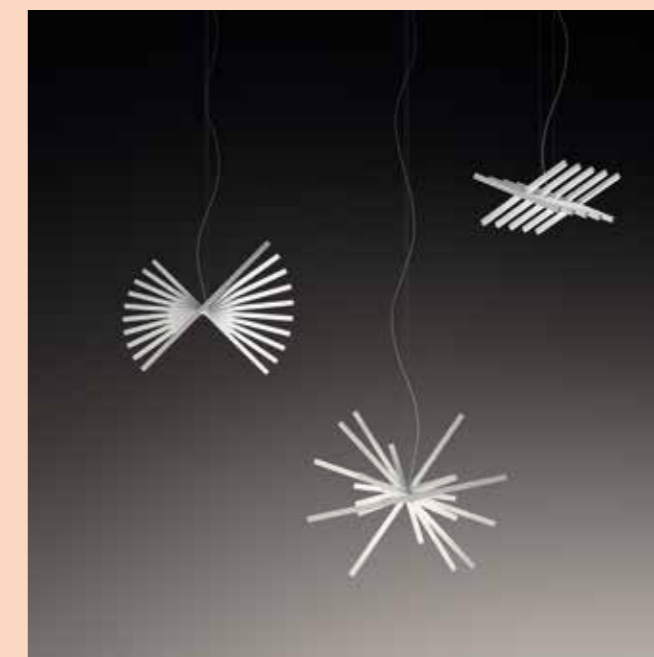

2110 58 /13.
2120 58 /13.
2130 58 /13.



2121 14 /13.



2133 58 /13.

Horizontals Downlighting / Horizontales Luz hacia abajo

Stick 47 cm

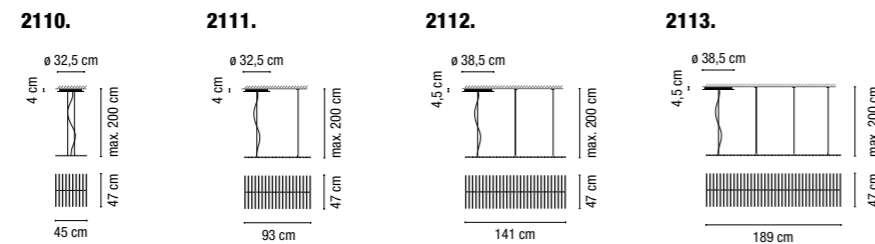

Stick 87 cm

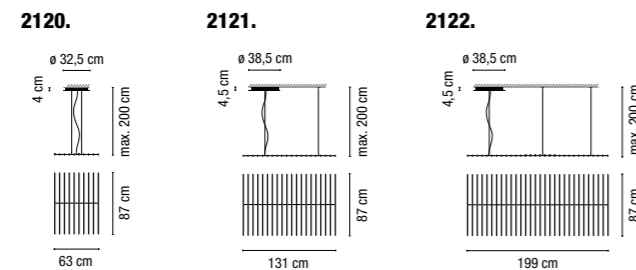

Stick 47/87 cm

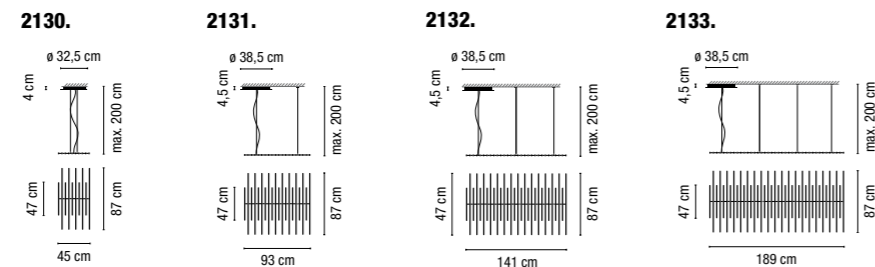

Polycarbonate diffuser / Difusor de policarbonato.



2110 14 /13. 2110 58 /13.	2191 14 (96mm) Built-in accessory chocolate / Kit florón empotrable marrón. 2191 58 (96mm) Built-in accessory off-white matt / Kit florón empotrable blanco.	10 x LED STRIP 30V 2,9W.	<p>● 14 Matt chocolate lacquer / Lacado marrón oscuro mate.</p> <p>● 58 Off-white matt lacquer / Lacado blanco roto mate.</p>	<p>/13. 2700 °K. Dimmable: 1-10V.</p>
2111 14 /13. 2111 58 /13.	2190 14 (44,5mm) Built-in accessory chocolate / Kit florón empotrable marrón. 2190 58 (44,5mm) Built-in accessory off-white matt / Kit florón empotrable blanco.	20 x LED STRIP 30V 2,9W.		
2112 14 /13. 2112 58 /13.	2190 14 (44,5mm) Built-in accessory chocolate / Kit florón empotrable marrón. 2190 58 (44,5mm) Built-in accessory off-white matt / Kit florón empotrable blanco.	30 x LED STRIP 30V 2,9W.		
2113 14 /13. 2113 58 /13.	2190 14 (44,5mm) Built-in accessory chocolate / Kit florón empotrable marrón. 2190 58 (44,5mm) Built-in accessory off-white matt / Kit florón empotrable blanco.	40 x LED STRIP 30V 2,9W.		
2120 14 /13. 2120 58 /13.	2192 14 (136mm) Built-in accessory chocolate / Kit florón empotrable marrón. 2192 58 (136mm) Built-in accessory off-white matt / Kit florón empotrable blanco.	10 x LED STRIP 30V 5,8W.		
2121 14 /13. 2121 58 /13.	2190 14 (44,5mm) Built-in accessory chocolate / Kit florón empotrable marrón. 2190 58 (44,5mm) Built-in accessory off-white matt / Kit florón empotrable blanco.	20 x LED STRIP 30V 5,8W.		
2122 14 /13. 2122 58 /13.	2190 14 (44,5mm) Built-in accessory chocolate / Kit florón empotrable marrón. 2190 58 (44,5mm) Built-in accessory off-white matt / Kit florón empotrable blanco.	30 x LED STRIP 30V 5,8W.		
2130 14 /13. 2130 58 /13.	2191 14 (96mm) Built-in accessory chocolate / Kit florón empotrable marrón. 2191-58 (96mm) Built-in accessory off-white matt / Kit florón empotrable blanco.	5 x LED STRIP 30V 2,9W. 5 x LED STRIP 30V 5,8W.		
2131 14 /13. 2131 58 /13.	2190 14 (44,5mm) Built-in accessory chocolate / Kit florón empotrable marrón. 2190 58 (44,5mm) Built-in accessory off-white matt / Kit florón empotrable blanco.	10 x LED STRIP 30V 2,9W. 10 x LED STRIP 30V 5,8W.		
2132 14 /13. 2132 58 /13.	2190 14 (44,5mm) Built-in accessory chocolate / Kit florón empotrable marrón. 2190 58 (44,5mm) Built-in accessory off-white matt / Kit florón empotrable blanco.	15 x LED STRIP 30V 2,9W. 15 x LED STRIP 30V 5,8W.		
2133 14 /13. 2133 58 /13.	2190 14 (44,5mm) Built-in accessory chocolate / Kit florón empotrable marrón. 2190 58 (44,5mm) Built-in accessory off-white matt / Kit florón empotrable blanco.	20 x LED STRIP 30V 2,9W. 20 x LED STRIP 30V 5,8W.		

The product is delivered flat. The sticks can be positioned as you wish and fixed into position / El producto se entrega plano. Los sticks pueden posicionarse según se desee y fijarse en la posición. Check additional product specifications at the end of this catalogue: Technical information / Consultar especificaciones adicionales del producto al final del catálogo: Información Técnica.



Rhythm Vertical

Design by Arik Levy.



Endless visions, infinite compositions. Rhythm gives everyone the chance to compose their own score.

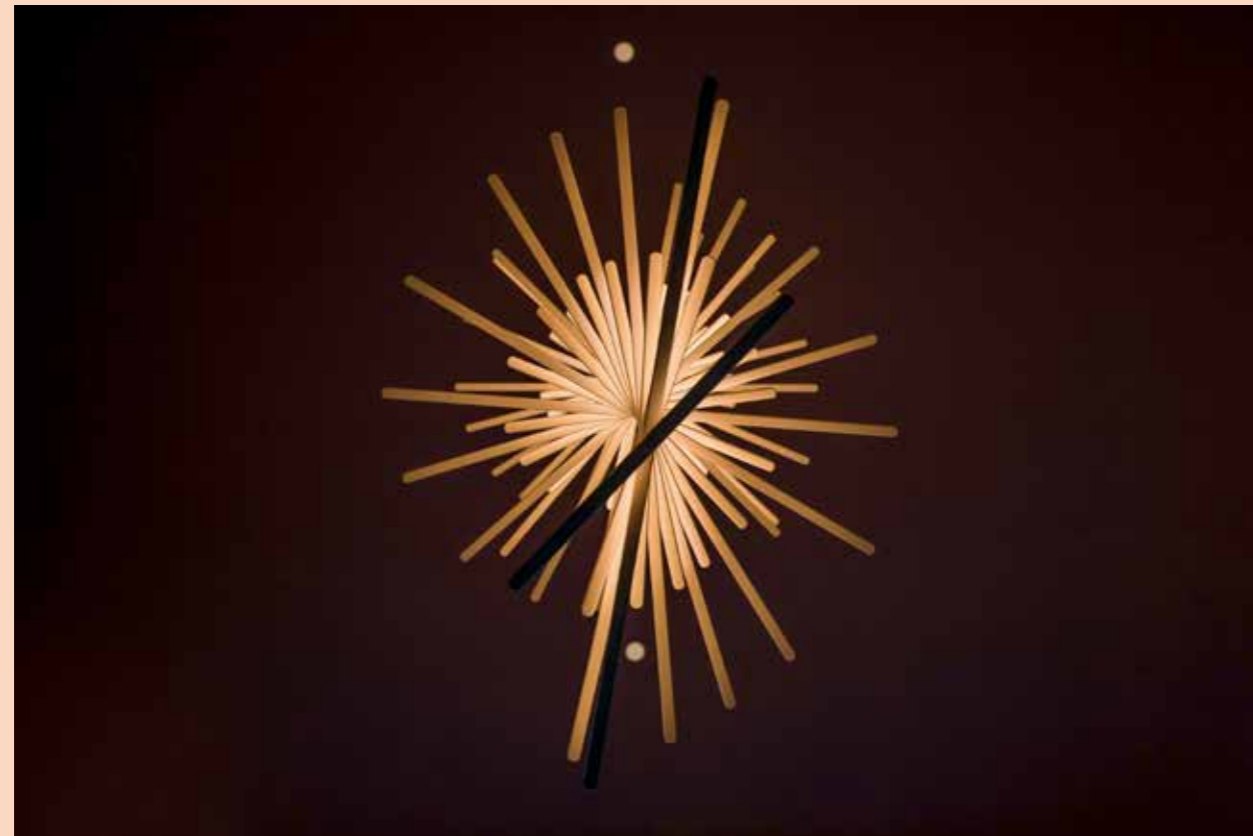

Create your product configuration quickly and easily at vibia.com

Go to vibia.com and discover the quickest, most effective way to configure a unique Rhythm luminaire design.

Crea tu configuración de producto de manera rápida y fácil en vibia.com

Entra en vibia.com y descubre la manera más rápida y eficiente de configurar un diseño único de Rhythm.

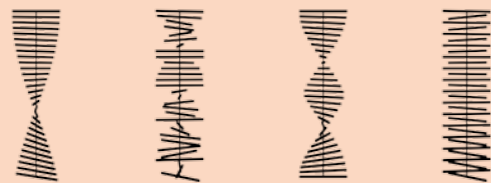

2163 58 /13.



2141 58 /13.



2143 58 /13. 2151 58 /13.

	Verticals Downlighting / Verticales Luz hacia abajo	Verticals Uplighting / Verticales Luz hacia arriba
Stick 47 cm	<p>2170.</p>	<p>2140. 2141. 2142. 2143.</p>
Stick 87 cm	<p>2175.</p>	<p>2150. 2151. 2152.</p>
Stick 47/87 cm	<p>2180.</p>	<p>2160. 2161. 2162. 2163.</p>



Polycarbonate diffuser / Difusor de policarbonato.		LED	IP20	CE	Bi-volt
2140 14 /13. 2140 58 /13.	2191 14 (96mm) Built-in accessory chocolate / Kit florón empotrable marrón. 2191 58 (96mm) Built-in accessory off-white matt / Kit florón empotrable blanco.	10 x LED STRIP 30V 2,9W.	<p>14 Matt chocolate lacquer / Lacado marrón oscuro mate. 58 Off-white matt lacquer / Lacado blanco roto mate.</p>	<p>/13. 2700 °K. Dimmable: 1-10V.</p>	
2170 14 /13. 2170 58 /13.	2192 14 (136mm) Built-in accessory chocolate / Kit florón empotrable marrón. 2192 58 (136mm) Built-in accessory off-white matt / Kit florón empotrable blanco.	20 x LED STRIP 30V 2,9W.			
2141 14 /13. 2141 58 /13.	2191 14 (96mm) Built-in accessory chocolate / Kit florón empotrable marrón. 2191 58 (96mm) Built-in accessory off-white matt / Kit florón empotrable blanco.	30 x LED STRIP 30V 2,9W.			
2142 14 /13. 2142 58 /13.	2191 14 (96mm) Built-in accessory chocolate / Kit florón empotrable marrón. 2191 58 (96mm) Built-in accessory off-white matt / Kit florón empotrable blanco.	40 x LED STRIP 30V 2,9W.			
2143 14 /13. 2143 58 /13.	2191 14 (96mm) Built-in accessory chocolate / Kit florón empotrable marrón. 2191 58 (96mm) Built-in accessory off-white matt / Kit florón empotrable blanco.	10 x LED STRIP 30V 5,8W.			
2150 14 /13. 2150 58 /13.	2191 14 (96mm) Built-in accessory chocolate / Kit florón empotrable marrón. 2191 58 (96mm) Built-in accessory off-white matt / Kit florón empotrable blanco.	20 x LED STRIP 30V 5,8W.			
2175 14 /13. 2175 58 /13.	2192 14 (136mm) Built-in accessory chocolate / Kit florón empotrable marrón. 2192 58 (136mm) Built-in accessory off-white matt / Kit florón empotrable blanco.	30 x LED STRIP 30V 5,8W.			
2151 14 /13. 2151 58 /13.	2191 14 (96mm) Built-in accessory chocolate / Kit florón empotrable marrón. 2191 58 (96mm) Built-in accessory off-white matt / Kit florón empotrable blanco.	5 x LED STRIP 30V 2,9W. 5 x LED STRIP 30V 5,8W.			
2152 14 /13. 2152 58 /13.	2191 14 (96mm) Built-in accessory chocolate / Kit florón empotrable marrón. 2191 58 (96mm) Built-in accessory off-white matt / Kit florón empotrable blanco.	10 x LED STRIP 30V 2,9W. 10 x LED STRIP 30V 5,8W.			
2160 14 /13. 2160 58 /13.	2191 14 (96mm) Built-in accessory chocolate / Kit florón empotrable marrón. 2191 58 (96mm) Built-in accessory off-white matt / Kit florón empotrable blanco.	15 x LED STRIP 30V 2,9W. 15 x LED STRIP 30V 5,8W.			
2180 14 /13. 2180 58 /13.	2192 14 (136mm) Built-in accessory chocolate / Kit florón empotrable marrón. 2192 58 (136mm) Built-in accessory off-white matt / Kit florón empotrable blanco.	20 x LED STRIP 30V 2,9W. 20 x LED STRIP 30V 5,8W.			
2161 14 /13. 2161 58 /13.	2191 14 (96mm) Built-in accessory chocolate / Kit florón empotrable marrón. 2191 58 (96mm) Built-in accessory off-white matt / Kit florón empotrable blanco.				
2162 14 /13. 2162 58 /13.	2191 14 (96mm) Built-in accessory chocolate / Kit florón empotrable marrón. 2191 58 (96mm) Built-in accessory off-white matt / Kit florón empotrable blanco.				
2163 14 /13. 2163 58 /13.	2191 14 (96mm) Built-in accessory chocolate / Kit florón empotrable marrón. 2191 58 (96mm) Built-in accessory off-white matt / Kit florón empotrable blanco.				

The product is delivered flat. The sticks can be positioned as you wish and fixed into position / El producto se entrega plano. Los sticks pueden posicionarse según se desee y fijarse en la posición.
Check additional product specifications at the end of this catalogue: Technical information / Consultar especificaciones adicionales del producto al final del catálogo: Información Técnica.



Mayfair

Design by Diego Fortunato.

The Mayfair light fitting represents an evolution from 18th Century lamps. While also featuring the most advanced lighting technology and retaining its charm and ability to delight.



5525 18 /1B.

5525 20 /1B. 5525 67 /1B. 5525 93 /1B.



Mayfair

5520. 5525.

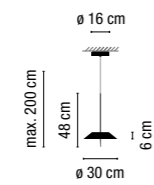



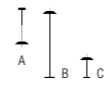
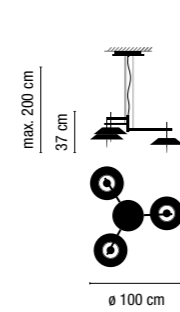























5530. 5535.



Pages: A-74. B-164. C-170.

Polycarbonate diffuser / Difusor de policarbonato.

Methacrylate shade / Pantalla de metacrilato.	5520 07 /1B.	 07 Gloss black nickel and green / Níquel negro brillante y verde.	LED  IP20  	1 x LED STRIP 24V 2,4W.	/1B. 2700 °K. Dimmable: 1-10V + Push.
	5520 08 /1B.	 08 Gloss black nickel and orange / Níquel negro brillante y naranja.		1 x LED STRIP 24V 16,8W.	
	5530 07 /13.	 07 Gloss black nickel and green / Níquel negro brillante y verde.	LED  IP20   	3 x LED STRIP 24V 2,4W.	/13. 2700 °K. Dimmable: 1-10V
	5530 08 /13.	 08 Gloss black nickel and orange / Níquel negro brillante y naranja.		3 x LED STRIP 24V 16,8W.	
Steel shade / Pantalla de acero.	5525 18 /1B.	 18 Matt graphite lacquer / Lacado grafito mate.	LED  IP20  	1 x LED STRIP 24V 2,4W.	/1B. 2700 °K. Dimmable: 1-10V + Push.
	5525 20 /1B.	 20 Matt gold / Oro satinado mate.		1 x LED STRIP 24V 16,8W.	
	5525 67 /1B.	 67 Gloss copper / Cobre brillo.			
	5525 93 /1B.	 93 Matt white lacquer / Lacado blanco mate.			
	5535 18 /13.	 18 Matt graphite lacquer / Lacado grafito mate.	LED  IP20   	3 x LED STRIP 24V 2,4W.	/13. 2700 °K. Dimmable: 1-10V
	5535 20 /13.	 20 Matt gold / Oro satinado mate.		3 x LED STRIP 24V 16,8W.	
	5535 67 /13.	 67 Gloss copper / Cobre brillo.			
	5535 93 /13.	 93 Matt white lacquer / Lacado blanco mate.			

Check additional product specifications at the end of this catalogue: Technical information /
Consultar especificaciones adicionales del producto al final del catálogo: Información Técnica.

5535 93 /13.



5525 18 /1B.

HaloLineal

Design by Martín Azúa.



Halo floats in space composing harmonious and captivating shapes.
Light and matter united as one.

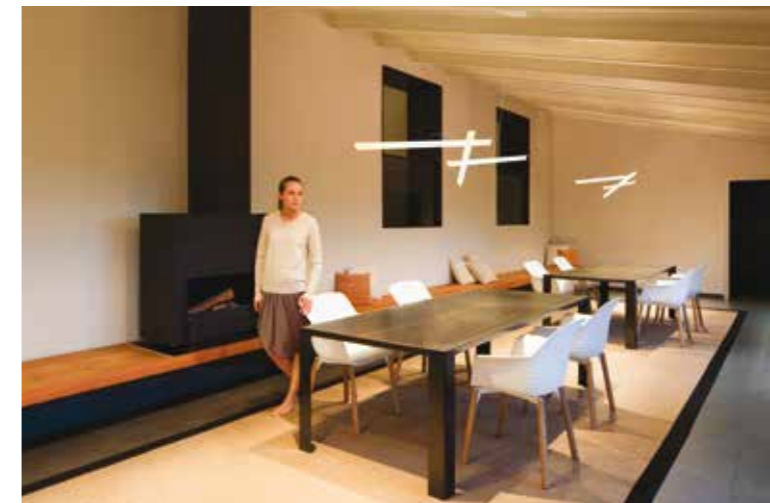
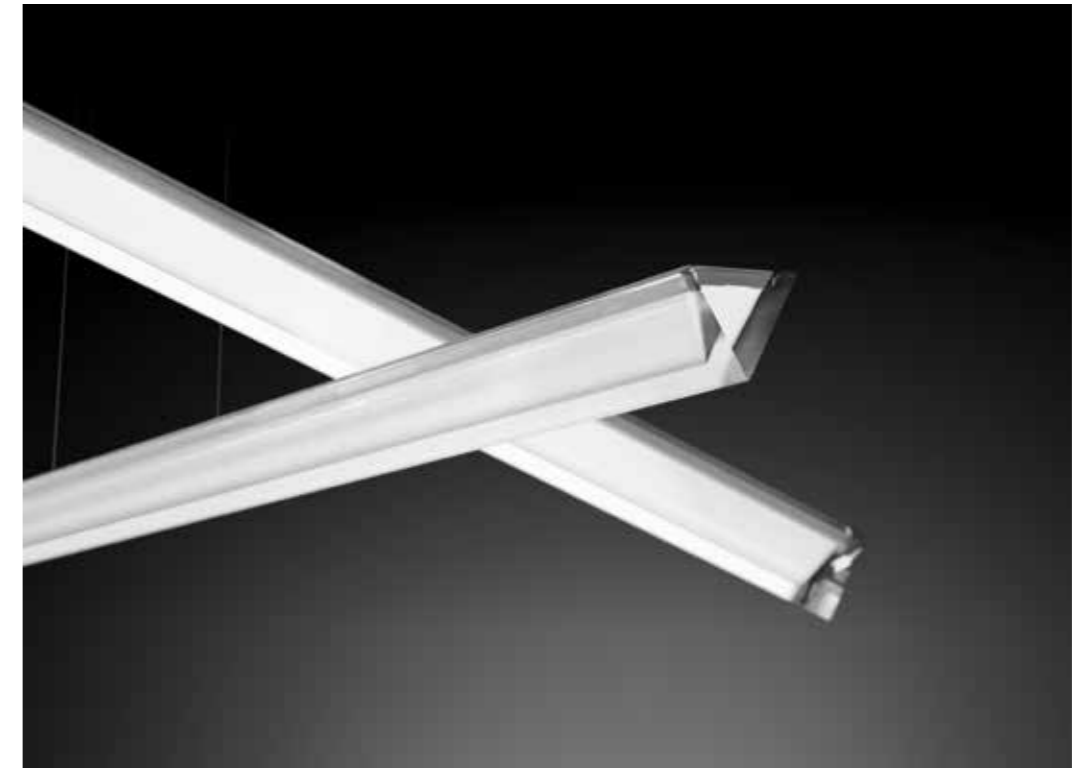

2341 03.



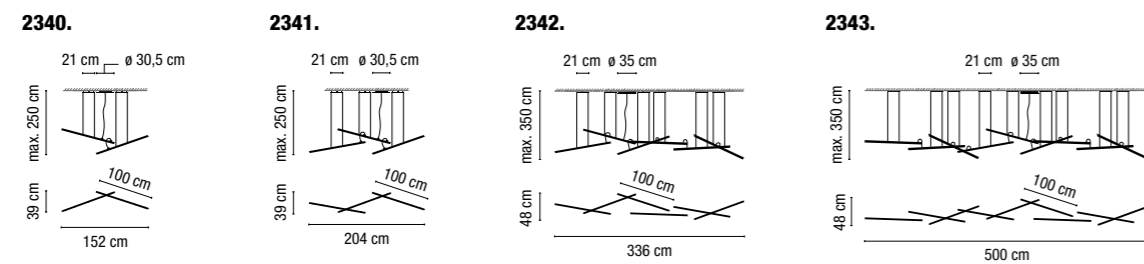

PMMA diffuser / Difusor de PMMA.



2340 03.	2 x LED STRIP 24V 15,8W.	● 03 Matt white lacquer / Lacado blanco mate.
2341 03.	3 x LED STRIP 24V 15,8W.	
2342 03.	6 x LED STRIP 24V 15,8W.	
2343 03.	9 x LED STRIP 24V 15,8W.	

1-10V Electronic dimming / Regulación electrónica 1-10V

Check additional product specifications at the end of this catalogue: Technical information / Consultar especificaciones adicionales del producto al final del catálogo: Información Técnica.

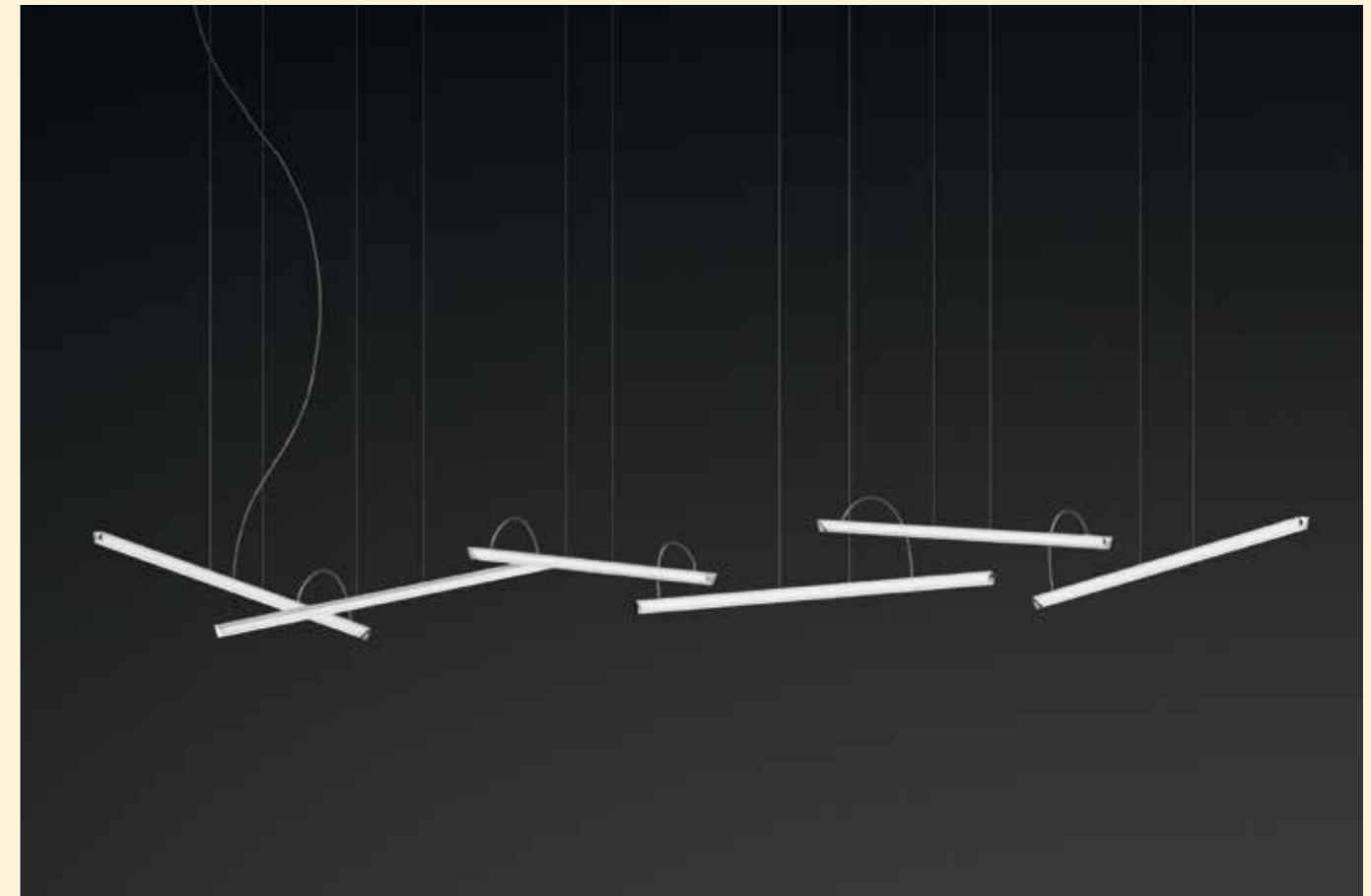

Create your product configuration quickly and easily at vibia.com

Go to vibia.com and discover the quickest, most effective way to configure a unique Halo luminaire design.

Crea tu configuración de producto de manera rápida y fácil en vibia.com

Entra en vibia.com y descubre la manera más rápida y eficiente de configurar un diseño único de Halo.

HaloCircular

Design by Martín Azúa.



Essential light compositions.



2332 03.



2331 03. 2332 03.



Halo Circular

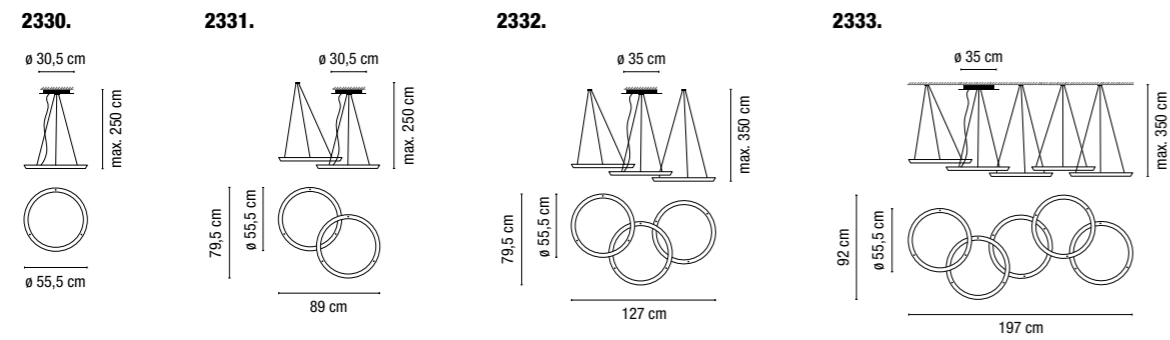

PMMA diffuser / Difusor de PMMA.



2330 03.	1 x LED STRIP 24V 23,7W.
2331 03.	2 x LED STRIP 24V 23,7W.
2332 03.	3 x LED STRIP 24V 23,7W.
2333 03.	5 x LED STRIP 24V 23,7W.

● 03 Matt white lacquer / Lacado blanco mate.

1-10V Electronic dimming / Regulación electrónica 1-10V
Check additional product specifications at the end of this catalogue: Technical information /
Consultar especificaciones adicionales del producto al final del catálogo: Información Técnica.



Create your product configuration quickly and easily at vibia.com

Go to vibia.com and discover the quickest, most effective way to configure a unique Halo luminaire design.

Crea tu configuración de producto de manera rápida y fácil en vibia.com

Entra en vibia.com y descubre la manera más rápida y eficiente de configurar un diseño único de Halo.



North

Design by Arik Levy



North, south, east and west are our points of references in space;
we set-out, build and travel according to these coordinates.



5670 04 /1B.



5670 04 /1B. 5674 04 /1B.

North

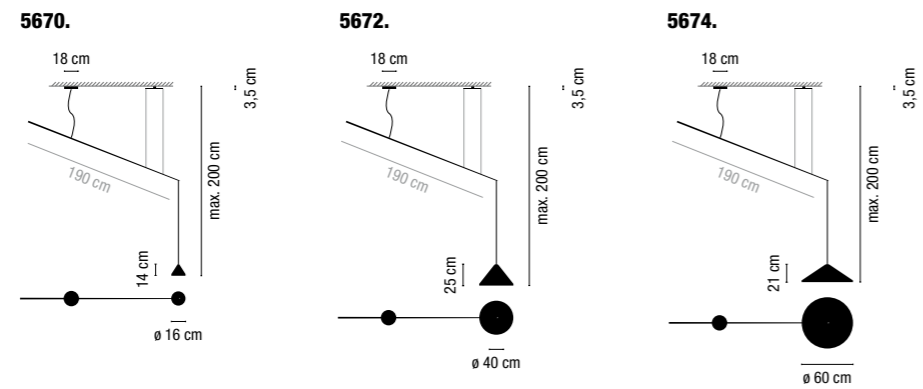
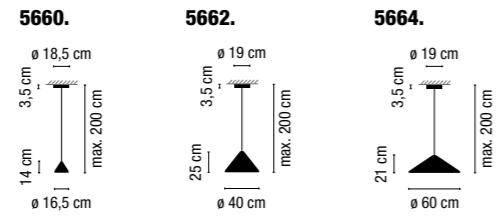

Aluminum shade / Pantalla de aluminio.

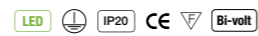

5660 04 /1B. 5660 58 /1B. 5660 05 /1B. 5660 93 /1B.

5662 04 /1B. 5662 58 /1B. 5662 05 /1B. 5662 93 /1B.

5664 04 /1B. 5664 58 /1B. 5664 05 /1B. 5664 93 /1B.

5670 04 /1B. 5670 58 /1B. 5670 05 /1B. 5670 93 /1B.

5672 04 /1B. 5672 58 /1B. 5672 05 /1B. 5672 93 /1B.

5674 04 /1B. 5674 58 /1B. 5674 05 /1B. 5674 93 /1B.

1 x LED 9W 350mA.

- 04 Matt graphite lacquer / Lacado grafito mate.
- 05 Matt blue lacquer / Lacado azul mate.
- 58 Matt cream lacquer / Lacado crema mate.
- 93 Matt white lacquer / Lacado blanco mate.

/1B.
2700 °K.
Dimmable: 1-10V + Push.

Check additional product specifications at the end of this catalogue: Technical information / Consultar especificaciones adicionales del producto al final del catálogo: Información Técnica.

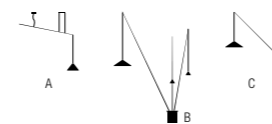

Pages: A-86. B-136. C-272.



Height-adjustable shade / Pantalla ajustable en altura.



5660 93 /1B.
5662 93 /1B.

Vol

Design by Lievore, Altherr, Molina.



Warm volumes that provide the foundation for creating highly personal atmospheres.





0220 03.



0220 03. 0225 03.



0225 03.

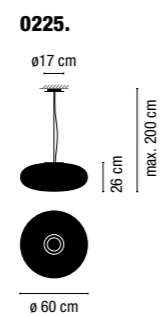
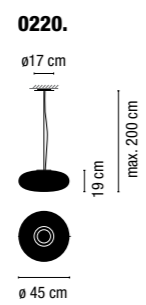

Matt opal diffuser triplex blown-glass diffuser / Difusor de vidrio soplado opal mate triplex.



0220 03. 4 x Core Pro LEDbulb E27 230V 9W.

0225 03. OR 4 x COMPACT FLUORESCENT E27 230V 16W Max. (Philips Softone-Doble Envelope)

● 03 Matt white lacquer / Lacado blanco mate.

Check additional product specifications at the end of this catalogue: Technical information / Consultar especificaciones adicionales del producto al final del catálogo: Información Técnica.

Warm

Design by Ramos & Bassols



Home sweet home.



4935 58.

94



4926 14. 4926 06. 4926 58.

95

Pendants / Colgantes

Warm

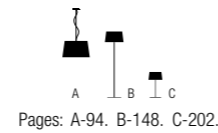
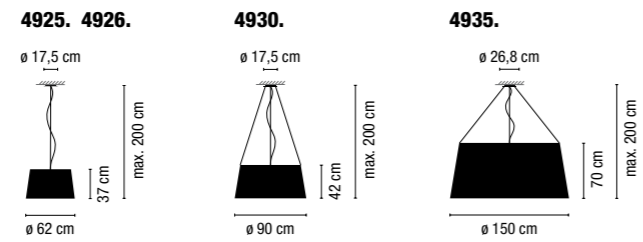

Pages: A-94. B-148. C-202.

Methacrylate diffuser / Difusor de metacrilato.



Screen shade / Pantalla screen.	4925 58.	<ul style="list-style-type: none"> 4 x MASTER LEDBulb E27 230V 13W. OR 4 x COMPACT FLUORESCENT E27 230V 20W Max. (Philips Softone-Doble Envelope) 	<ul style="list-style-type: none"> 58 Off-white matt lacquer / Lacado blanco roto mate.
	4930 58.	<ul style="list-style-type: none"> 4 x MASTER LEDBulb E27 230V 13W. OR 4 x COMPACT FLUORESCENT E27 230V 23W Max. 	
	4935 58.	<ul style="list-style-type: none"> 5 x MASTER LEDBulb E27 230V 13W. OR 5 x COMPACT FLUORESCENT E27 230V 30W Max. 	
Aluminum shade / Pantalla de aluminio.	<ul style="list-style-type: none"> 4926 06. 4926 14. 4926 58. 	<ul style="list-style-type: none"> 4 x MASTER LEDBulb E27 230V 13W. OR 4 x COMPACT FLUORESCENT E27 230V 20W Max. 	<ul style="list-style-type: none"> 06 Matt red lacquer / Lacado rojo mate. 14 Matt chocolate lacquer / Lacado marrón oscuro mate. 58 Off-white matt lacquer / Lacado blanco roto mate. <p>vibia.com Finish customization at / Personaliza acabado en</p>

Check additional product specifications at the end of this catalogue: Technical information / Consultar especificaciones adicionales del producto al final del catálogo: Información Técnica.



4930 58.

Ameba

Design by Pete Sans



Free form compositions, infinite creations.

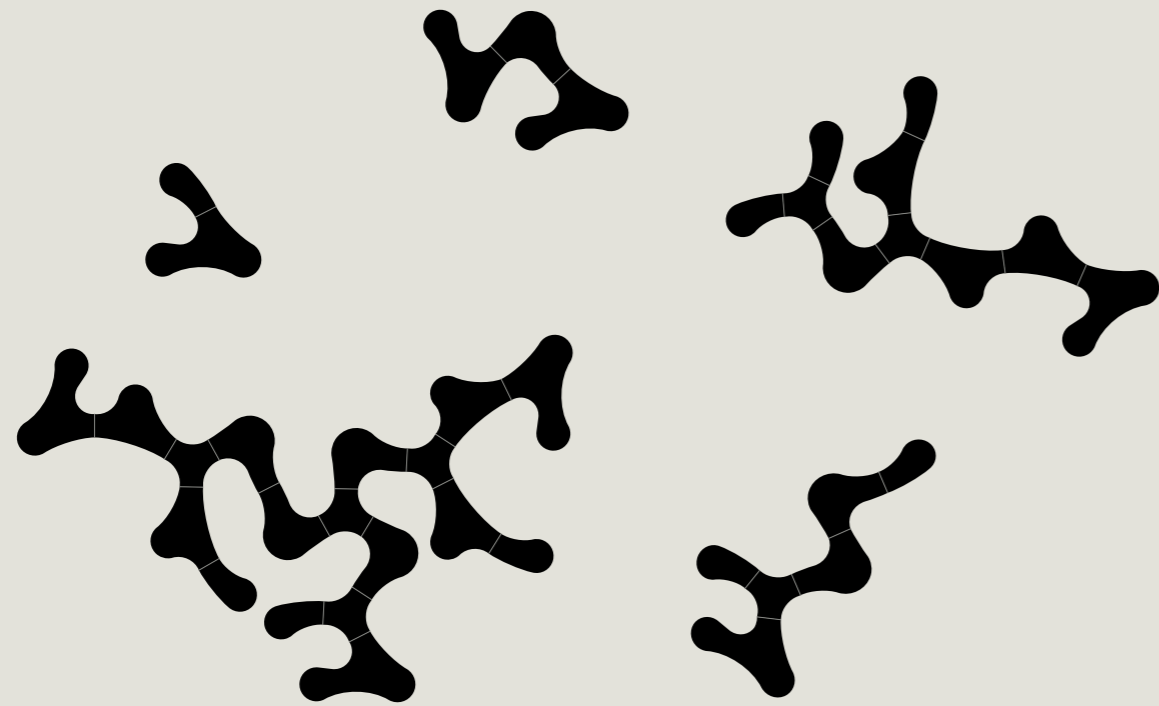

Create your product configuration quickly and easily at vibia.com

Go to vibia.com and discover the quickest, most effective way to configure a unique Ameba luminaire design.

Crea tu configuración de producto de manera rápida y fácil en vibia.com

Entra en vibia.com y descubre la manera más rápida y eficiente de configurar un diseño único de Ameba.

Ameba

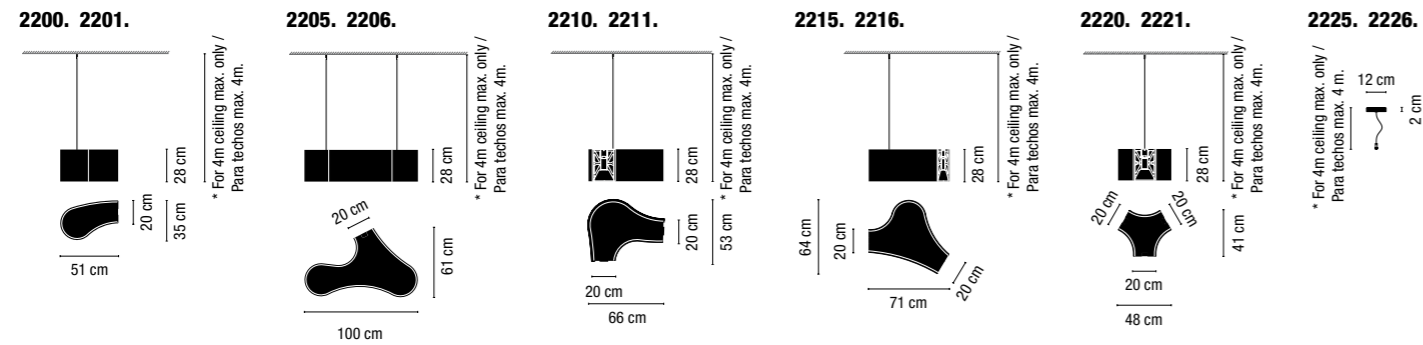

Methacrylate diffuser / Difusor de metacrilato.

	2200 03. 2200 18.	2 x MASTER LEDBulb E27 230V 13W. OR 2 x COMPACT FLUORESCENT E27 230V 15W Max.		<ul style="list-style-type: none"> 03 Matt white lacquer / Lacado blanco mate. 18 Matt graphite lacquer / Lacado grafito mate.
	2205 03. 2210 03. 2215 03. 2205 18. 2210 18. 2215 18.	3 x MASTER LEDBulb E27 230V 13W. OR 3 x COMPACT FLUORESCENT E27 230V 15W Max.		
	2220 03. 2220 18.	1 x MASTER LEDBulb E27 230V 13W. OR 1 x COMPACT FLUORESCENT E27 230V 23W Max.		
	2225 03. 2225 18.	Chrome canopy / Florón cromo.		
Dimmable version: electronic ballast (DALI System / dimmer switch) / Versión regulable: reactancia electrónica (Sistema DALI / pulsador).	2201 03. 2201 18.	2 x COMPACT FLUORESCENT GX24q-2 230V 18W Max.		
	2206 03. 2211 03. 2216 03. 2206 18. 2211 18. 2216 18.	3 x COMPACT FLUORESCENT GX24q-2 230V 18W Max.		
	2221 03. 2221 18.	1 x COMPACT FLUORESCENT GX24q-3 230V 26W Max.		
	2226 03. 2226 18.	Chrome canopy / Florón cromo.		

* For ceiling over 4 metres, ask for custom cable length / Solicitar cable especial para instalaciones en techos superiores a 4 m.
 Check additional product specifications at the end of this catalogue: Technical information /
 Consultar especificaciones adicionales del producto al final del catálogo: Información Técnica.



AmebaSingle

Design by Pete Sans



2230.

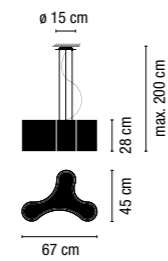

Methacrylate diffuser / Difusor de metacrilato.



2230 03. 3 x MASTER LEDBulb E27 230V 13W.

2230 18. 3 x COMPACT FLUORESCENT E27 230V 15W Max.

03 Matt white lacquer / Lacado blanco mate.

18 Matt graphite lacquer / Lacado grafito mate.

Check additional product specifications at the end of this catalogue: Technical information /
Consultar especificaciones adicionales del producto al final del catálogo: Información Técnica.



Top and bottom methacrylate diffuser.
Chrome canopy /
Difusor superior e inferior de metacrilato.
Florón cromo.

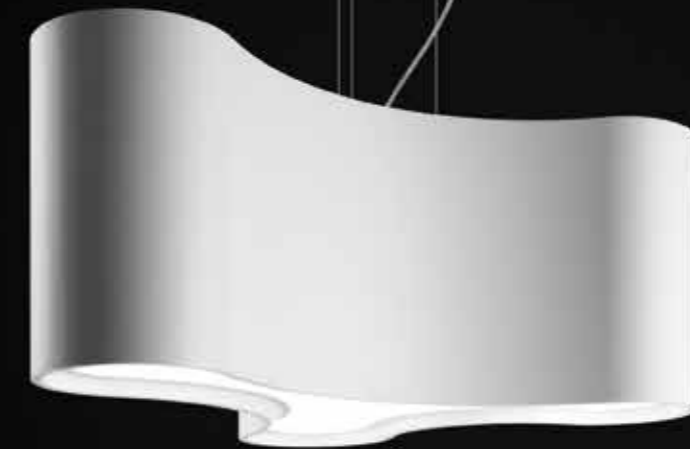

2230 03. 2230 18.

Big

Design by Lievore, Altherr, Molina.



Big breaks new ground in terms of scale and technology, revolutionising the hanging light fitting.

0357 93 /2B.



0535. 0537.

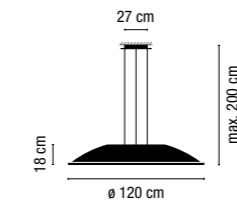

0536. 0538.

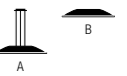
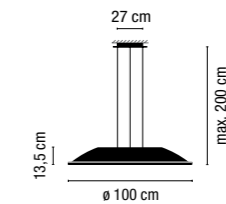

Pages: A-104. B-230/234.

Methacrylate diffuser / Difusor de metacrilato.



Dimmable electronic ballast (DALI System / Dimmer switch) / Reactancia electrónica regulable (Sistema DALI / pulsador).

0535 01. 0536 01.
0535 93. 0536 93.

2 x 2G11 230V 36W.
2 x 2G11 230V 24W.

01 Chrome / Cromo.
93 Matt white lacquer / Lacado blanco mate.

0537 01 /2B. 0538 01 /2B.
0537 01 /4B. 0538 01 /4B.
0537 93 /2B. 0538 93 /2B.
0537 93 /4B. 0538 93 /4B.

4 x LED QUADRANT 16,9W 400mA.

01 Chrome / Cromo.
93 Matt white lacquer / Lacado blanco mate.

/2B.
3000 °K.
Dimmable:
1-10V + Push.
/4B.
4000 °K.
Dimmable:
1-10V + Push.

Check additional product specifications at the end of this catalogue: Technical information / Consultar especificaciones adicionales del producto al final del catálogo: Información Técnica.



Easy-to-install and replace bulb system / Sistema de fácil instalación y sustitución de bombillas.

Jazz

Design by Diego Fortunato.



Sculptural design with a marked sensual but strong character.
Ancestral forms converted into modern design icons.

1336.

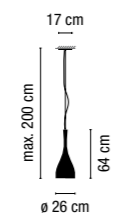

1338.

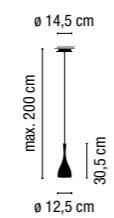

Pages: A-106. B-156. C-192.

Glass diffuser / Difusor de vidrio.



	<p>1336 03. 1336 04. 1336 06. 1336 59. 1336 93.</p> <p>1 x LEDSpot PAR30S E27 230V 9,5W. OR 1 x COMPACT FLUORESCENT E27 230V 30W Max. OR 1 x PAR 30 E27 230V 100W Max.</p>	<p>03 Gloss white lacquer / Lacado blanco brillo. 04 Gloss black lacquer / Lacado negro brillo. 06 Gloss red lacquer / Lacado rojo brillo. 59 Matt mink lacquer / Lacado visón mate. 93 Matt white lacquer / Lacado blanco mate.</p> <p> vibia.com Finish customization at / Personaliza acabado en</p>
Mini	<p>1338 03. 1338 04. 1338 06. 1338 59. 1338 93.</p> <p>1 x LEDSpot PAR30S E27 230V 9,5W. OR 1 x COMPACT FLUORESCENT E27 230V 15W Max. OR 1 x PAR 30 E27 230V 100W Max.</p>	

Check additional product specifications at the end of this catalogue: Technical information /
Consultar especificaciones adicionales del producto al final del catálogo: Información Técnica.



Slim

Design by Jordi Vilardell.



Elegant and magical, like drops of light falling from the sky.
Slim is subtle and ingenious.



0920 03 /1B. 0920 04 /1B.



0925 04 / 1B.



Slim



0914 03 /1B.



0925 04 /1B.













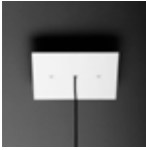











0937 03 /1A.



0940 04 /1B.

Pressed glass diffuser / Difusor de vidrio prensado.



 <p>Surface / Superficie.</p>	0914 03 /1B. 0916 03 /1B. 0914 04 /1B. 0916 04 /1B.	 7 x LED 2,1W 700mA.	<ul style="list-style-type: none">  03 White lacquer fiber / Fibra lacada blanca.  04 Black carbon fiber / Fibra de carbón negro.  vibia.com Finish customization at / Personaliza acabado en 	/1B. 2700 °K. Dimmable: 1-10V + Push.
	0915 03 /1B. 0917 03 /1B. 0915 04 /1B. 0917 04 /1B.	 4 x LED 2,1W 700mA.		
	0920 03 /1B. 0920 04 /1B.	 1 x LED 2,1W 700mA.		
 <p>Built-in / Empotrado.</p>	0925 03 /1B. 0925 04 /1B.	 1 x LED 2,1W 700mA.	<ul style="list-style-type: none">  03 White lacquer fiber / Fibra lacada blanca.  04 Black carbon fiber / Fibra de carbón negro.  vibia.com Finish customization at / Personaliza acabado en 	/1A. 2700 °K. Dimmable: DALI + 1-10V + Push.
 <p>Surface / Superficie.</p>	0931 03 /1B. 0931 04 /1B.	 4 x LED 2,1W 700mA.		
	0933 03 /1B. 0933 04 /1B.	 6 x LED 2,1W 700mA.		
	0935 03 /1B. 0935 04 /1B.	 10 x LED 1W 350mA.		
 <p>Surface / Superficie.</p>	0937 03 /1A. 0937 04 /1A.	 13 x LED 2,1W 700mA.	<ul style="list-style-type: none">  03 White lacquer fiber / Fibra lacada blanca.  04 Black carbon fiber / Fibra de carbón negro.  vibia.com Finish customization at / Personaliza acabado en 	/1B. 2700 °K. Dimmable: 1-10V + Push.
	0940 03 /1B. 0940 04 /1B.	 22 x LED 1W 350mA.		

Check additional product specifications at the end of this catalogue: Technical information / Consultar especificaciones adicionales del producto al final del catálogo: Información Técnica.

Surface / Superficie.

Built-in / Empotrado.

Surface / Superficie.

0920.

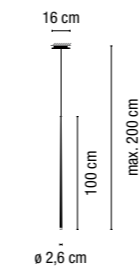

0925.

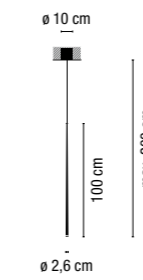

0931.

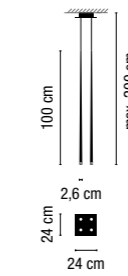

0933.

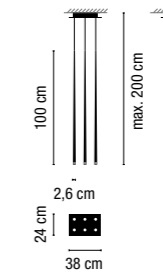

0937.

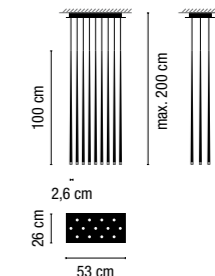

Surface / Superficie.

0914.

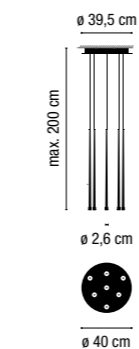

0915.

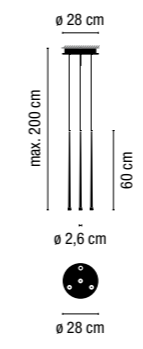

0916.

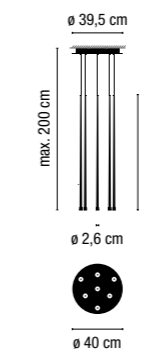

0917.

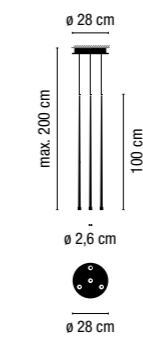

0935.

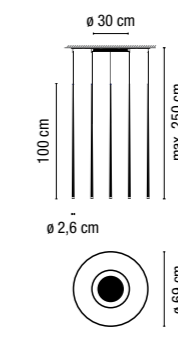

0940.

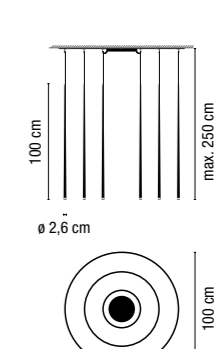

Wind

Design by Jordi Vilardell.



A fresh and contemporary take on the traditional design of lamp shades featuring a groundbreaking manufacturing process.



4070 08. 4076 03. 4075 07.



4076 03.

Wind

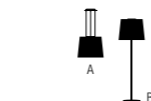
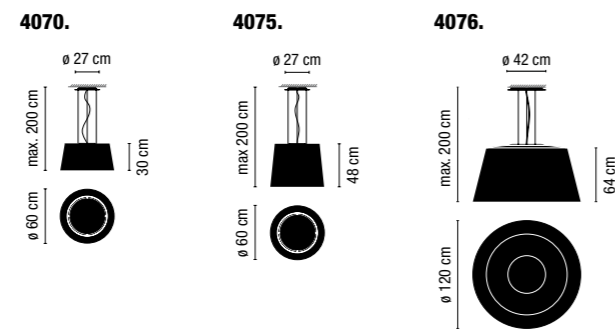

Pages: A-114 / 376. B-376.

Methacrylate diffuser / Difusor de metacrilato.

<p>4070 03. 4075 03. 4070 04. 4075 04. 4070 07. 4075 07. 4070 08. 4075 08.</p>	<p>○ 1 x 2GX13 230V 40W (T5C).</p>	<p>⊕ IP65 CE ▽</p>	<ul style="list-style-type: none"> ○ 03 White fiberglass / Fibra de vidrio blanca. ● 04 Black fiberglass / Fibra de vidrio negro. ● 07 Green fiberglass / Fibra de vidrio verde. ● 08 Orange fiberglass / Fibra de vidrio naranja.
<p>4076 03. 4076 07. 4076 08.</p>	<p>○ 1 x 2GX13 230V 60W (T5C).</p>	<p>⊕ IP20 CE ▽</p>	<ul style="list-style-type: none"> ○ 03 White fiberglass / Fibra de vidrio blanca. ● 07 Green fiberglass / Fibra de vidrio verde. ● 08 Orange fiberglass / Fibra de vidrio naranja.

Check additional product specifications at the end of this catalogue: Technical information /
 Consultar especificaciones adicionales del producto al final del catálogo: Información Técnica.

Curtain

Design by Arik Levy.



It converts the intangible into a presence, the opaque to translucent
and the mundane to something special and mysterious.
And in so doing creates intimacy.



7170 93 /1B. 7160 93 /1B. 7150 93 /1B. 7140 93 /1B. 7150 93 /1B. 7160 93 /1B. 7170 93 /1B.



7161 18 /1B. 7181 18 /1B. 7191 18 /1B. 7191 18 /1B. 7201 18 /1B.



7280 93 /1B. 7250 93 /1B.

Curtain

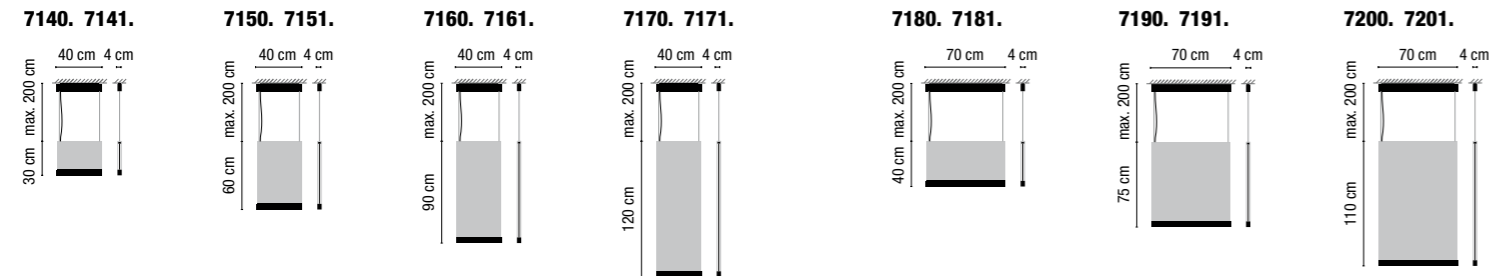

Polycarbonate diffuser / Difusor de policarbonato.



<p>White screen / Screen blanco. 7140 18 /1B. 7160 18 /1B. 7140 93 /1B. 7160 93 /1B. 7150 18 /1B. 7170 18 /1B. 7150 93 /1B. 7170 93 /1B.</p>	<p>●● 18 White screen and graphite profile matt lacquer / Screen blanco y perfil lacado grafito mate. ●● 93 White screen and white profile matt lacquer / Screen blanco y perfil lacado blanco mate.</p>	<p>----- 2 x LED STRIP 8,4W 700mA.</p>	<p>/1B. 2700 °K. Dimmable: 1-10V + Push.</p>
<p>Mink screen / Screen visón. 7141 18 /1B. 7161 18 /1B. 7141 93 /1B. 7161 93 /1B. 7151 18 /1B. 7171 18 /1B. 7151 93 /1B. 7171 93 /1B.</p>	<p>●● 18 Mink screen and graphite profile matt lacquer / Screen visón y perfil lacado grafito mate. ●● 93 Mink screen and white profile matt lacquer / Screen visón y perfil lacado blanco mate.</p>	<p>----- 2 x LED STRIP 8,4W 700mA.</p>	
<p>White screen / Screen blanco. 7180 18 /1B. 7200 18 /1B. 7180 93 /1B. 7200 93 /1B. 7190 18 /1B. 7190 93 /1B.</p>	<p>●● 18 White screen and graphite profile matt lacquer / Screen blanco y perfil lacado grafito mate. ●● 93 White screen and white profile matt lacquer / Screen blanco y perfil lacado blanco mate.</p>	<p>----- 2 x LED STRIP 6,3W 700mA.</p>	
<p>Mink screen / Screen visón. 7181 18 /1B. 7201 18 /1B. 7181 93 /1B. 7201 93 /1B. 7191 18 /1B. 7191 93 /1B.</p>	<p>●● 18 Mink screen and graphite profile matt lacquer / Screen visón y perfil lacado grafito mate. ●● 93 Mink screen and white profile matt lacquer / Screen visón y perfil lacado blanco mate.</p>	<p>----- 2 x LED STRIP 8,4W 700mA.</p>	

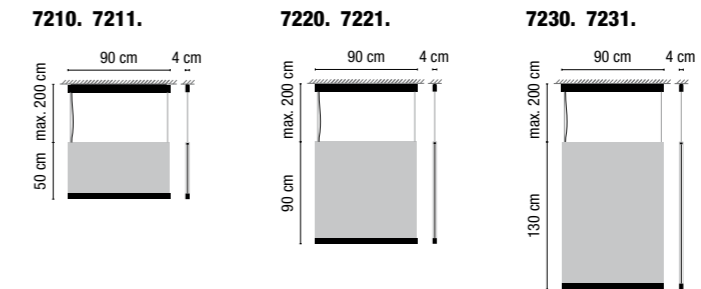

Polycarbonate diffuser / Difusor de policarbonato.



<p>White screen / Screen blanco. 7210 18 /1B. 7230 18 /1B. 7210 93 /1B. 7230 93 /1B. 7220 18 /1B. 7220 93 /1B.</p>	<p>●● 18 White screen and graphite profile matt lacquer / Screen blanco y perfil lacado grafito mate. ●● 93 White screen and white profile matt lacquer / Screen blanco y perfil lacado blanco mate.</p>	<p>----- 6 x LED STRIP 6,3W 700mA.</p>	<p>/1B. 2700 °K. Dimmable: 1-10V + Push.</p>
<p>Mink screen / Screen visón. 7211 18 /1B. 7231 18 /1B. 7211 93 /1B. 7231 93 /1B. 7221 18 /1B. 7221 93 /1B.</p>	<p>●● 18 Mink screen and graphite profile matt lacquer / Screen visón y perfil lacado grafito mate. ●● 93 Mink screen and white profile matt lacquer / Screen visón y perfil lacado blanco mate.</p>		

Check additional product specifications at the end of this catalogue: Technical information / Consultar especificaciones adicionales del producto al final del catálogo: Información Técnica.



7221 93 /1B. 7171 93 /1B.



7170 18 /1B. 7140 18 /1B.
7160 18 /1B. 7150 18 /1B.

Curtain

7250. 7251.

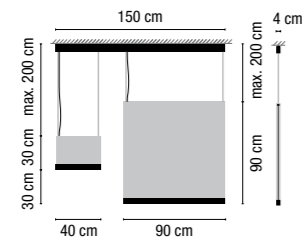

7260. 7261.

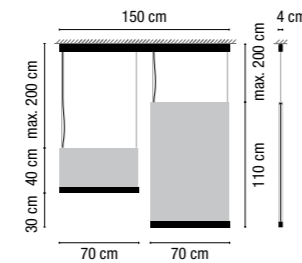

7280. 7281.

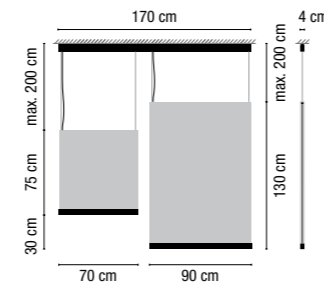

7270. 7271.

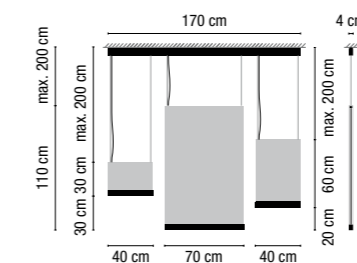

7290. 7291.

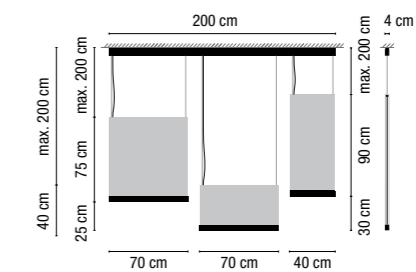

Polycarbonate diffuser / Difusor de policarbonato.



White screen / Screen blanco. 7250 18 /1B. 7250 93 /1B.	<ul style="list-style-type: none"> 18 White screen and graphite profile matt lacquer / Screen blanco y perfil lacado grafito mate. 93 White screen and white profile matt lacquer / Screen blanco y perfil lacado blanco mate. 	<ul style="list-style-type: none"> 6 x LED STRIP 6,3W 700mA. 2 x LED STRIP 8,4W 700mA. 	<ul style="list-style-type: none"> /1B. 2700 °K. Dimmable: 1-10V + Push.
Mink screen / Screen visón. 7251 18 /1B. 7251 93 /1B.	<ul style="list-style-type: none"> 18 Mink screen and graphite profile matt lacquer / Screen visón y perfil lacado grafito mate. 93 Mink screen and white profile matt lacquer / Screen visón y perfil lacado blanco mate. 		
White screen / Screen blanco. 7260 18 /1B. 7260 93 /1B.	<ul style="list-style-type: none"> 18 White screen and graphite profile matt lacquer / Screen blanco y perfil lacado grafito mate. 93 White screen and white profile matt lacquer / Screen blanco y perfil lacado blanco mate. 	<ul style="list-style-type: none"> 4 x LED STRIP 6,3W 700mA. 4 x LED STRIP 8,4W 700mA. 	<ul style="list-style-type: none"> /1B. 2700 °K. Dimmable: 1-10V + Push.
Mink screen / Screen visón. 7261 18 /1B. 7261 93 /1B.	<ul style="list-style-type: none"> 18 Mink screen and graphite profile matt lacquer / Screen visón y perfil lacado grafito mate. 93 Mink screen and white profile matt lacquer / Screen visón y perfil lacado blanco mate. 		
White screen / Screen blanco. 7280 18 /1B. 7280 93 /1B.	<ul style="list-style-type: none"> 18 White screen and graphite profile matt lacquer / Screen blanco y perfil lacado grafito mate. 93 White screen and white profile matt lacquer / Screen blanco y perfil lacado blanco mate. 	<ul style="list-style-type: none"> 8 x LED STRIP 6,3W 700mA. 2 x LED STRIP 8,4W 700mA. 	<ul style="list-style-type: none"> /1B. 2700 °K. Dimmable: 1-10V + Push.
Mink screen / Screen visón. 7281 18 /1B. 7281 93 /1B.	<ul style="list-style-type: none"> 18 Mink screen and graphite profile matt lacquer / Screen visón y perfil lacado grafito mate. 93 Mink screen and white profile matt lacquer / Screen visón y perfil lacado blanco mate. 		

White screen / Screen blanco.
7270 18 /1B.
7270 93 /1B.

- 18 White screen and graphite profile matt lacquer / Screen blanco y perfil lacado grafito mate.
- 93 White screen and white profile matt lacquer / Screen blanco y perfil lacado blanco mate.

- 2 x LED STRIP 6,3W 700mA.
- 6 x LED STRIP 8,4W 700mA.

- /1B. 2700 °K.
- Dimmable: 1-10V + Push.

Mink screen / Screen visón.
7271 18 /1B.
7271 93 /1B.

- 18 Mink screen and graphite profile matt lacquer / Screen visón y perfil lacado grafito mate.
- 93 Mink screen and white profile matt lacquer / Screen visón y perfil lacado blanco mate.

White screen / Screen blanco.
7290 18 /1B.
7290 93 /1B.

- 18 White screen and graphite profile matt lacquer / Screen blanco y perfil lacado grafito mate.
- 93 White screen and white profile matt lacquer / Screen blanco y perfil lacado blanco mate.

- 4 x LED STRIP 6,3W 700mA.
- 6 x LED STRIP 8,4W 700mA.

- /1B. 2700 °K.
- Dimmable: 1-10V + Push.

Check additional product specifications at the end of this catalogue: Technical information / Consultar especificaciones adicionales del producto al final del catálogo: Información Técnica.

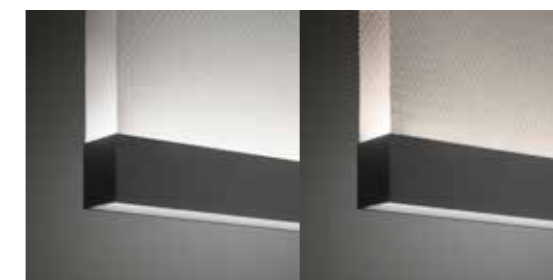

White screen and graphite profile matt lacquer / Screen blanco y perfil lacado grafito mate.

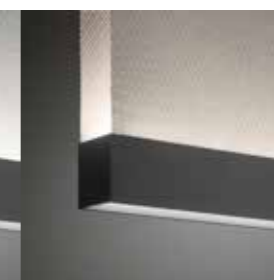

Mink screen and graphite profile matt lacquer / Screen visón y perfil lacado grafito mate.



White screen and white profile matt lacquer / Screen blanco y perfil lacado blanco mate.



Mink screen and white profile matt lacquer / Screen visón y perfil lacado blanco mate.

Floor

Delicate Gesture,
Furniture Meets Light,
My Refuge...



Delicate Gesture

Delicacy and subtly can be distinguished in an attitude towards design, through the elegance of a gesture, a lighting effect or the transparency of a shadow.

Furniture Meets Light

Elements of furniture items that integrate light, thus creating a new product category. The designs adapt to their double function and encourage an interaction with users.



My Refuge

An evolution of the most universal concepts, those which have survived the natural selection process and remain with us. Products designed to improve the intimate spaces we inhabit and to update tradition within interior design.



Floor



Balance
pag. 160



I. Cono
pag. 146



Jazz
pag. 156



Mayfair
pag. 164



North
pag. 136



Pin
pag. 128



Skan
pag. 142



Suite
pag. 132



Swing
pag. 152



Warm
pag. 148



Pin

Design by Ichiro Iwasaki



Through the exploration of "eternal comfort" in lighting environments PIN aims to provide something new and original yet in harmony with both the old and the contemporary.



1660 04 /10. 1670 04 /10.



1660 04 /10. 1660 62 /10. 1660 58 /10. 1660 93 /10.

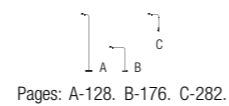
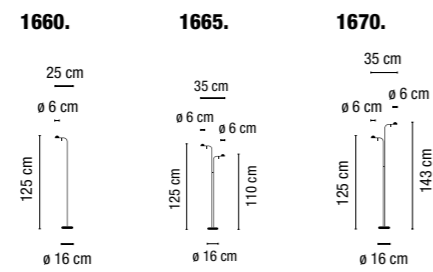

Pages: A-128. B-176. C-282.

Polycarbonate diffuser / Difusor de policarbonato.

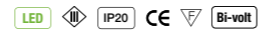

<p>1660 04 /10. 1660 58 /10. 1660 62 /10. 1660 93 /10.</p>	<p>1 x LED 4,5W 350mA.</p>	<ul style="list-style-type: none"> ● 04 Matt black lacquer / Lacado negro mate. ● 58 Matt cream lacquer / Lacado crema mate. ● 62 Matt green lacquer / Lacado verde mate. ● 93 Matt white lacquer / Lacado blanco mate. 	<p>/10. 2700 °K. Dimmable: No.</p>
<p>1665 04 /10. 1670 04 /10. 1665 58 /10. 1670 58 /10. 1665 62 /10. 1670 62 /10. 1665 93 /10. 1670 93 /10.</p>	<p>2 x LED 4,5W 350mA.</p>		

Check additional product specifications at the end of this catalogue: Technical information / Consultar especificaciones adicionales del producto al final del catálogo: Información Técnica.



1660 04 /10.

Suite

Design by Jordi Vilardell & Merixell Vidal.



Reinterprets and updates the traditional combination of side table or shelf with table lamp. Its warm and comfortable lighting effect appears when least expected, a pleasant luminous surprise.



6006 14 /15. 6012 93 /15. 6005 93 /10.

Reading light matt mink lacquer /
Luz de lectura lacada visón mate.



6011 93 /15. 6007 93 /15.

Suite

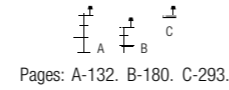
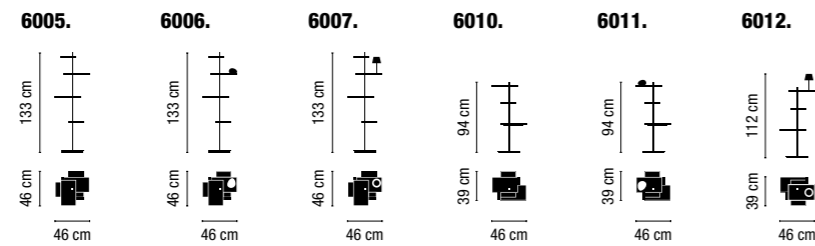

Pages: A-132. B-180. C-293.

Polycarbonate diffuser / Difusor de policarbonato.



	6005 14 /10. 6005 93 /10.	8 x LED STRIP 24V 1,63W.		
	6010 14 /10. 6010 93 /10.	6 x LED STRIP 24V 1,63W.		
Glass diffuser mounted on shelf with dimmable light / Difusor de vidrio montado en estante con luz regulable.	6006 14 /15. 6006 93 /15.	8 x LED STRIP 24V 1,63W. 1 x LED 4,5W 350mA.	14 Matt chocolate lacquer / Lacado marrón oscuro mate. 93 Matt white lacquer / Lacado blanco mate.	/10 2700°K Dimmable: No. /15. 2700 °K. Dimmable: Push.
	6011 14 /15. 6011 93 /15.	6 x LED STRIP 24V 1,63W. 1 x LED 4,5W 350mA.		
Reading light matt mink lacquer, mounted on shelf with dimmable light. / Luz de lectura lacada visón mate, montada en estante con luz regulable.	6007 14 /15. 6007 93 /15.	8 x LED STRIP 24V 1,63W. 1 x LED 4,5W 350mA.		
	6012 14 /15. 6012 93 /15.	6 x LED STRIP 24V 1,63W. 1 x LED 4,5W 350mA.		

Check additional product specifications at the end of this catalogue: Technical information / Consultar especificaciones adicionales del producto al final del catálogo: Información Técnica.

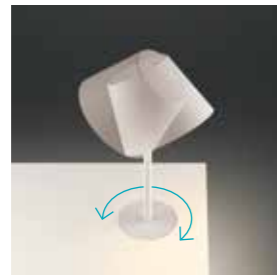

Adjustable reading light.
 USB charging connection.
 Double switch (6006. 6007. 6011. 6012.)
 - Push on / off for general lighting.
 - Dimmable push for reading lighting and glass diffuser.



Luz de lectura orientable.
 Conexión USB de carga.
 Doble interruptor (6006. 6007. 6011. 6012.)
 - Pulsador on/off para luz general
 - Pulsador regulable para luz de lectura o difusor de vidrio.



6007 93 /15.

North

Design by Arik Levy.



North, south, east and west are our points of references in space; we set-out, build and travel according to these coordinates.



5605 04 /15.



5620 04 /15.



5625 04 /15.



5605 04 /15. 5600 04 /15.

North

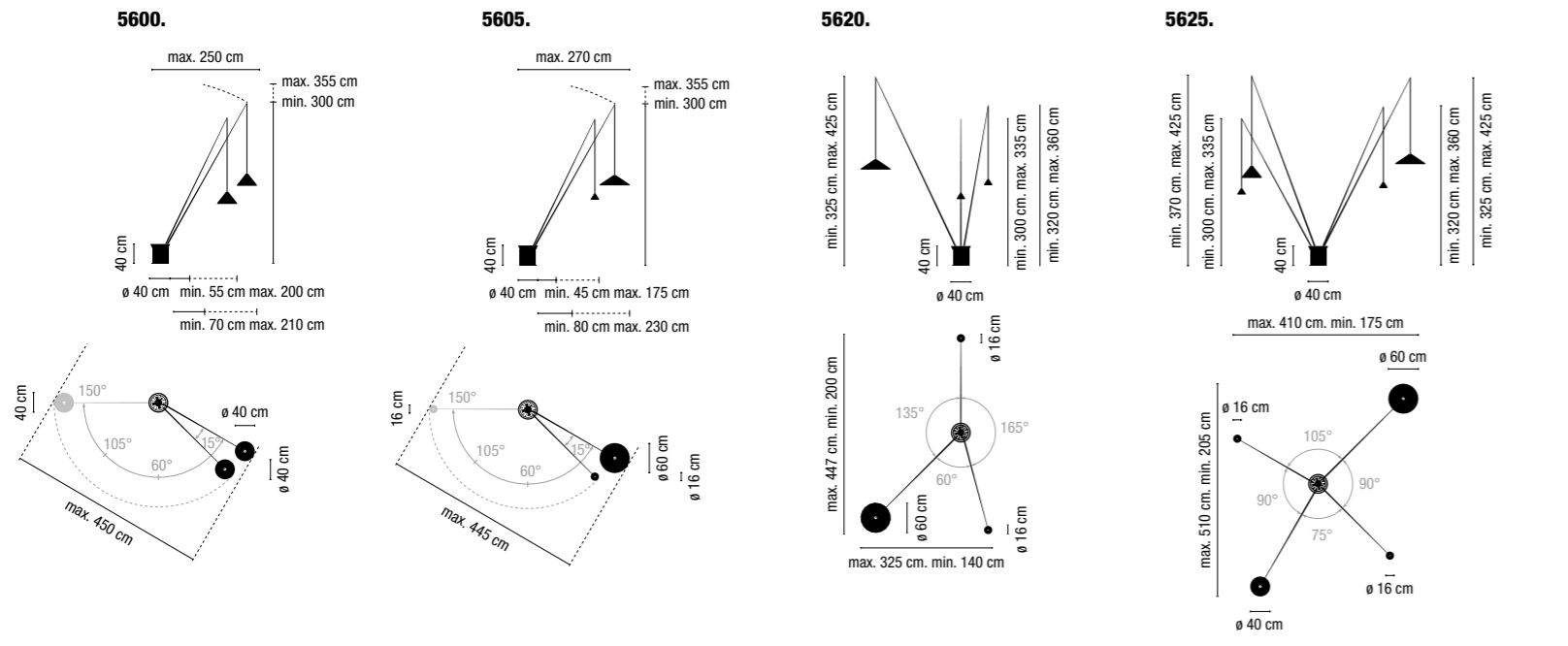

Aluminum Shade / Pantalla de aluminio.

LED IP20 CE

5600 04 /15. 5600 05 /15. 5600 58 /15. 5600 93 /15.	2 x LED 9W 350mA.	<ul style="list-style-type: none"> ● 04 Matt graphite lacquer / Lacado grafito mate. ● 05 Matt blue lacquer / Lacado azul mate. ● 58 Matt cream lacquer / Lacado crema mate. ● 93 Matt white lacquer / Lacado blanco mate. 	/15. 2700 °K. Dimmable: Push.
5605 04 /15. 5605 05 /15. 5605 58 /15. 5605 93 /15.			
5620 04 /15. 5620 05 /15. 5620 58 /15. 5620 93 /15.	3 x LED 9W 350mA.		
5625 04 /15. 5625 05 /15. 5625 58 /15. 5625 93 /15.	4 x LED 9W 350mA.		

Check additional product specifications at the end of this catalogue: Technical information / Consultar especificaciones adicionales del producto al final del catálogo: Información Técnica.

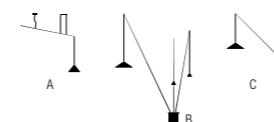

Pages: A-86. B-136. C-272.



Adjustable-angle rods / Ángulo de las cañas ajustable.

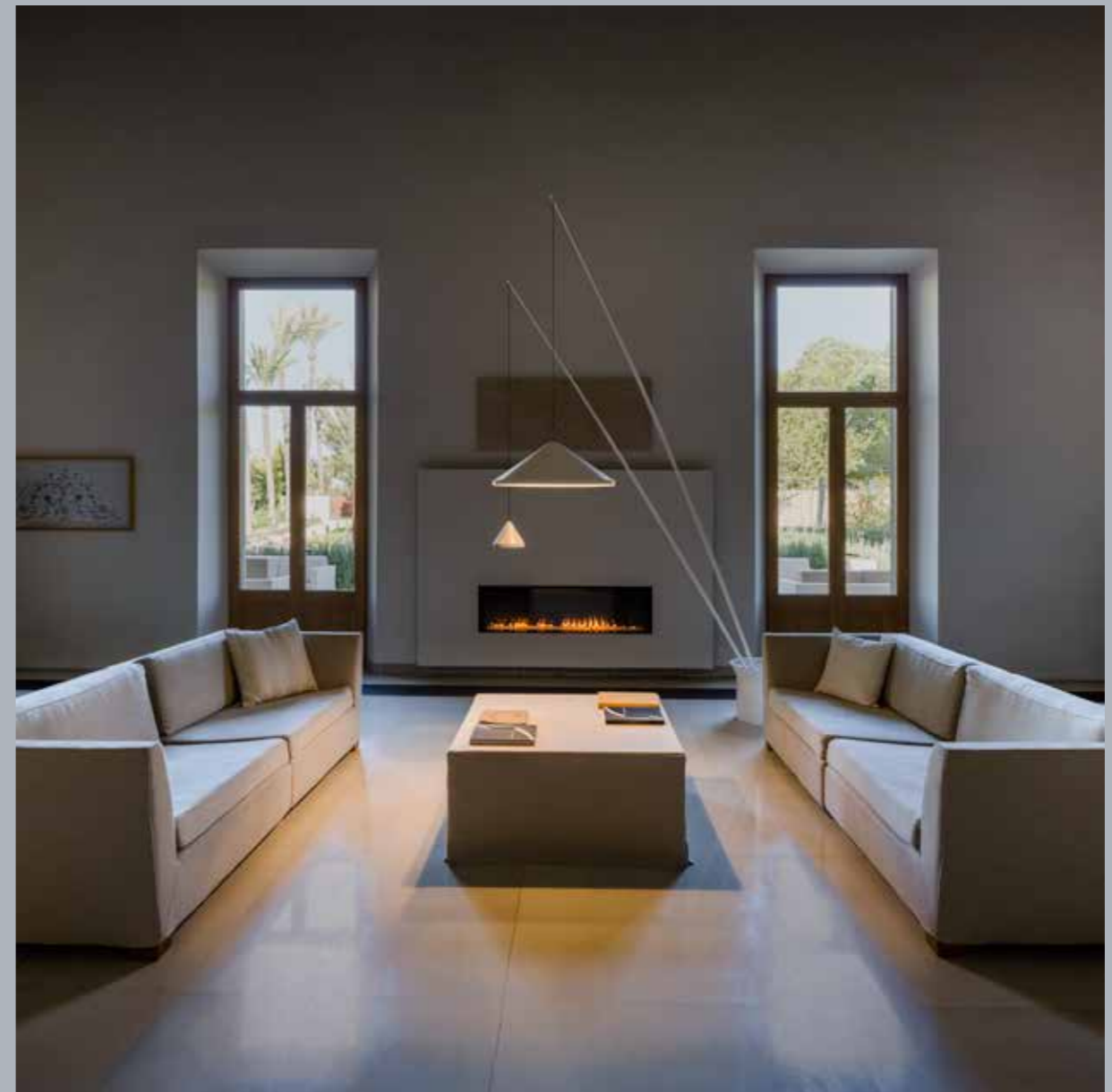

5605 93 /15.

Skan

Design by Lievore, Altherr, Molina.

Reintroducing the concept of a light fixture consisting on a conical shade with a light inside, updated using contemporary technology. We are not just evolving tradition, but fine tuning it.



0260 18 /15. 0260 06 /15. 0260 03 /15.



0260 03 /15.

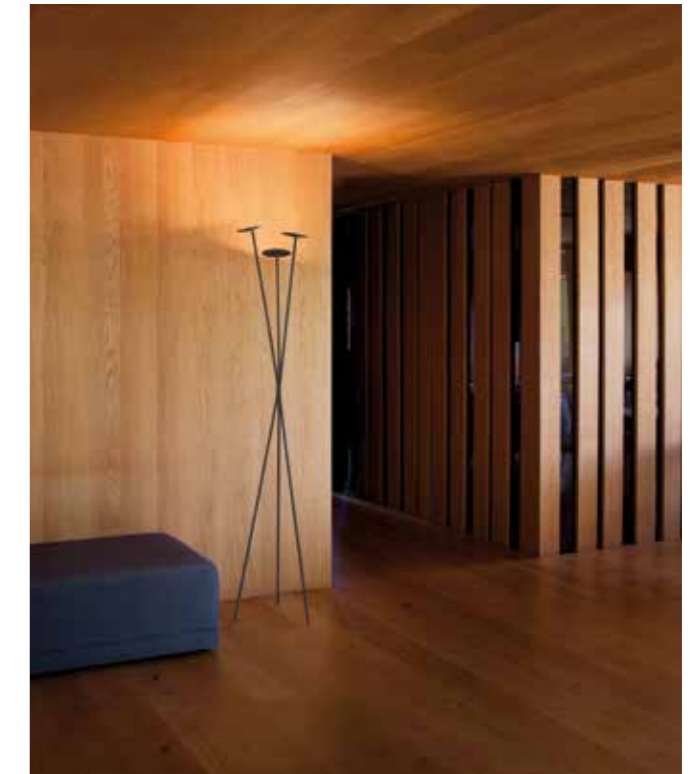

0260 04 /15.

0260.

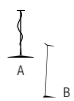
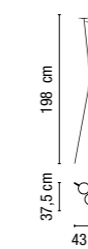

Pages: A-60. B-142.

Methacrylate diffuser / Difusor de metacrilato.



0260 03 /15.
0260 06 /15.
0260 18 /15.

3 x LED 8W 700mA.

03 Matt white lacquer / Lacado blanco mate.
06 Matt red lacquer / Lacado rojo mate.
18 Matt graphite grey / Lacado gris grafito.

vibia.com Finish customization at / Personaliza acabado en

/15.
2700 °K.
Dimmable: Push.

Dimmer on the cable / Regulador de intensidad en el cable.

Check additional product specifications at the end of this catalogue: Technical information / Consultar especificaciones adicionales del producto al final del catálogo: Información Técnica.

Skán



0250 18.



0250.

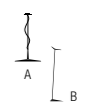

Pages: A-60. B-142.

Methacrylate diffuser / Difusor de metacrilato.



0250 03.
0250 06.
0250 18.

CONTENIDO: 1 x LED PLATE 24V 8W.

- **03** Matt white lacquer / Lacado blanco mate.
- **06** Matt red lacquer / Lacado rojo mate.
- **18** Matt graphite grey / Lacado gris grafito.
- **vibia.com** Finish customization at / Personaliza acabado en

Optical sensor dimming / Regulable mediante sensor óptico
Check additional product specifications at the end of this catalogue: Technical information / Consultar especificaciones adicionales del producto al final del catálogo: Información Técnica.

I.Cono

Design by Lievore, Altherr, Molina.



I.cono represents an exercise in the fully resolved harmony of the present and the future, following the most exquisite traditions.



0712 93.



0712 04.

Adjustable diffuser /
Cabezal orientable.

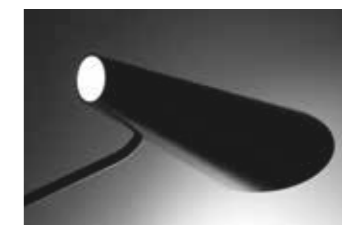

0712.

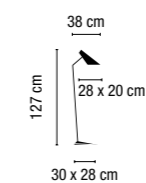

Pages: A-146. B-198. C-302.

Polycarbonate diffuser / Difusor de policarbonato.

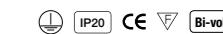

- 0712 03. 1 x LED STAR CLASSIC P40 E14 230V 6W.
- 0712 04. **OR** 1 x COMPACT FLUORESCENT E14 230V 15W. (MEGAMAN LILIPUT PLUS o similar) Max.
- 0712 59. **OR** 1 x E14 230V 46W Eco Max.

- 03 Gloss white lacquer / Lacado blanco brillo.
- 04 Gloss black lacquer / Lacado negro brillo.
- 59 Matt mink lacquer / Lacado visón mate.
- 93 Matt white lacquer / Lacado blanco mate.
- vibia.com** Finish customization at / Personaliza acabado en

On/off switch on the cable / Interruptor on/off en el cable.
Check additional product specifications at the end of this catalogue: Technical information /
Consultar especificaciones adicionales del producto al final del catálogo: Información Técnica.

Warm

Design by Ramos & Bassols.



Home sweet home.



4905 58.



4906 14. 4906 58. 4906 06.



4906 14.

4905. 4906.

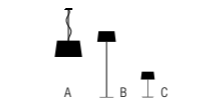
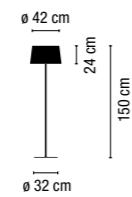

Pages: A-94. B-148. C-202.

Methacrylate diffuser / Difusor de metacrilato.



Screen shade / Pantalla Screen.	4905 58.	<ul style="list-style-type: none"> 3 x MASTER LEDBulb E27 230V 13W. OR 3 x COMPACT FLUORESCENT E27 230V 16W Max. (PHILIPS SOFTONE-DOBLE ENVELOPE) 	<ul style="list-style-type: none"> ● 58 Off-white matt lacquer / Lacado blanco roto mate.
Aluminum shade / Pantalla de aluminio.	4906 06. 4906 14. 4906 58.	<ul style="list-style-type: none"> 3 x MASTER LEDBulb E27 230V 13W. OR 3 x COMPACT FLUORESCENT E27 230V 20W Max. 	<ul style="list-style-type: none"> ● 06 Matt red lacquer / Lacado rojo mate. ● 14 Matt chocolate lacquer / Lacado marrón oscuro mate. ● 58 Off-white matt lacquer / Lacado blanco roto mate. vibia.com Finish customization at / Personaliza acabado en

On/off switch on the cable / Interruptor on/off en el cable.

Check additional product specifications at the end of this catalogue: Technical information / Consultar especificaciones adicionales del producto al final del catálogo: Información Técnica.

Warm



4905 58.



Swing

Design by Lievore, Altherr, Molina.



Refined movement, pure tradition.



0503 18. 0507 18.



0516 18.

Swing



0503 18. 0503 93.



0516 01 /10. 0516 18 /10. 0516 93 /10.

0503.

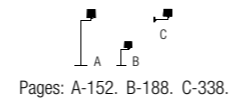
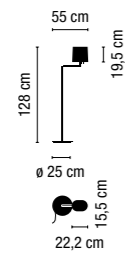

Pages: A-152. B-188. C-338.

0516.

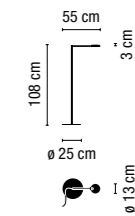

Screen shade / Pantalla Screen. Switch on the lampholder / Interruptor en el portalámparas.	0503 01. 0503 18. 0503 93.	<ul style="list-style-type: none"> 1 x Core Pro LEDbulb E27 230V 9W. OR 1 x COMPACT FLUORESCENT E27 230V 15W Max. OR 1 x E27 230V 70W Eco Max. 		<ul style="list-style-type: none"> 01 Chrome / Cromo. 18 Matt graphite lacquer / Lacado grafito mate. 93 Matt white lacquer / Lacado blanco mate.
---	---	---	--	---

Adjustable metal diffuser / Difusor de metal orientable. On/off switch on the cable / Interruptor on/off en el cable.	0516 01 /10. 0516 18 /10. 0516 93 /10.			<ul style="list-style-type: none"> 01 Chrome / Cromo. 18 Matt graphite lacquer / Lacado grafito mate. 93 Matt white lacquer / Lacado blanco mate. 	/10 2700°K Dimmable: No.
--	---	--	--	---	---------------------------------------

Check additional product specifications at the end of this catalogue: Technical information /
Consultar especificaciones adicionales del producto al final del catálogo: Información Técnica.

Check additional product specifications at the end of this catalogue: Technical information /
Consultar especificaciones adicionales del producto al final del catálogo: Información Técnica.

Jazz

Design by Diego Fortunato.

Sculptural design with a marked sensual but strong character. Ancestral forms converted into modern design icons.



1330-03.



1330-04. 1330-59. 1330-93.

Jazz



1330 03.
Gloss white lacquer /
Lacado blanco brillo.

1330 93.
Matt white lacquer /
Lacado blanco mate.

1330.

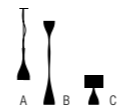
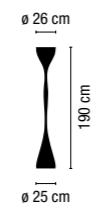

Pages: A-106. B-156. C-192.

Rigid high-density resin / Resina rígida de alta densidad.

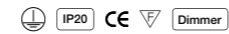

1330 03.
1330 04.
1330 06.
1330 59.
1330 93.

1 x R7s 117mm 230V 400W Eco.

- 03** Gloss white lacquer / Lacado blanco brillo.
 - 04** Gloss black lacquer / Lacado negro brillo.
 - 06** Gloss red lacquer / Lacado rojo brillo.
 - 59** Matt mink lacquer / Lacado visión mate.
 - 93** Matt white lacquer / Lacado blanco mate.
- vibia.com** Finish customization at / Personaliza acabado en

Dimmer on the cable / Regulador de intensidad en el cable.
Check additional product specifications at the end of this catalogue: Technical information /
Consultar especificaciones adicionales del producto al final del catálogo: Información Técnica.



1330 03.

Balance

Design by Jordi Vilardell.



A timeless classic which exudes elegance and warmth.



5189 18.

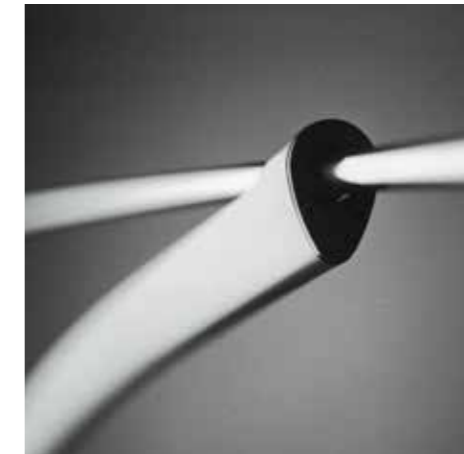

Balance



5191-01.

5189. 5190.

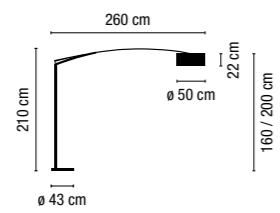

5191. 5192.

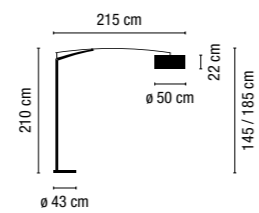

IP20 CE Dimmer Bi-volt

<p>Aluminum-weft diffuser / Difusor de trama de aluminio.</p>	<p>5189 01. 5192 01. 5189 18. 5192 18. 5189 30. 5192 30.</p>	<p>01 Chrome / Cromo. 18 Matt graphite lacquer / Lacado grafito mate. 30 Matt nickel / Níquel mate.</p>	<p>3 x E27 230V 70W Eco.</p>
<p>Cotton finish diffuser / Difusor acabado algodón.</p>	<p>5190 01. 5191 01. 5190 30. 5191 30.</p>	<p>01 Chrome / Cromo. 30 Matt nickel / Níquel mate.</p>	

Dimmer on the cable / Regulador de intensidad en el cable.

Check additional product specifications at the end of this catalogue: Technical information /
Consultar especificaciones adicionales del producto al final del catálogo: Información Técnica.



5189 01.

Mayfair

Design by Diego Fortunato.



The Mayfair light fitting represents an evolution from 18th Century lamps. While also featuring the most advanced lighting technology and retaining its charm and ability to delight.



5515 18 /16. 5515 93 /16. 5515 20 /16. 5515 67 /16.

Mayfair

5510. 5515.

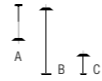
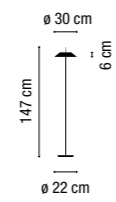

Pages: A-74. B-164. C-170.

Polycarbonate diffuser / Difusor de policarbonato.



Methacrylate shade / Pantalla de metacrilato.	5510 07 /16.	07 Gloss black nickel and green / Níquel negro brillante y verde.	 1 x LED STRIP 24V 2,4W. 1 x LED STRIP 24V 16,8W.	/16. 2700 °K. Dimmable: Optical Sensor
	5510 08 /16.	08 Gloss black nickel and orange / Níquel negro brillante y naranja.		
Steel shade / Pantalla de acero.	5515 18 /16.	18 Matt graphite lacquer / Lacado grafito mate.		
	5515 20 /16.	20 Matt gold / Oro satinado mate.		
	5515 67 /16.	67 Gloss copper / Cobre brillo.		
	5515 93 /16.	93 Matt white lacquer / Lacado blanco mate.		

Check additional product specifications at the end of this catalogue: Technical information /
Consultar especificaciones adicionales del producto al final del catálogo: Información Técnica.



5505 18 /16. 5515 18 /16.

5515 93 /16.



5110 07 /16. 5110 08 /16.



5515 20 /16.

Table

Updating Legacy,
Smooth Touch,
Delicate Sense...

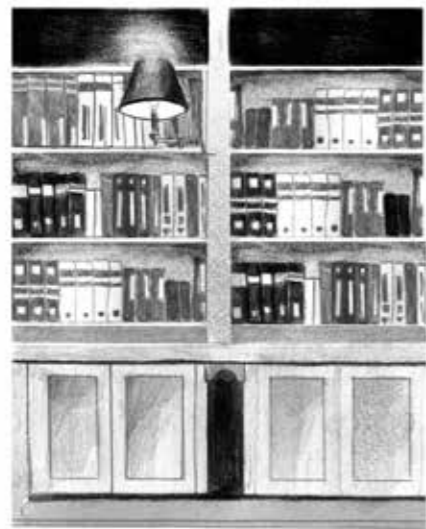

Updating Legacy
Combining
progress with the
most authentic
and essential
values; showing
respect for the best
from the past, a
reinterpretation
within a
contemporary
context with a view
to the future.



Smooth Touch
The surprise
of contrasting
perceptions, like
how hard can be
smooth or the
solidity of the subtle
and the sensations
that are given off
unconsciously
through touch and
sight.



Delicate Sense
Amiable products,
born with a
sensibility and
finesse at the
moment of
conception present
throughout their
development,
values that are
passed on to the
spaces they light.
The delicacy that
is innate through
their conceptual,
formal, material
and functional
expression.

Table



Flex
pag. 184



I.Cono
pag. 198



Jazz
pag. 192



Join
pag. 194



Mayfair
pag. 170



Pin
pag. 176



Suite
pag. 180



Swing
pag. 188



Warm
pag. 202

Mayfair

Design by Diego Fortunato.



The Mayfair light fitting represents an evolution from 18th Century lamps. While also featuring the most advanced lighting technology and retaining its charm and ability to delight.

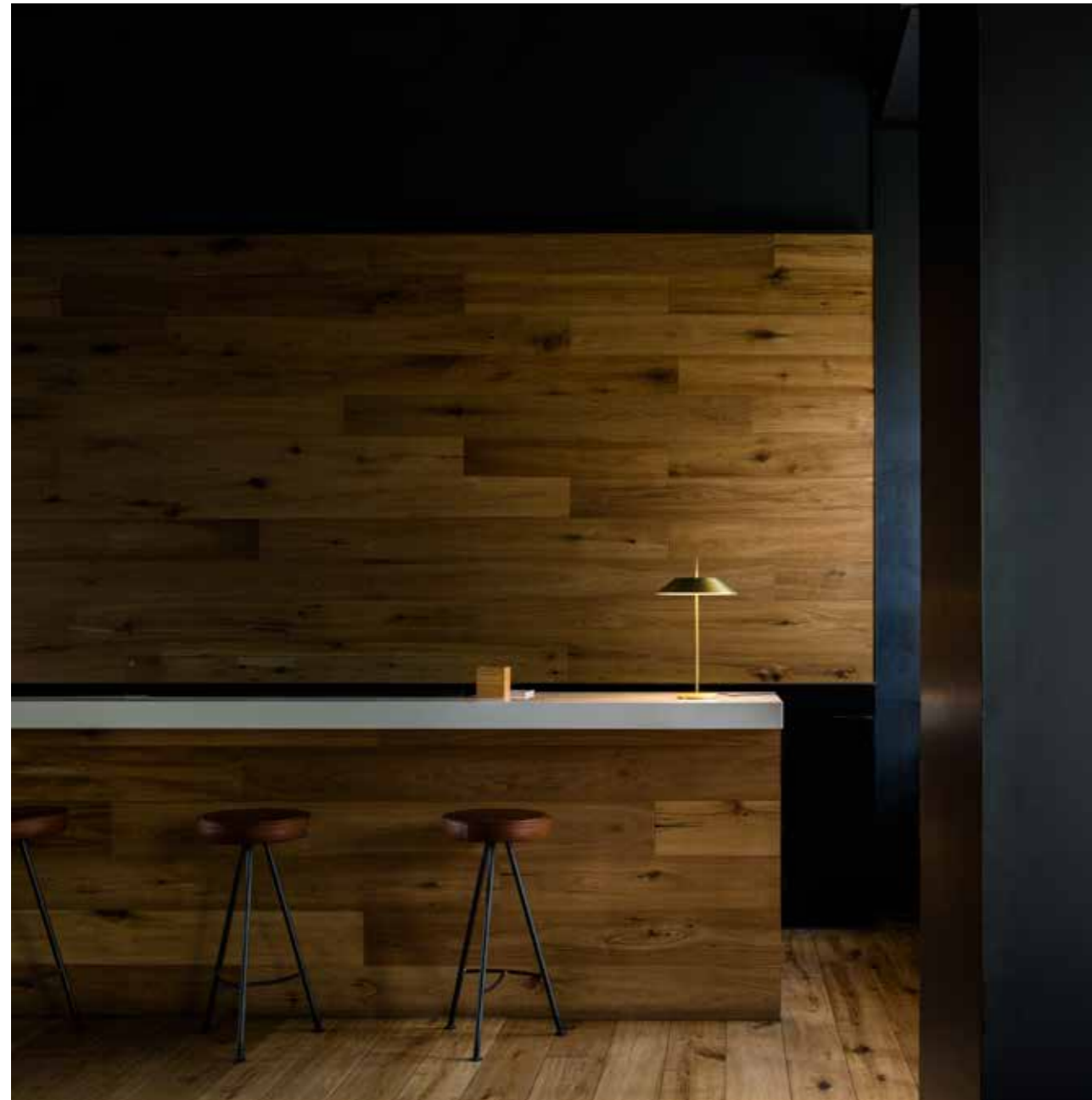

5505 20 /16.



5505 67 /16. 5505 20 /16.

Mayfair



5505 93 /16.



5505 93 /16. 5505 18 /16.

Mayfair

5500. 5505.

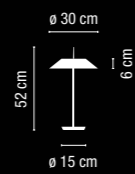

Pages: A-74. B-164. C-170.

Polycarbonate diffuser / Difusor de policarbonato.

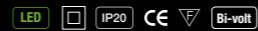

Methacrylate shade / Pantalla de metacrilato.	5500 07 /16.	 07 Gloss black nickel and green / Niquel negro brillante y verde.	1 x LED STRIP 24V 2,4W.	/16. 2700 °K. Dimmable: Optical Sensor.
	5500 08 /16.	 08 Gloss black nickel and orange / Niquel negro brillante y naranja.		
Steel shade / Pantalla de acero.	5505 18 /16.	 18 Matt graphite lacquer / Lacado grafito mate.	1 x LED STRIP 24V 16,8W.	
	5505 20 /16.	 20 Matt gold / Oro satinado mate.		
	5505 67 /16.	 67 Gloss copper / Cobre brillo.		
	5505 93 /16.	 93 Matt white lacquer / Lacado blanco mate.		

Check additional product specifications at the end of this catalogue: Technical information /
Consultar especificaciones adicionales del producto al final del catálogo: Información Técnica.



5500 08 /16. 5500 07 /16.

Pin

Design by Ichiro Iwasaki



Despite the ongoing diversification of values among people living in the present age, a lot of people still cherish comfort of life as it has always been.



1655 04 /10.



1655 04 /10. 1650 04 /10.

Pin

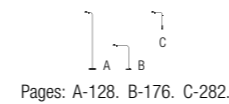
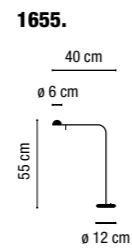
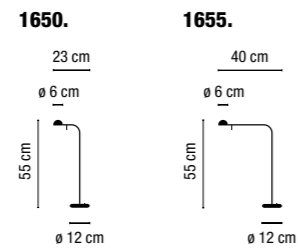

Pages: A-128. B-176. C-282.

Polycarbonate diffuser / Difusor de policarbonato.

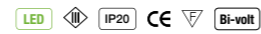

1650 04 /10. 1655 04 /10.
1650 58 /10. 1655 58 /10.
1650 62 /10. 1655 62 /10.
1650 93 /10. 1655 93 /10.

1 x LED 4,5W 350mA.

- **04** Matt black lacquer / Lacado negro mate.
- **58** Matt cream lacquer / Lacado crema mate.
- **62** Matt green lacquer / Lacado verde mate.
- **93** Matt white lacquer / Lacado blanco mate.

/10.
 2700 °K.
 Dimmable: No.

Check additional product specifications at the end of this catalogue: Technical information / Consultar especificaciones adicionales del producto al final del catálogo: Información Técnica.



1650 62/10. 1655 04/10. 1650 93/10. 1650 58/10.

Suite

Design by Jordi Vilardell & Meritxell Vidal.



Reinterprets and updates the traditional combination of side table or shelf with table lamp. Its warm and comfortable lighting effect appears when least expected, a pleasant luminous surprise.



6031 93 /15. 6032 93 /15.



Reading light matt mink lacquer /
Luz de lectura lacada visón mate.



Adjustable reading light.
 USB charging connection.
 Double switch (6026, 6027, 6031, 6032.)
 - Push on / off for general lighting.
 - Dimmable push for reading lighting and glass diffuser.

Luz de lectura orientable.
 Conexión USB de carga.
 Doble interruptor (6026, 6027, 6031, 6032.)
 - Pulsador on/off para luz general
 - Pulsador regulable para luz de lectura o difusor de vidrio.

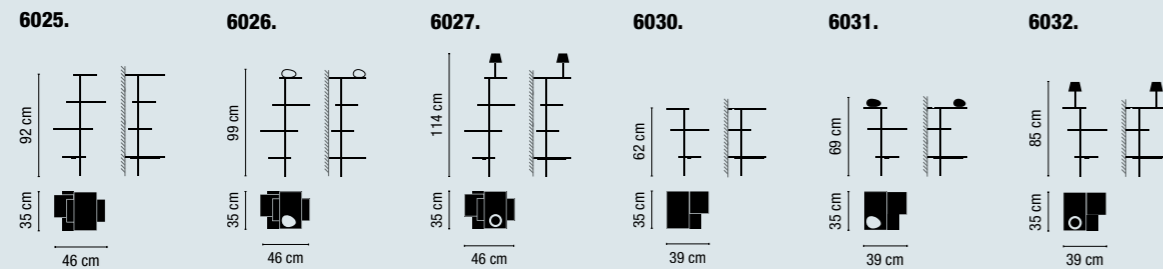

Pages: A-132, B-180, C-293.

Polycarbonate diffuser / Difusor de policarbonato.



	6025 14 /10. 6025 93 /10.	8 x LED STRIP 24V 1,63W.	
Glass diffuser mounted on shelf with dimmable light / Difusor de vidrio montado en estante con luz regulable.	6026 14 /15. 6026 93 /15.	8 x LED STRIP 24V 1,63W. 1 x LED 4,5W 350mA.	
Reading light matt mink lacquer, mounted on shelf with dimmable light / Luz de lectura lacada visón mate, montada en estante con luz regulable.	6027 14 /15. 6027 93 /15.	8 x LED STRIP 24V 1,63W. 1 x LED 4,5W 350mA.	
	6030 14 /10. 6030 93 /10.	6 x LED STRIP 24V 1,63W.	
Glass diffuser mounted on shelf with dimmable light / Difusor de vidrio montado en estante con luz regulable.	6031 14 /15. 6031 93 /15.	6 x LED STRIP 24V 1,63W. 1 x LED 4,5W 350mA.	
Reading light matt mink lacquer, mounted on shelf with dimmable light / Luz de lectura lacada visón mate, montada en estante con luz regulable.	6032 14 /15. 6032 93 /15.	6 x LED STRIP 24V 1,63W. 1 x LED 4,5W 350mA.	

- **14** Matt chocolate lacquer / Lacado marrón oscuro mate.
- **93** Matt white lacquer / Lacado blanco mate.

/10
2700°K
Dimmable: No.

/15.
2700 °K.
Dimmable: Push.

Check additional product specifications at the end of this catalogue: Technical information / Consultar especificaciones adicionales del producto al final del catálogo: Información Técnica.

Suite



6032 93 /15. 6031 93 /15.



6030 14 /10. 6027 14 /15.

Flex

Design by Ramos & Bassols.



A visually slender and stylish silhouette,
with seamlessly flexible forms that combine functionality
with a pure formal language.



0750 03.

Flex

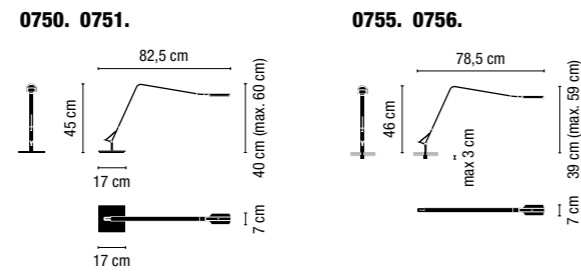

Acrylic diffuser / Difusor de metacrilato.

LED IP20 CE Dimmer Bi-volt

<p>0750 03. 0755 03. 0750 18. 0755 18.</p>	<p>● 03 Gloss white lacquer / Lacado blanco brillo. ● 18 Gloss graphite lacquer / Lacado grafito brillo.</p>
<p>0751 03. 0756 03. 0751 18. 0756 18.</p>	<p>● 03 Matt white lacquer / Lacado blanco mate. ● 18 Matt graphite lacquer / Lacado grafito mate.</p>

1 x LED PLATE 24V 8W.

Optical sensor dimming / Regulable mediante sensor óptico.
Check additional product specifications at the end of this catalogue: Technical information /
Consultar especificaciones adicionales del producto al final del catálogo: Información Técnica.



Anti-glare system /
Sistema anti-deslumbramiento.

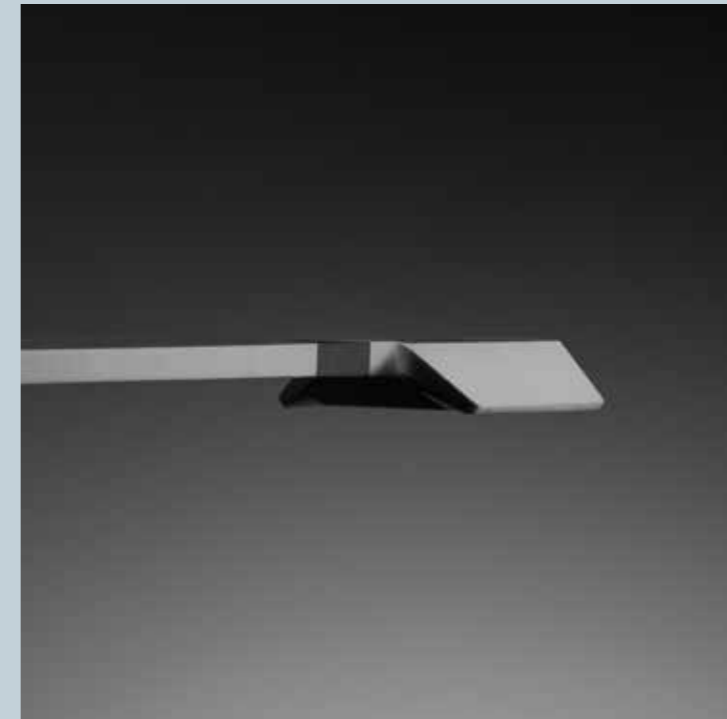

0750 18. 0750 03.

Swing

Design by Lievore, Altherr, Molina.



Refined movement, pure tradition.



0507 18.



0521 93 /10.

Swing



0507.

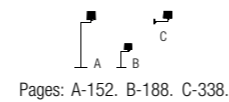
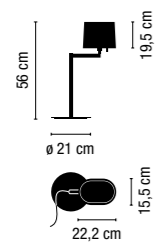

Pages: A-152. B-188. C-338.

0521.

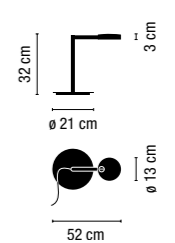

<p>Screen shade. Switch on the lampholder. / Pantalla Screen. Interruptor en el portalámparas.</p>	<p>0507 01. 0507 18. 0507 93.</p>	<p>1 x Core Pro LEDbulb E27 230V 9W. OR 1 x COMPACT FLUORESCENT E27 230V 15W Max. OR 1 x E27 230V 70W Eco Max.</p>	<p>IP20 CE Bi-volt</p>	<p>01 Chrome / Cromo. 18 Matt graphite lacquer / Lacado grafito mate. 93 Matt white lacquer / Lacado blanco mate.</p>
--	--	--	------------------------	---

Check additional product specifications at the end of this catalogue: Technical information / Consultar especificaciones adicionales del producto al final del catálogo: Información Técnica.

<p>Adjustable metal diffuser. On/off switch on the cable. / Difusor de metal orientable. Interruptor on/off en el cable.</p>	<p>0521 01 /10. 0521 18 /10. 0521 93 /10.</p>	<p>1 x LED 5,25W 500mA.</p>	<p>LED IP20 CE</p>	<p>01 Chrome / Cromo. 18 Matt graphite lacquer / Lacado grafito mate. 93 Matt white lacquer / Lacado blanco mate.</p>	<p>/10 2700°K Dimmable: No.</p>
--	--	-----------------------------	--------------------	---	---

Check additional product specifications at the end of this catalogue: Technical information / Consultar especificaciones adicionales del producto al final del catálogo: Información Técnica.

Jazz

Design by Diego Fortunato.

Sculptural design with a marked sensual but strong character. Ancestral forms converted into modern design icons.

1332.

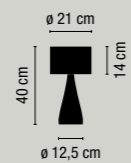

1333.

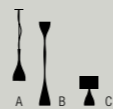
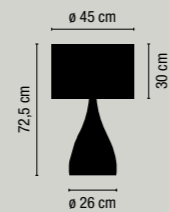

Pages: A-106, B-156, C-192.

Aluminum diffuser / Difusor de aluminio.



Mini	1332 03. 1332 04. 1332 06. 1332 59. 1332 93.	3 x LED G9 230V 3W 2800K MEGAMAN. OR 3 x COMPACT FLUORESCENT G9 230V 7W Max. OR 3 x G9 230V 40W Max.	<ul style="list-style-type: none"> 03 Gloss white lacquer / Lacado blanco brillo. 04 Gloss black lacquer / Lacado negro brillo. 06 Gloss red lacquer / Lacado rojo brillo. 59 Matt mink lacquer / Lacado visión mate. 93 Matt white lacquer / Lacado blanco mate. <p> vibia.com Finish customization at / Personaliza acabado en</p>
	1333 03. 1333 04. 1333 06. 1333 59. 1333 93.	4 x Core Pro LEDbulb E27 230V 10W. OR 4 x COMPACT FLUORESCENT E27 230V 11W Max. OR 4 x E27 230V 46W Eco Max.	

Check additional product specifications at the end of this catalogue: Technical information / Consultar especificaciones adicionales del producto al final del catálogo: Información Técnica.



1333 04. 1333 06. 1333 03.

Join

Design by Jordi Vilardell.



Monolithic materiality, an homage to the purity of glass.
A warm beacon of light within.



5066.



5068.

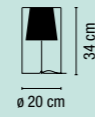

Borosilicate glass diffuser / Difusor de vidrio de borosilicato.	5066 01.	● 01 Borosilicate glass / Vidrio de borosilicato.	□ IP20 CE ▽ Bi-volt	➤ 1 x G9 230V 48W Eco.
Blown glass diffuser / Difusor de vidrio soplado.	5068 01.	● 01 Blown-glass / Vidrio soplado.	□ IP20 CE ▽ Dimmer Bi-volt	

Check additional product specifications at the end of this catalogue: Technical information /
Consultar especificaciones adicionales del producto al final del catálogo: Información Técnica.





5068-01.
Dimmer on the cable /
Regulador de intensidad en el cable.



5066 01.

I.Cono

Design by Lievore, Altherr, Molina.



I.Cono represents an exercise in the fully resolved harmony of the present and the future, following the most exquisite traditions.



0700 03.



0700 04.

I.Cono



0700.

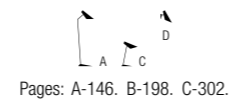
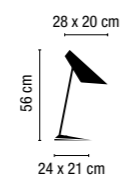





Pages: A-146. B-198. C-302.

Polycarbonate diffuser / Difusor de policarbonato.



- 0700 03.** 1 x LED STAR CLASSIC P40 E14 230V 6W.
- 0700 04.** **OR** 1 x COMPACT FLUORESCENT E14 230V 15W.
(MEGAMAN LILIPUT PLUS o similar) Max.
- 0700 93.** **OR** 1 x E14 230V 46W Eco Max.

-  **03** Gloss white lacquer / Lacado blanco brillo.
-  **04** Gloss black lacquer / Lacado negro brillo.
-  **59** Matt mink lacquer / Lacado visón mate.
-  **93** Matt white lacquer / Lacado blanco mate.
-  **vibia.com** Finish customization at / Personaliza acabado en

On/off switch on the base / Interruptor en la base.

Check additional product specifications at the end of this catalogue: Technical information / Consultar especificaciones adicionales del producto al final del catálogo: Información Técnica.



0700 59.

Warm

Design by Ramos & Bassols.



Home sweet home.



4901 58. 4896 58.



4896 58.

Warm

4895. 4896.

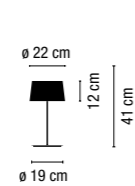

4900. 4901.

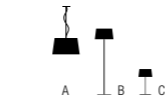
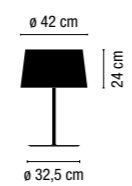

Pages: A-94. B-148. C-202.



Screen shade / Pantalla Screen.		Mini	4895 58.	3 x LED G9 230V 3W 2800K MEGAMAN.	58 Off-white matt lacquer / Lacado blanco roto mate.
	Methacrylate diffuser / Difusor de metacrilato.		4900 58.	3 x MASTER LEDBulb E27 230V 13W. OR 3 x COMPACT FLUORESCENT E27 230V 16W Max. (Philips Softone-Doble Envelope)	
Aluminum shade / Pantalla de aluminio.		Mini	4896 06. 4896 14. 4896 58.	3 x LED G9 230V 3W 2800K MEGAMAN.	06 Matt red lacquer / Lacado rojo mate. 14 Matt chocolate lacquer / Lacado marrón oscuro mate. 58 Off-white matt lacquer / Lacado blanco roto mate. vibia.com Finish customization at / Personaliza acabado en
	Methacrylate diffuser / Difusor de metacrilato.		4901 06. 4901 14. 4901 58.	3 x MASTER LEDBulb E27 230V 13W. OR 3 x COMPACT FLUORESCENT E27 230V 20W Max.	

Check additional product specifications at the end of this catalogue: Technical information /
Consultar especificaciones adicionales del producto al final del catálogo: Información Técnica.

4901 58. 4901 06. 4901 14.



4901 58.



4895 58.



4901 14.



4901 06.

Warm



4900 58. 4905 58.

Ceiling

Community of Lights,
Volume Modulation,
Skylights...

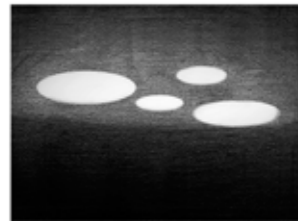

Community of Lights
With the combination of practical elements personalised compositions can be achieved, communities of lights that merge their photometric power through a single luminous creation.



Skylights
The way natural light enters a building represents a meeting of man-made construction and the natural world; how to reproduce the same effect and sensation, capturing the sky within indoors spaces.

Volume Modulation
There is no light without shadow, both phenomenon construct and modulate, generate volume and delimit space. The different grades of opacity and texture help us to interpret the context and exist within its constituent elements.

Ceiling



Big
pag. 230



Big Built-in
pag. 234



Centric
pag. 218



Domo
pag. 254



Funnel
pag. 258



Link
pag. 222



Link XXL
pag. 226



Plus
pag. 246



Puck
pag. 238



Quadra Ice
pag. 268



Scotch
pag. 262



Stage
pag. 266



Up
pag. 210



45°
pag. 242

Up

Design by Ramos & Bassols.



Light from beyond the ceiling. Light from a roof void traced by an exquisite silhouette inspired by classical cornices made contemporary.



Surface fitting.
New LED flat diffusion system.

Instalación de superficie.
Nuevo sistema LED de difusión plana.





4440 18 /1A. 4442 18 /1A.



4440 93 /1A.

Up



4460 18 /1A.

Up



4452 18 /1A. 4454 18 /1A.

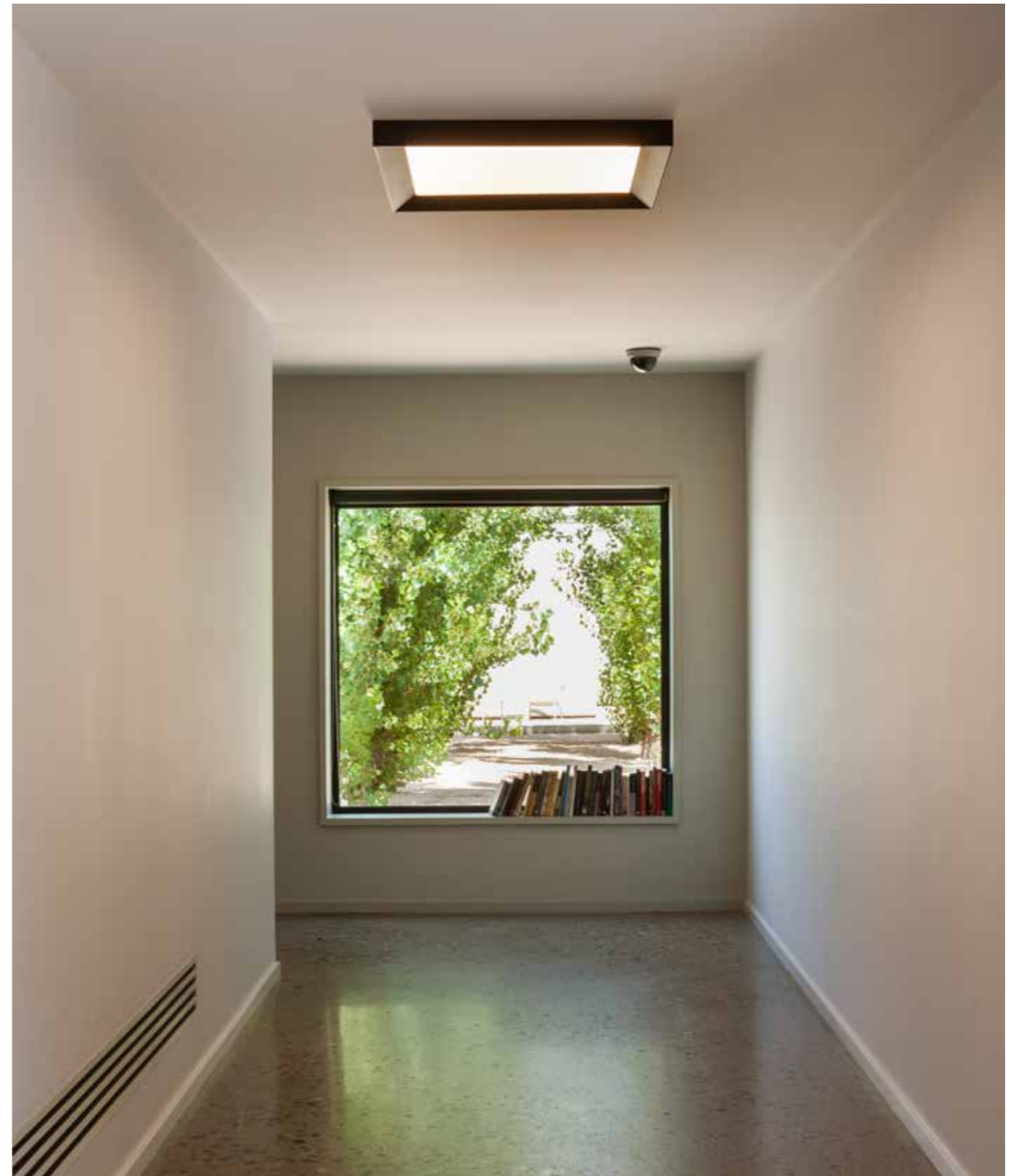

4454 18 /1A.

Up



4452 18 /1A. 4454 18 /1A.



4440 93 /1A. 4442 93 /1A.



4460 93 /1A.

4440.



4442.

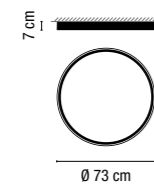

4460.

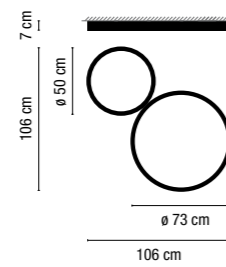

4452.

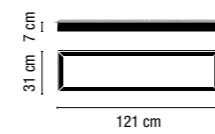

4454.

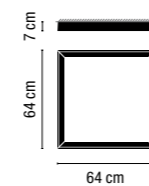

Policarbonate diffuser / Difusor de policarbonato.



4440 18 /1A. 4440 18 /4A.
4440 93 /1A. 4440 93 /4A.

1 x LED PLATE 26,5W 700mA..

4442 18 /1A. 4442 18 /4A.
4442 93 /1A. 4442 93 /4A.

1 x LED PLATE 55,3W 750mA.

4452 18 /1A. 4452 18 /4A.
4452 93 /1A. 4452 93 /4A.

1 x LED PLATE 50W 900mA.

4454 18 /1A. 4454 18 /4A.
4454 93 /1A. 4454 93 /4A.

1 x LED PLATE 26,5W 700mA.

1 x LED PLATE 55,3W 750mA.

18 Matt graphite lacquer / Lacado grafito mate.
93 Matt white lacquer / Lacado blanco mate.

/1A.
2700 °K.
Dimmable:1-10V + DALI + Push.
/4A.
4000 °K.
Dimmable:1-10V + DALI + Push.

Check additional product specifications at the end of this catalogue: Technical information / Consultar especificaciones adicionales del producto al final del catálogo: Información Técnica.

Centric

Design by Ramos & Bassols.



Some design objects can integrate with the architecture,
influencing it by making rooms come alive.



5700 93 /1B.

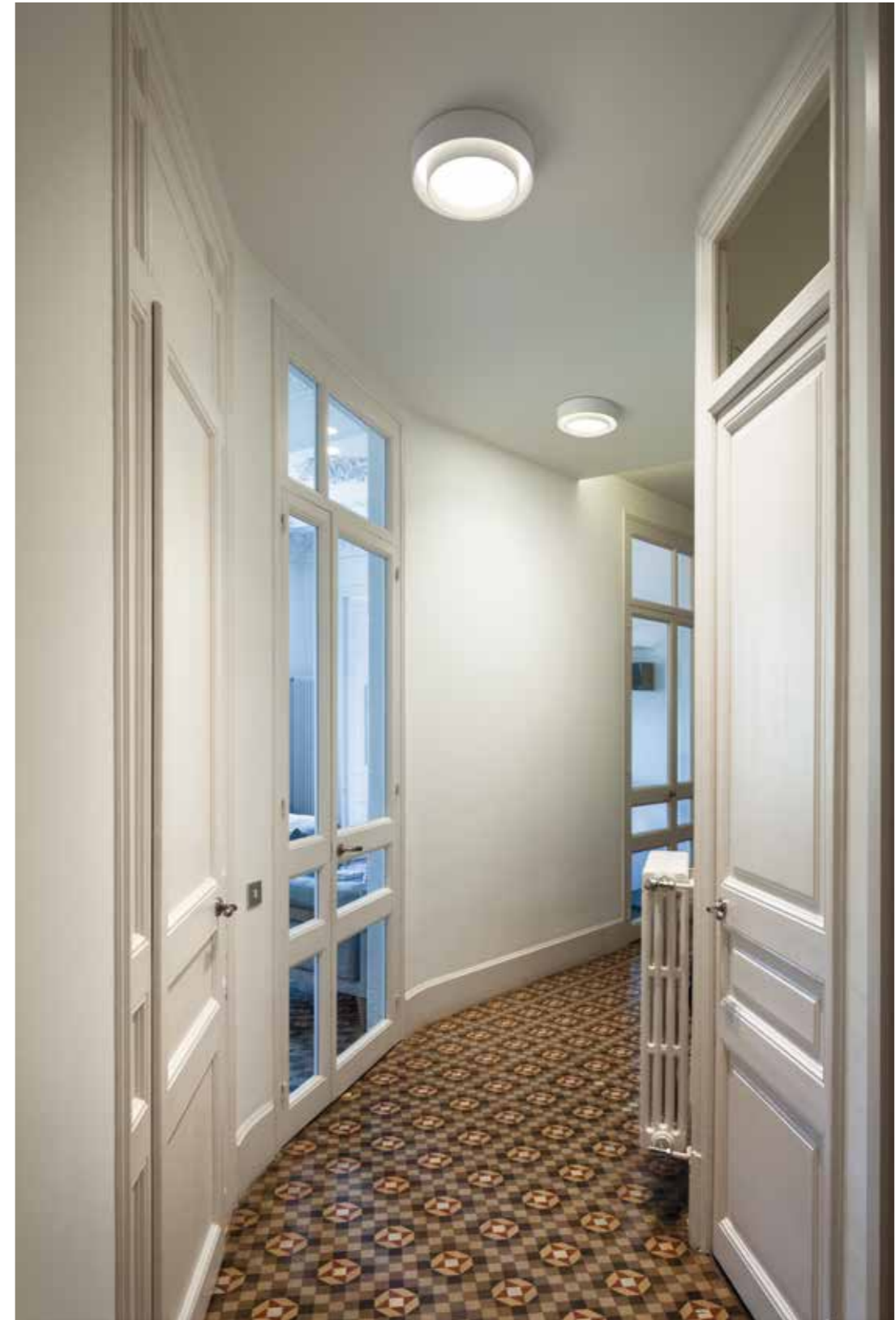

5710 93 /1B.



5710 93 /1B.

5700.

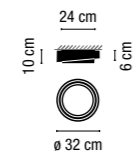

5710.

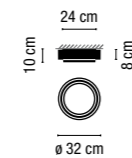

Pages: A-218. B-316.

Methacrylate diffuser / Difusor de metacrilato.



5700 58 /1B. 5710 58 /1B.
5700 93 /1B. 5710 93 /1B.

1 x LED PLATE 15.2W 700mA.
2 x LED STRIP 4W 700mA.

58 Matt cream lacquer / Lacado crema mate.
93 Matt white lacquer / Lacado blanco mate.

/1B.
2700 °K.
Dimmable: 1-10V + Push.

Check additional product specifications at the end of this catalogue: Technical information /
Consultar especificaciones adicionales del producto al final del catálogo: Información Técnica.

Centric



5710 58 /1B. 5700 93 /1B.

Link

Design by Ramón Esteve.



The intention is to form part of the ceiling as if there had been an accident leaving gaps and voids from which light emerges.



5395 03.



5380. 5381.



5384. 5385.



5388. 5389.



5395. 5396.



5373.

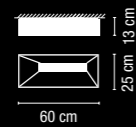

5376.

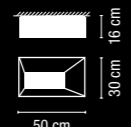

5379.



5380. 5381.

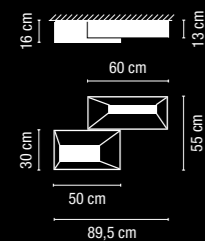

5384. 5385.

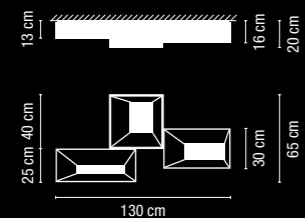

5388. 5389.

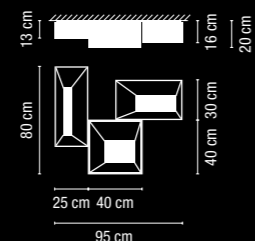

5395 / 5396.

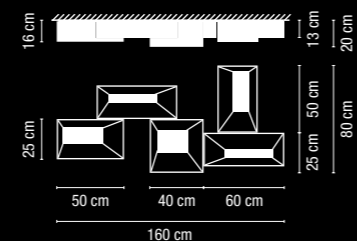

Acrylic diffuser / Difusor de metacrilato.

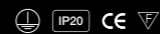

	5373 03. 5376 03. 5373 18. 5376 18.	2 x 2G11 230V 24W.	2 x 2G11 230V 18W.
	5379 03. 5379 18.	4 x 2G11 230V 24W.	
	5381 03. 5381 18.	4 x 2G11 230V 24W.	4 x 2G11 230V 18W.
	5385 03. 5389 03. 5385 18. 5389 18.	8 x 2G11 230V 24W.	4 x 2G11 230V 18W.
	5396 03. 5396 18.	12 x 2G11 230V 24W.	8 x 2G11 230V 18W.
Dimmable electronic ballast DALI System and Push / Reactancia electrónica regulable Sistema DALI y Push.	5380 03. 5380 18.	4 x 2G11 230V 24W.	4 x 2G11 230V 18W.
	5384 03. 5388 03. 5384 18. 5388 18.	8 x 2G11 230V 24W.	4 x 2G11 230V 18W.
	5395 03. 5395 18.	12 x 2G11 230V 24W.	8 x 2G11 230V 18W.

- 03 Gloss white lacquer / Lacado blanco brillo.
- 18 Gloss graphite grey / Lacado grafito brillo.

Check additional product specifications at the end of this catalogue: Technical information / Consultar especificaciones adicionales del producto al final del catálogo: Información Técnica.



Link



5380 18.

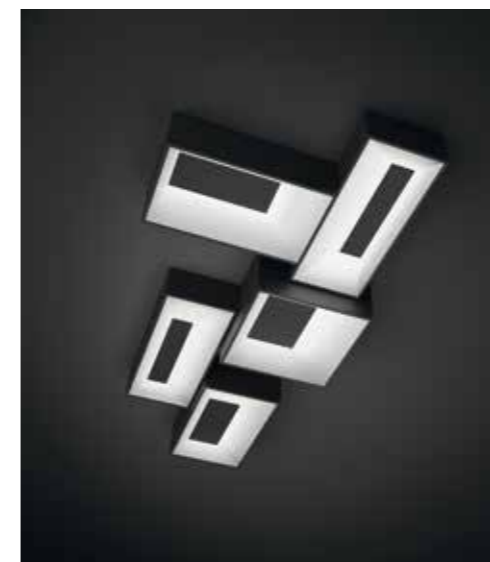

5395 18. 5396 18.

Create your product configuration quickly and easily at vibia.com

Go to vibia.com and discover the quickest, most effective way to configure a unique Link design.

Crea tu configuración de producto rápido y fácil en vibia.com

Entra en vibia.com y descubre la manera más rápida y eficiente de configurar un diseño único de Link.

Link XXL

Design by Ramón Esteve.



Like the skyline of a great city...
The modules of the Link lighting system create
interior architecture to suit any room.



Link XXL

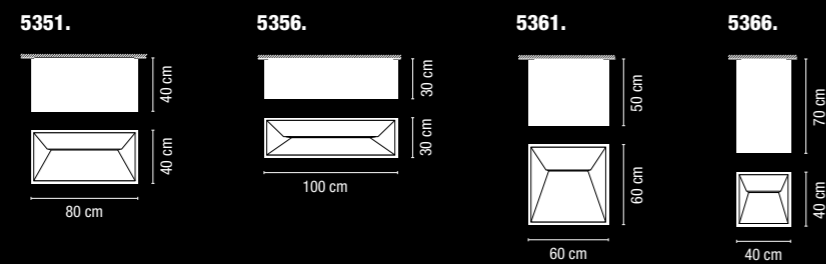
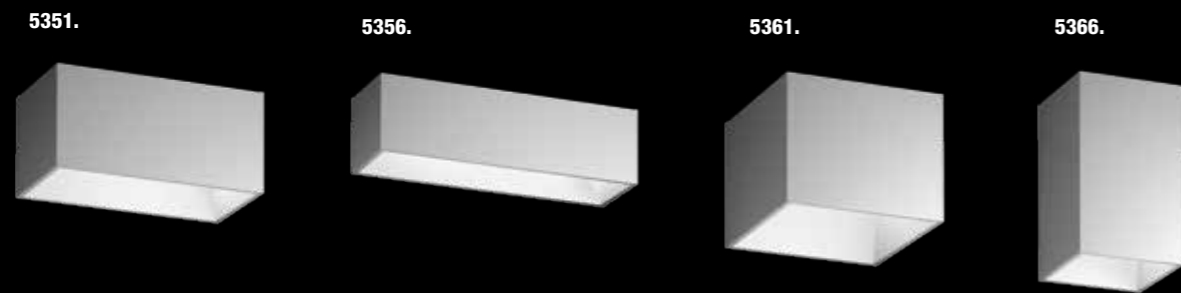

Polycarbonate diffuser / Difusor de policarbonato.

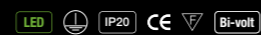

5351 03. 5356 03. 5361 03. 5366 03.
5351 18. 5356 18. 5361 18. 5366 18.

----- 2 x LED STRIP 11,6W 350mA.

- 03 Matt white lacquer / Lacado blanco mate.
- 18 Matt graphite lacquer / Lacado grafito mate.

DALI, 1-10V, Push electronic dimming.
A maximum of 25 modules can be connected to a single connection point.
For bigger compositions, check connection system /
Regulación electrónica a DALI, 1-10V, Pulsador.

A un punto de conexión al techo se puede conectar un máximo de 25 módulos.
Para composiciones superiores, consultar sistema de conexión.

Check additional product specifications at the end of this catalogue: Technical information /
Consultar especificaciones adicionales del producto al final del catálogo: Información Técnica.

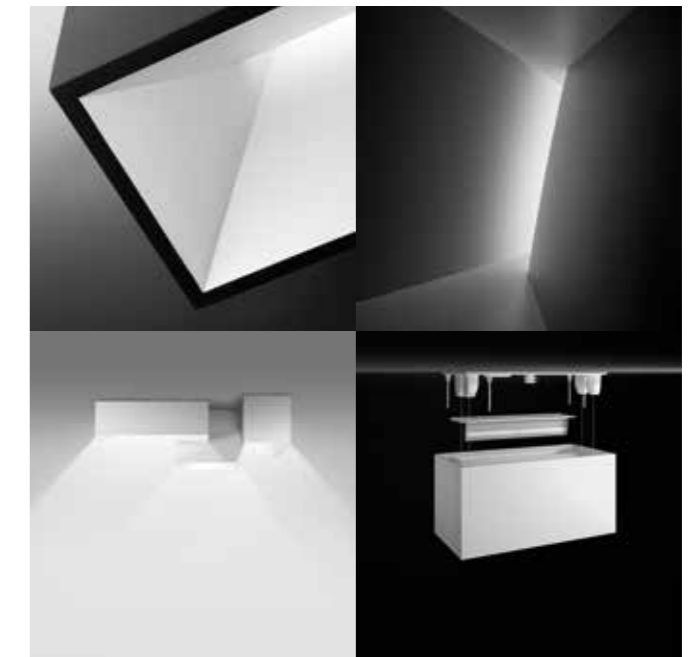

Easy maintenance system /
Fácil sistema de mantenimiento.

Create your product configuration quickly and easily at vibia.com

Go to vibia.com and discover the quickest, most effective way to configure a unique Link XXL design.

Crea tu configuración de producto rápido y fácil en vibia.com

Entra en vibia.com y descubre la manera más rápida y eficiente de configurar un diseño único de Link XXL.



Big

Design by Lievore, Altherr, Molina.



Big breaks new ground in terms of scale and technology, revolutionising the ceiling light fitting.



0530 01.



0530 01.



0530 01. 0530 93.



Easy-to-install and
replace bulb system /
Sistema de fácil instalación
y sustitución de bombillas.

0530. 0532.

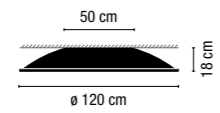

0531. 0533.

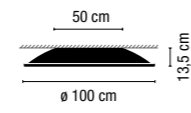

Pages: A-104. B-230/234.

Methacrylate diffuser / Difusor de metacrilato.



Dimmable electronic ballast DALI System and Push / Reactancia electrónica regulable Sistema DALI y Push.	0530 01. 0530 93.	0531 01. 0531 93.	<ul style="list-style-type: none"> 2 X 2G11 230V 36W. 2 X 2G11 230V 24W. 	<ul style="list-style-type: none"> 01 Chrome / Cromo. 93 Matt white lacquer / Lacado blanco mate. 	
	0532 01 /2B. 0532 01 /4B. 0532 93 /2B. 0532 93 /4B.	0533 01 /2B. 0533 01 /4B. 0533 93 /2B. 0533 93 /4B.	<ul style="list-style-type: none"> 4 X LED QUADRANT 16,9W 400MA. 	<ul style="list-style-type: none"> 01 Chrome / Cromo. 93 Matt white lacquer / Lacado blanco mate. 	<p>/2B. 3000 °K. Dimmable: 1-10V + Push.</p> <p>/4B. 4000 °K. Dimmable: 1-10V + Push.</p>

Check additional product specifications at the end of this catalogue: Technical information /
Consultar especificaciones adicionales del producto al final del catálogo: Información Técnica.



0530 01.

Big Built-in

Design by Lievore, Altherr, Molina.



Big breaks new ground in terms of scale and technology, revolutionising the ceiling light fitting.

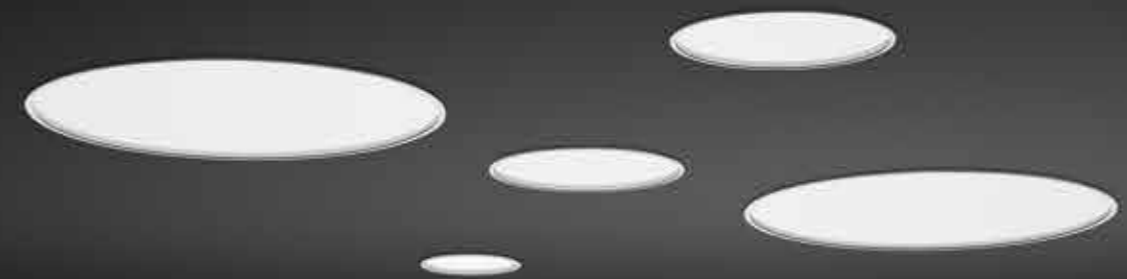

BigBuilt-in

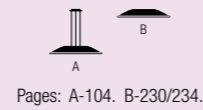
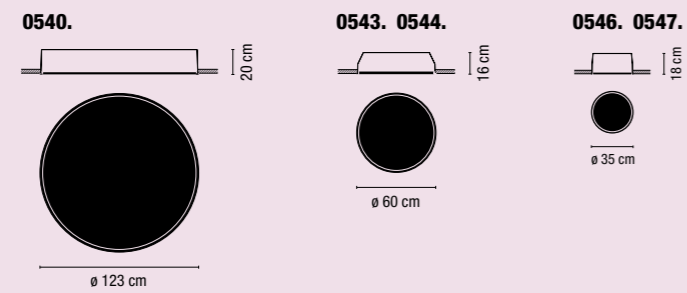

Pages: A-104. B-230/234.

Methacrylate diffuser / Difusor de metacrilato.



Dimmable electronic ballast DALI System and Push / Reactancia electrónica regulable Sistema DALI y Push.	0540 01. 0540 93.	2 x G5 230V 24W (T5) 2 x G5 230V 39W (T5) 2 x G5 230V 54W (T5)	ø 121 cm
	0543 01. 0543 93.	2 x 2G11 230V 24W. 2 x 2G11 230V 36W.	ø 58,7 cm
	0546 01. 0546 93.	1 x 2GX13 230V 55W (T5C).	ø 34 cm
	0544 01. 0544 93.	2 x 2G11 230V 24W. 2 x 2G11 230V 36W.	ø 58,7 cm
	0547 01. 0547 93.	1 x 2GX13 230V 55W (T5C).	ø 34 cm

- 01** Chrome / Cromo.
- 93** Matt white lacquer / Lacado blanco mate.

Built-in / Empotrado.

Check additional product specifications at the end of this catalogue: Technical information /
Consultar especificaciones adicionales del producto al final del catálogo: Información Técnica.



0540 01.



0540 01.

Puck

Design by Jordi Vilardell.



Toy like, a visual game based on mathematical constructs of compositions and intersections. Circles that touch and overlap with one another.

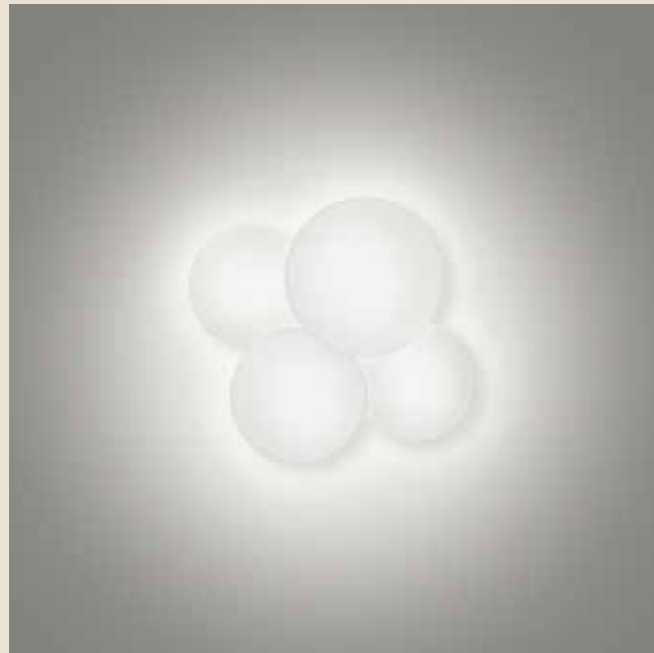

5440 03.



5445 03.

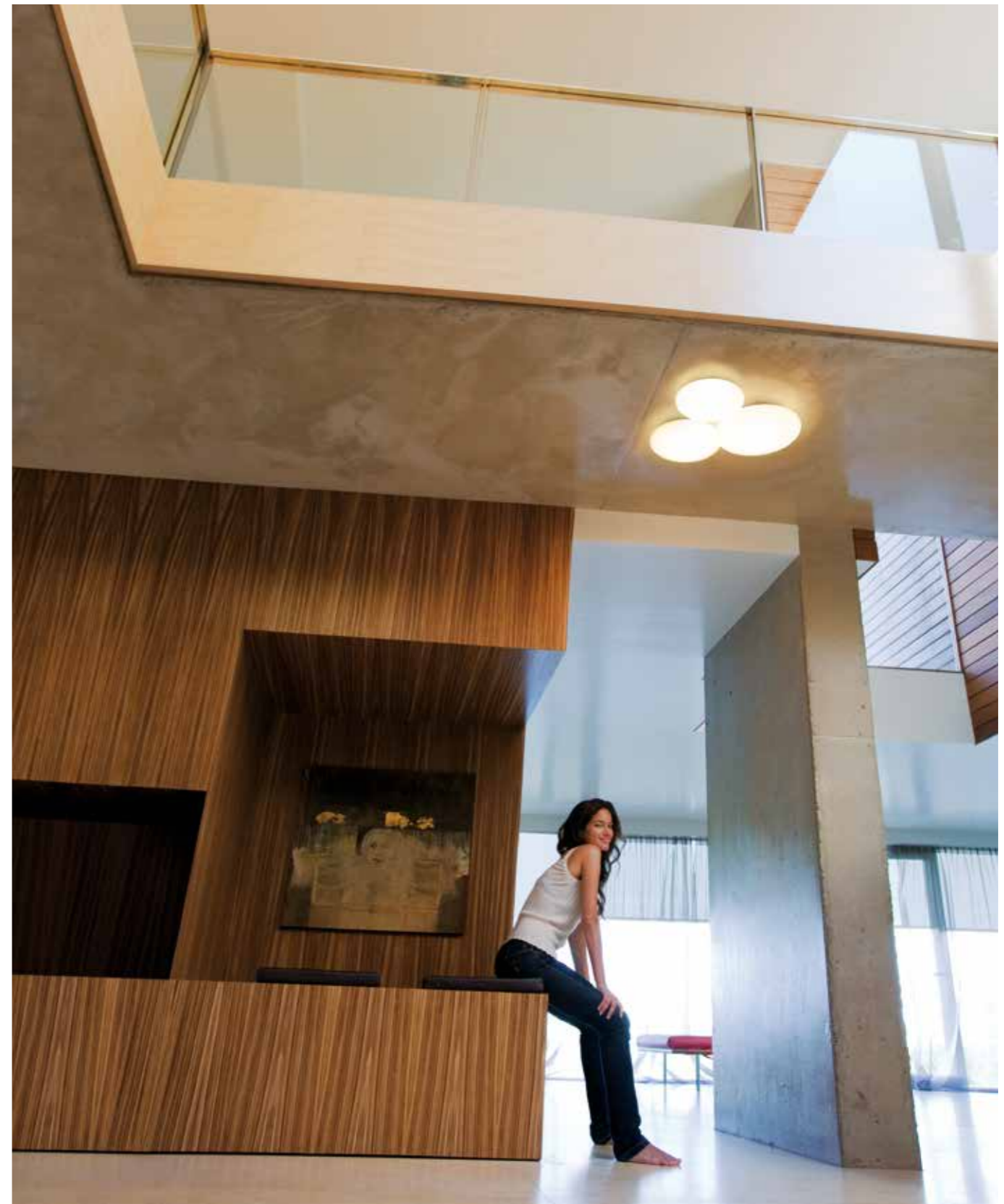

5435 03.

Puck

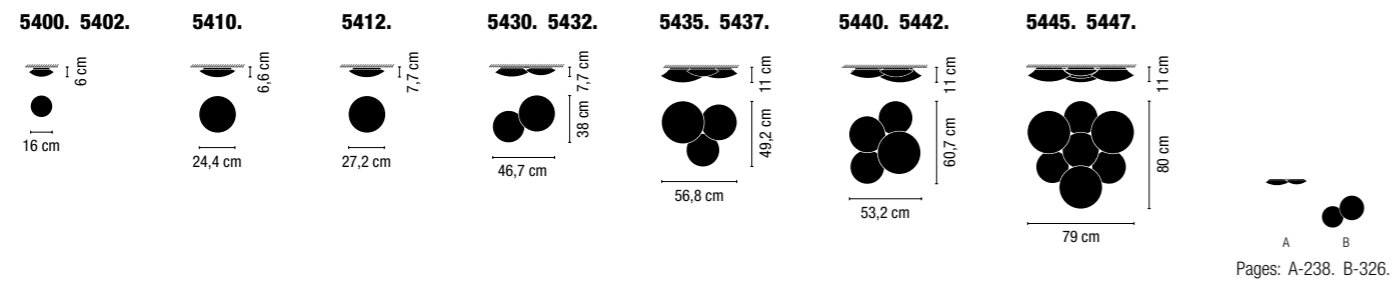
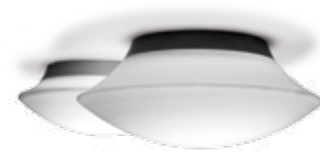

Pages: A-238. B-326.

Matt triplex opal blown glass-diffuser / Difusor de vidrio soplado opal mate triplex.

5400 03.	1 x G9 230V 33W Eco Max.			
5410 03.	1 x G9 230V 48W Eco Max.			
5430 03.	2 x G9 230V 48W Eco Max.			
5435 03.	3 x G9 230V 48W Eco Max.			
5440 03.	4 x G9 230V 48W Eco Max.			
5445 03.	7 x G9 230V 48W Eco Max.			
5402 03 /10.	1 x LED PLATE 3W 350mA.			/10. 2700 °K. Dimmable: No.
5412 03 /10.	1 x LED PLATE 7,35W 350mA.			
5432 03 /10.	2 x LED PLATE 7,35W 350mA.			
5437 03 /10.	3 x LED PLATE 7,35W 350mA.			
5442 03 /10.	4 x LED PLATE 7,35W 350mA.			
5447 03 /10.	7 x LED PLATE 7,35W 350mA.			

All version require only one electrical connection /
 Todas las versiones sólo requieren un punto de conexión eléctrica.
 Check additional product specifications at the end of this catalogue: Technical information /
 Consultar especificaciones adicionales del producto al final del catálogo: Información Técnica.

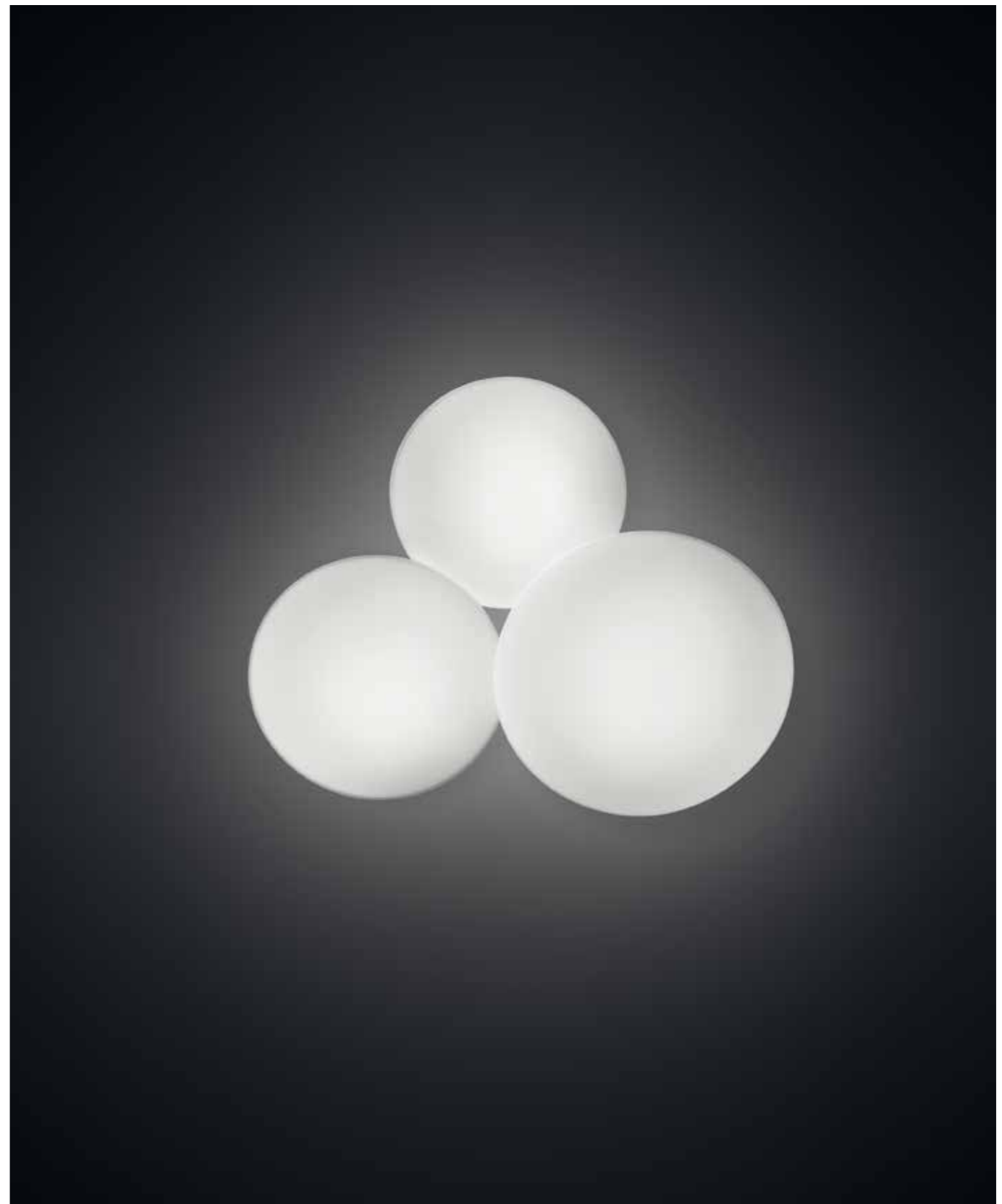

5435 03.

45°

Design by Víctor Carrasco.



A restrained highlight; just the right
accent to integrate the whole.



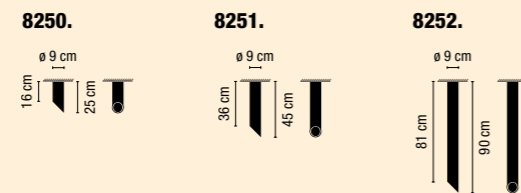

Policarbonate difuser / Difusor de policarbonato.

<p>8250 03 /13. 8250 03 /15. 8250 04 /13. 8250 04 /15. 8250 52 /13. 8250 52 /15.</p>	<p>Ⓢ 1 x LED 6,1W 350mA.</p>	<p>LED Ⓢ IP20 CE ⚡</p>	<p>● 03 Matt white lacquer / Lacado blanco mate. ● 04 Matt black lacquer / Lacado negro mate. ● 52 Satin bronze / Pavonado.</p>	<p>/13. 2700 °K. Dimmable: 1-10V. /15. 2700 °K. Dimmable: Push.</p>
<p>8251 03 /1B. 8252 03 /1B. 8251 04 /1B. 8252 04 /1B. 8251 52 /1B. 8252 52 /1B.</p>	<p>Ⓢ 1 x LED 6,1W 350mA.</p>	<p>LED Ⓢ IP20 CE ⚡ Bi-volt</p>	<p>● 03 Matt white lacquer / Lacado blanco mate. ● 04 Matt black lacquer / Lacado negro mate. ● 52 Satin bronze / Pavonado.</p>	<p>/1B. 2700 °K. Dimmable: 1-10V + Push.</p>

Check additional product specifications at the end of this catalogue: Technical information / Consultar especificaciones adicionales del producto al final del catálogo: Información Técnica.

Changeable diffusers, in orange or matt mink finish / Difusores intercambiables, en acabado visón o anaranjado.



8252 03 /1B. 8251 03 /1B. 8250 03 /13.



8251 03/1B. 8250 03/13.

Adjustable diffuser / Difusor orientable.

45°



8251 04 /1B. 8252 04 /1B. 8251 04 /1B. 8250 04 /13. 8251 03 /1B. 8250 03 /13.

Plus

Design by X. Claramunt & M. de Mas.



Plus is a "skylight" concept for the ceiling, providing a solution for creating a natural daylight atmosphere.

0625 03.



Matt white lacquered finish.
Once the light fitting is installed, to make it fit completely into the architecture it can have the same finish applied as the rest of the ceiling to make it fit completely into the architecture.

Acabado lacado blanco mate.
Una vez instalada la luminaria, y con el fin de aumentar su integración en la arquitectura, se le puede aplicar el mismo acabado de la superficie del techo.



0605 03. 0615 03.

0615 03.



Easy-to-install-
and replace bulb system /
Sistema de fácil instalación y
substitución de bombillas.

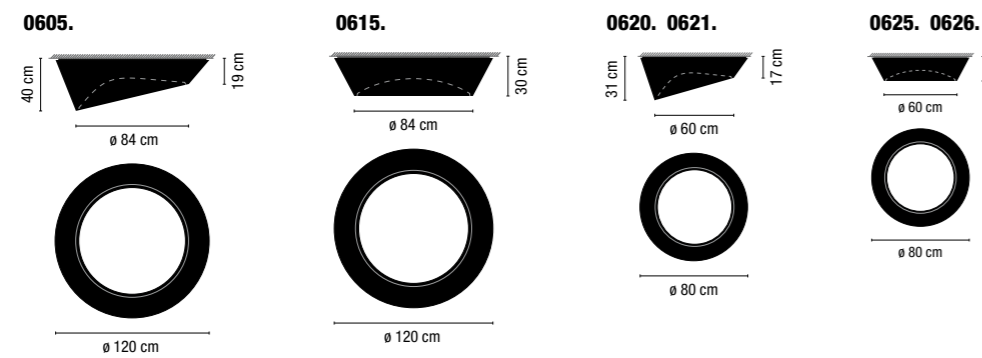

Pages: A-246. B-246 / 392.

Methacrylate diffuser / Difusor de metacrilato.

IP20 CE

Dimmable electronic ballast DALI System and Push / Reactancia electrónica regulable Sistema DALI y Push.	0605 03. 0615 03.	— 2 x G5 230V 24W (T5) — 4 x G5 230V 39W (T5)	● 03 Matt white lacquer / Lacado blanco mate.
	0620 03. 0625 03.	— 4 x G5 230V 24W (T5)	
	0621 03. 0626 03.		

Check additional product specifications at the end of this catalogue: Technical information /
Consultar especificaciones adicionales del producto al final del catálogo: Información Técnica.



0605 03.

Plus



0635 03 0636 03. 0640 03 0641 03. 0630 03 0631 03.

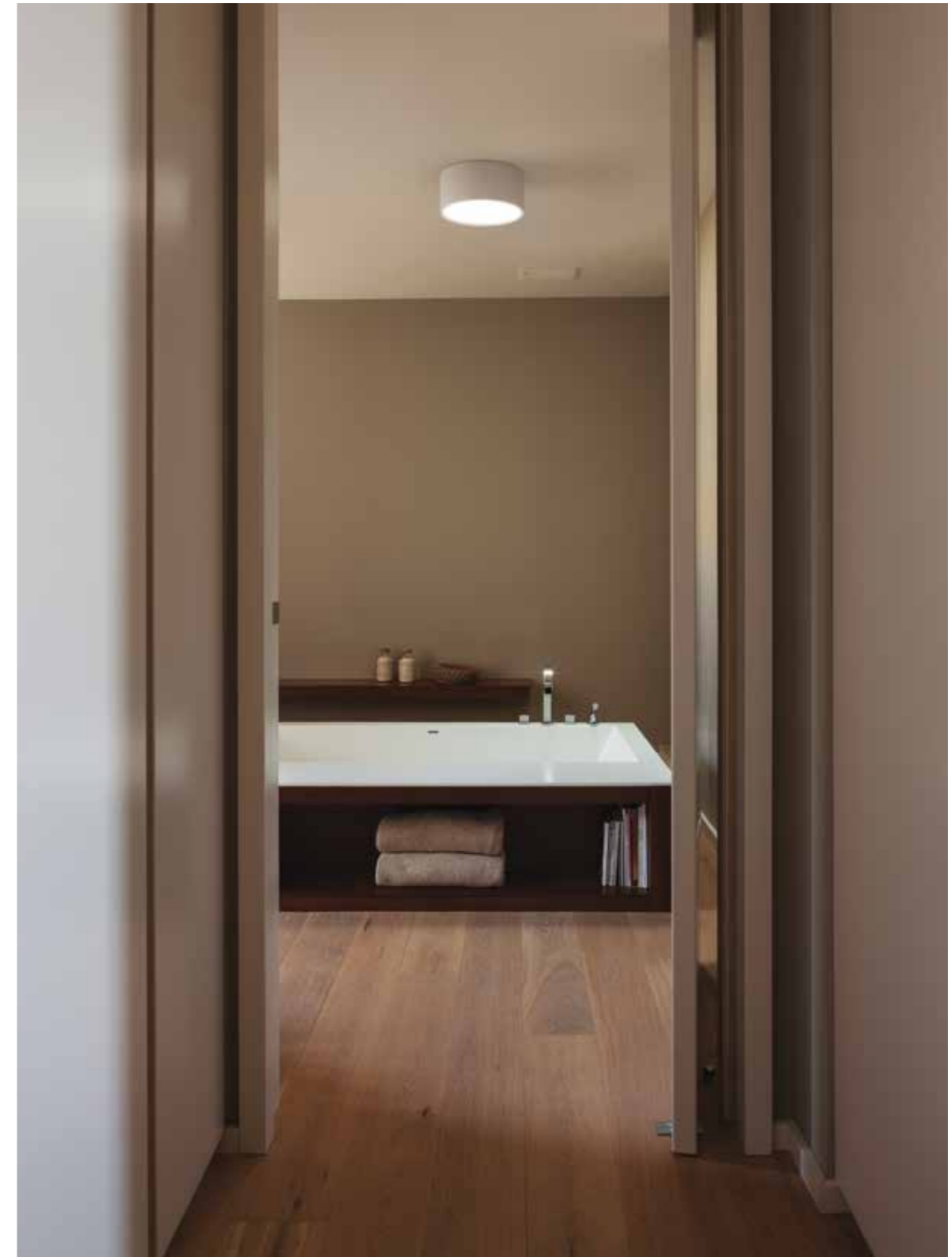

0630 03 0631 03.



0635 03. 0636 03.



0640 03. 0641 03.

0630. 0631.



0635. 0636.

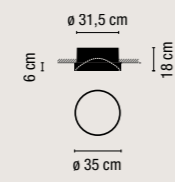

0640. 0641.

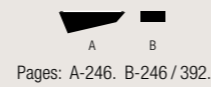
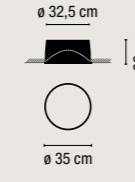

Pages: A-246. B-246 / 392.

Methacrylate / Difusor de metacrilato.

Dimmable version: electronic ballast (DALI System / dimmer switch) / Versión regulable: reactancia electrónica (Sistema DALI / pulsador).	Surface fitting / Superficie	0630 03.				 1 x 2GX13 230V 55W (T5C). 03 Matt white lacquer / Lacado blanco mate.
	Semi built-in / Semi empotrado	0635 03.			 ø 32,8 cm	
	Built-in / Empotrado	0640 03.			 ø 34,2 cm	
Surface fitting / Superficie	0631 03.					
Semi built-in / Semi empotrado	0636 03.			 ø 32,8 cm		
Built-in / Empotrado	0641 03.			 ø 34,2 cm		

Check additional product specifications at the end of this catalogue: Technical information /
Consultar especificaciones adicionales del producto al final del catálogo: Información Técnica.



0630 03. 0631 03.

Domo

Design by Ramos & Bassols.



Accent lighting provided by a visible object integrated within the architecture of the space in an unobtrusive fashion that is restrained but forceful, attractive and functionally precise.

8200.



8201.



8205.



8206.



8200 03 /12. 8211 08 /12. 8210 07 /12.



8200 03 /12.



8206 03 /12.



8200 03 /12.

8200. 8210. 8211.

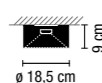

8201.

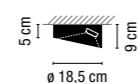

8205.

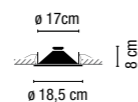

8206.

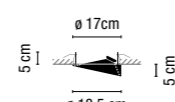

Aluminum diffuser / Difusor de aluminio.

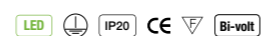

Surface fitting / Superficie	8200 03 /12. 8201 03 /12.	● 03 Matt white lacquer / Lacado blanco mate.	Ⓢ 3 x LED 2,1W 700mA.	/12. 2700 °K. Dimmable: 0-10V.
	8210 03 /12. 8210 07 /12. 8210 08 /12.	<ul style="list-style-type: none"> ● 03 Outside: Matt graphite lacquer. Inside: matt white lacquer / Exterior: lacado grafito mate. Interior: lacado blanco mate. ● 07 Outside: Matt graphite lacquer. Inside: matt green lacquer / Exterior: lacado grafito mate. Interior: lacado verde mate. ● 08 Outside: Matt graphite lacquer. Inside: matt orange lacquer / Exterior: lacado grafito mate. Interior: lacado naranja mate. 		
	8211 07 /12. 8211 08 /12.	<ul style="list-style-type: none"> ● 07 Outside: matt white lacquer. Inside: matt green lacquer / Exterior: lacado blanco mate. Interior: lacado verde mate. ● 08 Outside: matt white lacquer. Inside: matt orange lacquer / Exterior: lacado blanco mate. Interior: lacado naranja mate. 		
Built-in / Empotrado	8205 03 /12. 8206 03 /12.	 <ul style="list-style-type: none"> ● 03 Matt white lacquer / Lacado blanco mate. 		

Check additional product specifications at the end of this catalogue: Technical information /
Consultar especificaciones adicionales del producto al final del catálogo: Información Técnica.

Domo

The symmetrical version of Domo is suitable for lighting transit areas such as corridors, entrance halls and the like, in which constant repetition of the light fitting is necessary to guide traffic through them.

La versión simétrica de Domo es adecuada para iluminar zonas de paso como pasillos, recibidores... en las que es necesaria la repetición continuada de la luminaria para orientar el paso y la circulación.



8200. 8210. 8211.
Surface fitting / Superficie.

8205.
Built-in / Empotrado.



Domo - Adjustable light

The adjustable version allows a rotation of 180° to direct the light at the features you wish to highlight. Surface mounted or built into the ceiling, this model allows you to bathe walls or to light pictures, sculptures or dressing rooms, blending into the architecture of any kind of room.

Domo - Luz orientable

La versión orientable permite girar la pieza 180° y dirigir la luz hacia aquellos elementos que queremos acentuar. Instalada en superficie o empotrada en el techo, este modelo permite bañar paredes, iluminar cuadros, esculturas, vestidores... integrándose en la arquitectura de cualquier tipo de espacio.

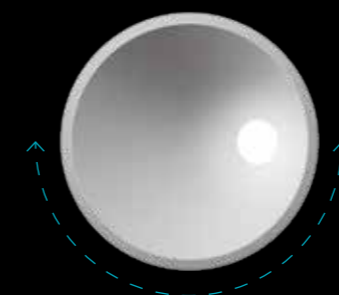

8201.
Surface fitting / Superficie.

8206.
Built-in / Empotrado.





Funnel



Material, light and space integrated within a light fitting.
The perfect equation for an unsurpassable result.



2004 03.

Funnel

© The Original

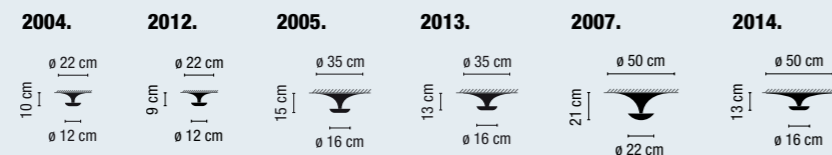

Pages: A-258, B-334.

Aluminum diffuser / Difusor de aluminio.

Mini. ø 22 cm	2004 01. 2004 03. 2004 04. 2004 06.	2 x G9 230V 60W Eco Max.	IP20 CE Bi-volt	<ul style="list-style-type: none"> 01 Chrome / Cromo. 03 Gloss white lacquer / Lacado blanco brillo. 04 Black lacquer / Lacado negro. 06 Red lacquer / Lacado rojo. 	
	2012 51 /10. 2012 93 /10.	1 x LED PLATE 6,3W 350mA.	LED IP20 CE Bi-volt	<ul style="list-style-type: none"> 51 Matt gold leaf / Pan de oro mate. 93 Matt white lacquer / Lacado blanco mate. 	/10. 2700 °K. Dimmable: No.
ø 35 cm	2005 03.	3 x G9 230V 48W Eco Max.	IP20 CE Bi-volt	<ul style="list-style-type: none"> 03 Gloss white lacquer / Lacado blanco brillo. 	
	2013 51 /1A. 2013 93 /1A.	6 x LED 4,5W 350mA.	LED IP20 CE Bi-volt	<ul style="list-style-type: none"> 51 Matt gold leaf / Pan de oro mate. 93 Matt white lacquer / Lacado blanco mate. 	/1A. 2700 °K. Dimmable: 1-10V + DALI + Push.
ø 50 cm	2014 93 /1A.	6 x LED 4,5W 350mA.	LED IP20 CE Bi-volt	<ul style="list-style-type: none"> 93 Matt white lacquer / Lacado blanco mate. 	
	2007 03.	3 x R7s 80mm 230V 80W Eco.	IP20 CE Bi-volt	<ul style="list-style-type: none"> 03 Gloss white lacquer / Lacado blanco brillo. 	

Check additional product specifications at the end of this catalogue: Technical information /
Consultar especificaciones adicionales del producto al final del catálogo: Información Técnica.



2012 93 /10. 2013 93 /1A.

0962 01.



Scotch

Design by Oscar & Sergi Devesa.



Rounded transparent glass featuring a very soft and pleasing profile, almost imperceptible.



Scotch

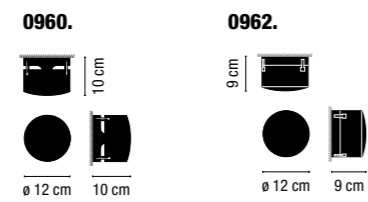

Pages: 262 / 330 / 400.

Pressed-glass diffuser / Difusor de vidrio prensado.

0960 01.	1 x G9 230V 33W Eco Max.	IP20 CE Bi-volt	01 Chrome / Cromo.	
0962 01 /10.	1 x LED PLATE 3W 350mA.	LED IP65 CE Bi-volt	01 Chrome / Cromo.	/10. 2700 °K. Dimmable: No.

Check additional product specifications at the end of this catalogue: Technical information / Consultar especificaciones adicionales del producto al final del catálogo: Información Técnica.



0960-01.

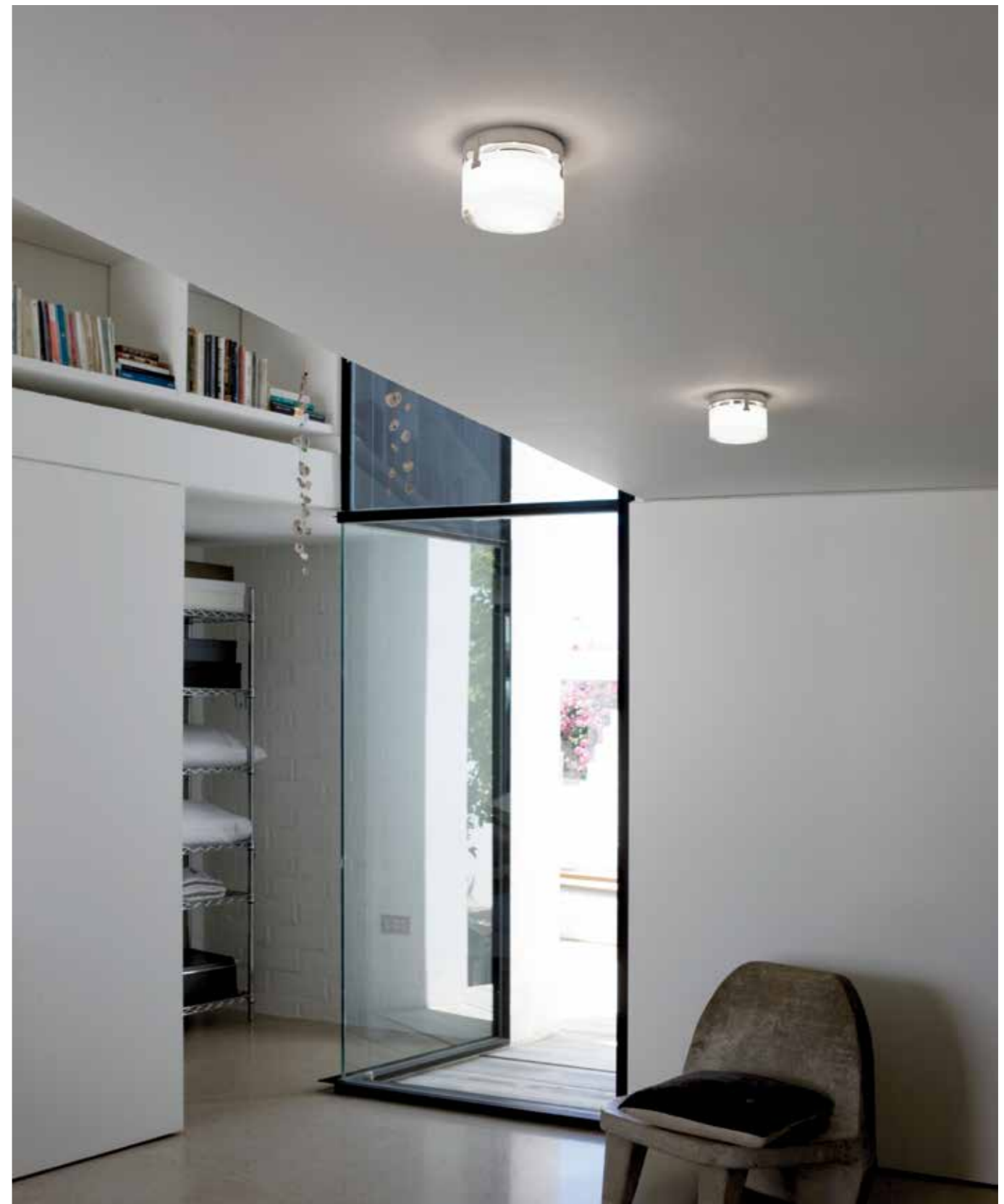

0960 01.



Stage

Design by X. Claramunt and M. de Mas.

An elongated cylindrical directional spot light.

8982 03.



8960 18 /10.



8962.

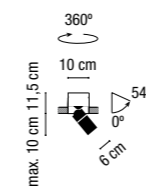

8972.

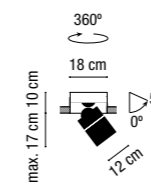

8982.

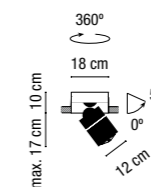

8960.

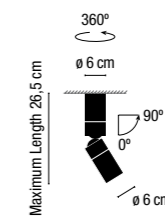

8970. 8980.

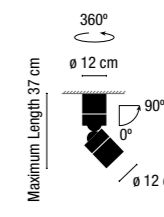

Built-in / Empotrado.	8962 03 /10. 8962 18 /10.	1 x LED 10,2W 550mA.	LED IP20 CE Bi-volt	03 Matt white lacquer / Lacado blanco mate. 18 Matt graphite lacquer / Lacado grafito mate.	/10. 2700 °K. Dimmable: No.
	8972 03. 8972 18.	1 x PAR 30 E27 230V 100W Max.	IP20 CE Bi-volt	03 Matt white lacquer / Lacado blanco mate. 18 Matt graphite lacquer / Lacado grafito mate.	
	8982 03. 8982 18.	1 x QR111 12V 60W ALU 24° (REFLECTOR WITHOUT GLASS) MAX. OR 1 x MASTER LEDspotLV AR111 D 15-75W WH 24D.	IP20 CE Bi-volt	03 Matt white lacquer / Lacado blanco mate. 18 Matt graphite lacquer / Lacado grafito mate.	
Surface wfitting / Superficie.	8960 03 /10. 8960 18 /10.	1 x LED 10,2W 550mA.	LED IP20 CE Bi-volt	03 Matt white lacquer / Lacado blanco mate. 18 Matt graphite lacquer / Lacado grafito mate.	/10. 2700 °K. Dimmable: No.
	8970 03. 8970 18.	1 x PAR 30 E27 230V 100W Max.	IP20 CE Bi-volt	03 Matt white lacquer / Lacado blanco mate. 18 Matt graphite lacquer / Lacado grafito mate.	
	8980 03. 8980 18.	1 x QR111 12V 60W ALU 24° (REFLECTOR WITHOUT GLASS) MAX. OR 1 x MASTER LEDspotLV AR111 D 15-75W WH 24D.	IP20 CE	03 Matt white lacquer / Lacado blanco mate. 18 Matt graphite lacquer / Lacado grafito mate.	

Check additional product specifications at the end of this catalogue: Technical information /
Consultar especificaciones adicionales del producto al final del catálogo: Información Técnica.

Quadra Ice

Classic and timeless silhouette.
Minimal presence. Integrates readily.

© The Original

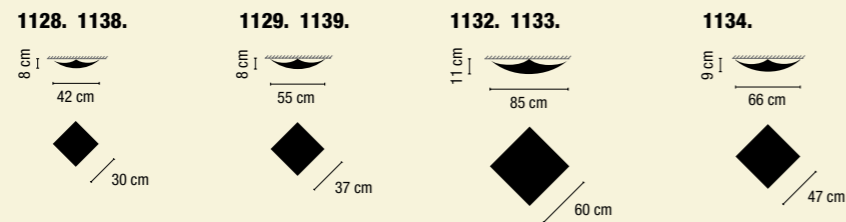

Optical glass diffuser / Difusor de vidrio óptico.

1128 00.	1 x R7s 80mm 230V 120W Eco Max.		00 White glass / Vidrio blanco.	
1129 00. 1133 00. 1134 00.	1 x R7s 117mm 230V 230W Eco Max.			
1132 00.	<ul style="list-style-type: none"> 1 x 2GX13 230V 22W (T5C). 1 x 2GX13 230V 40W (T5C). 			
1138 00 /1B.	1 x LED PLATE 16,5W 500mA.		00 White glass / Vidrio blanco.	/1B. 2700 °K. Dimmable: 1-10V + PUSH.
1139 00 /1B.	1 x LED PLATE 23,1W 700mA.			

Check additional product specifications at the end of this catalogue: Technical information /
Consultar especificaciones adicionales del producto al final del catálogo: Información Técnica.

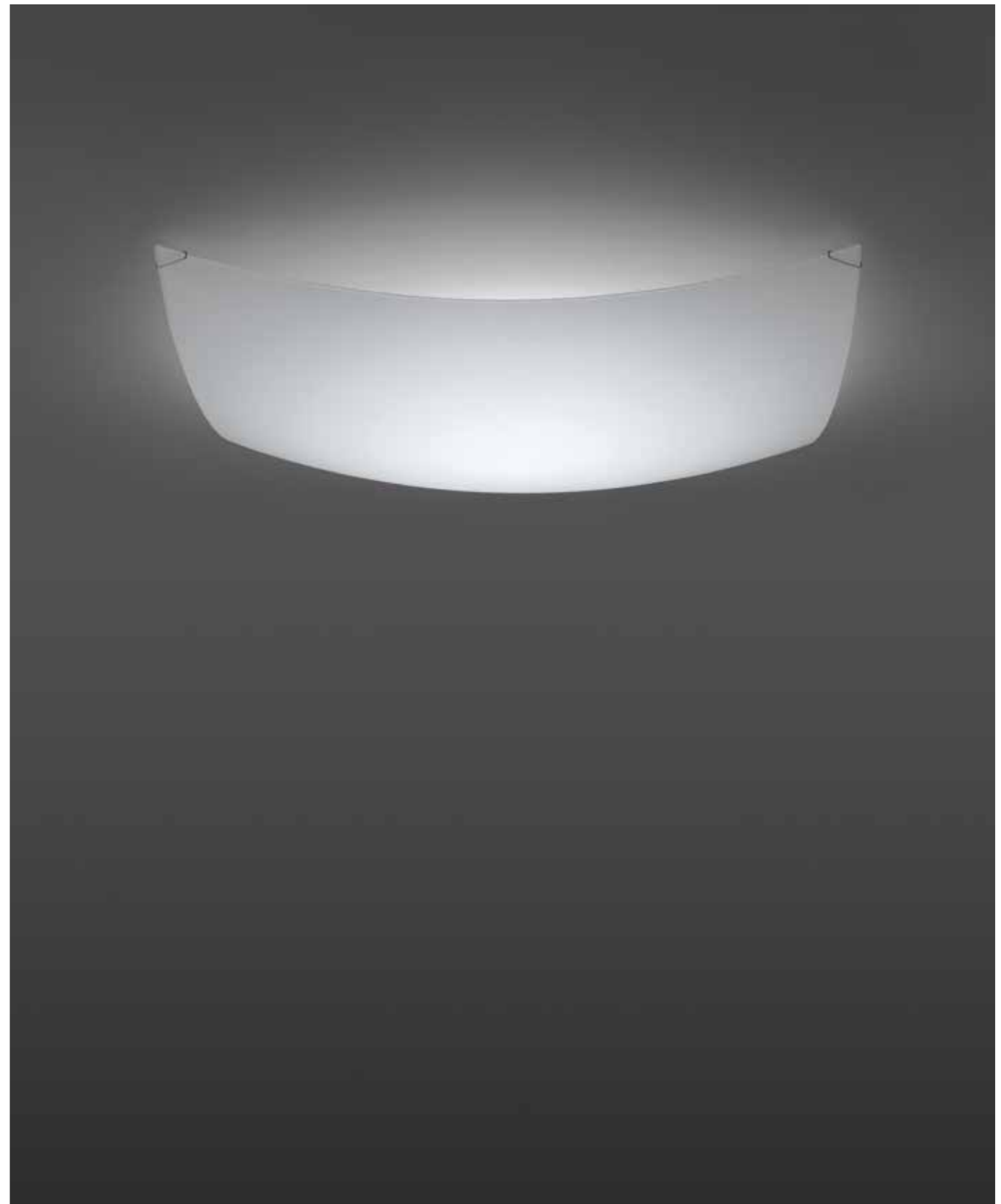

1132 00.

Wall

Wall Arts,
Reading Intimacy,
Pattern Generation,
Light & Shadows Compositions...



Wall Arts

Walls are the best canvas and light a luminous palette with which to draw, paint and sculpt its vertical planes.



Reading Intimacy

The pleasure of enjoying the intimacy of a good read under an inspirational light.



Light & Shadows

Compositions

Artificial light sources allow us to set time. Define and control shadows, at times becoming an extension of the product's lighting effect at others reminders of the natural world brought indoors.



Pattern Generation

Patterns and rhythm generated from product compositions and their visual effects, shadows, reflection, tones, textures, subtleties....

Wall



Alpha
pag. 308



Micro
pag. 298



Milenium
pag. 342



North
pag. 272



Centric
pag. 316



FoldSurface
pag. 320



FoldBuilt-in
pag. 324



Funnel
pag. 334



I.Cono
pag. 302

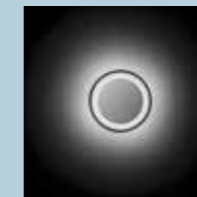

Micro
pag. 298



Milenium
pag. 342



North
pag. 272

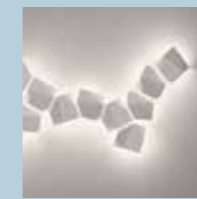

Origami
pag. 288



Pin
pag. 282



Puck Wall Art
pag. 304



Set
pag. 276



Puck
pag. 326

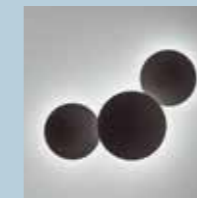

Puck Wall Art
pag. 304

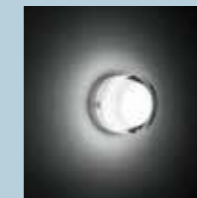

Scotch
pag. 330



Set
pag. 276

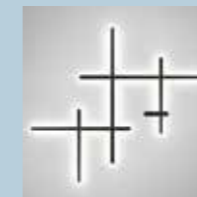

Sparks
pag. 346



Suite
pag. 293



Swing
pag. 338



Set
pag. 276

North

Design by Arik Levy.



North, south, east and west are our points of references in space;
we set-out, build and travel according to these coordinates.



5630 04 /15.



5635 04 /15.

5630.

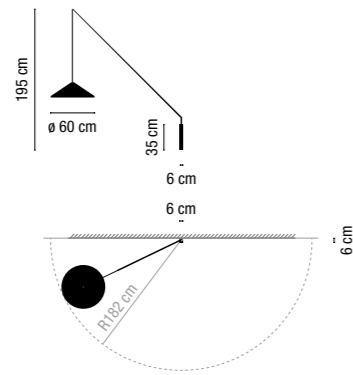

5635.

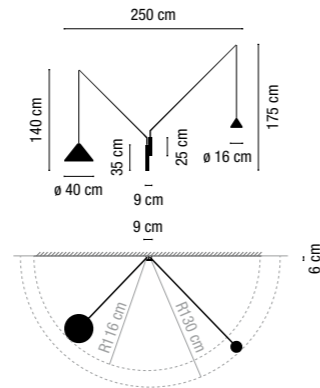

5640.

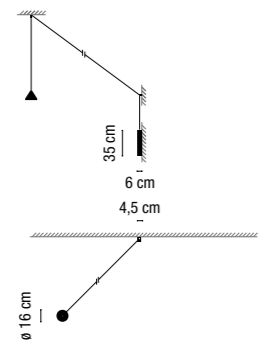

5642.

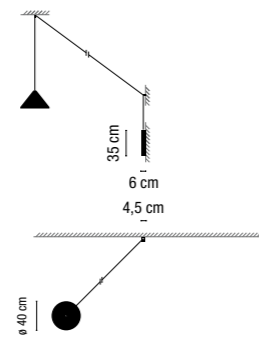

5644.

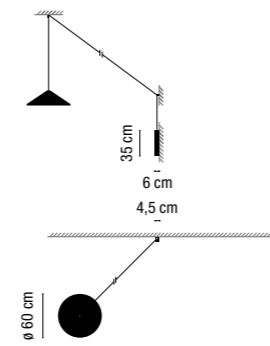

Adjustable installation: 10 m wire and 2 pegs included /
Instalación ajustable: incluye 10 m de cable y 2 mordazas.

Aluminum shade / Pantalla de aluminio.

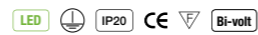

5630 04 /15. 5630 05 /15. 5630 58 /15. 5630 93 /15.	1 x LED 9W 350mA.	<ul style="list-style-type: none"> ● 04 Matt graphite lacquer / Lacado grafito mate. ● 05 Matt blue lacquer / Lacado azul mate. ● 58 Matt cream lacquer / Lacado crema mate. ● 93 Matt white lacquer / Lacado blanco mate. 	/15. 2700 °K. Dimmable: Push.
5635 04 /15. 5635 05 /15. 5635 58 /15. 5635 93 /15.	2 x LED 9W 350mA.		
5640 04 /15. 5640 05 /15. 5640 58 /15. 5640 93 /15.	1 x LED 9W 350mA.		
5642 04 /15. 5642 05 /15. 5642 58 /15. 5642 93 /15.			
5644 04 /15. 5644 05 /15. 5644 58 /15. 5644 93 /15.			

Check additional product specifications at the end of this catalogue: Technical information /
Consultar especificaciones adicionales del producto al final del catálogo: Información Técnica.

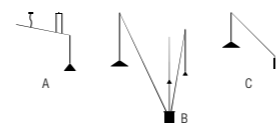

Pages: A-86. B-136. C-272.



5630 05 /15.



5630 05 /15.



5640 05 /15.

Set

Design by Xuclà.



A game of light and shade, reflections and spatial effects.
A sculptural wall-installation.

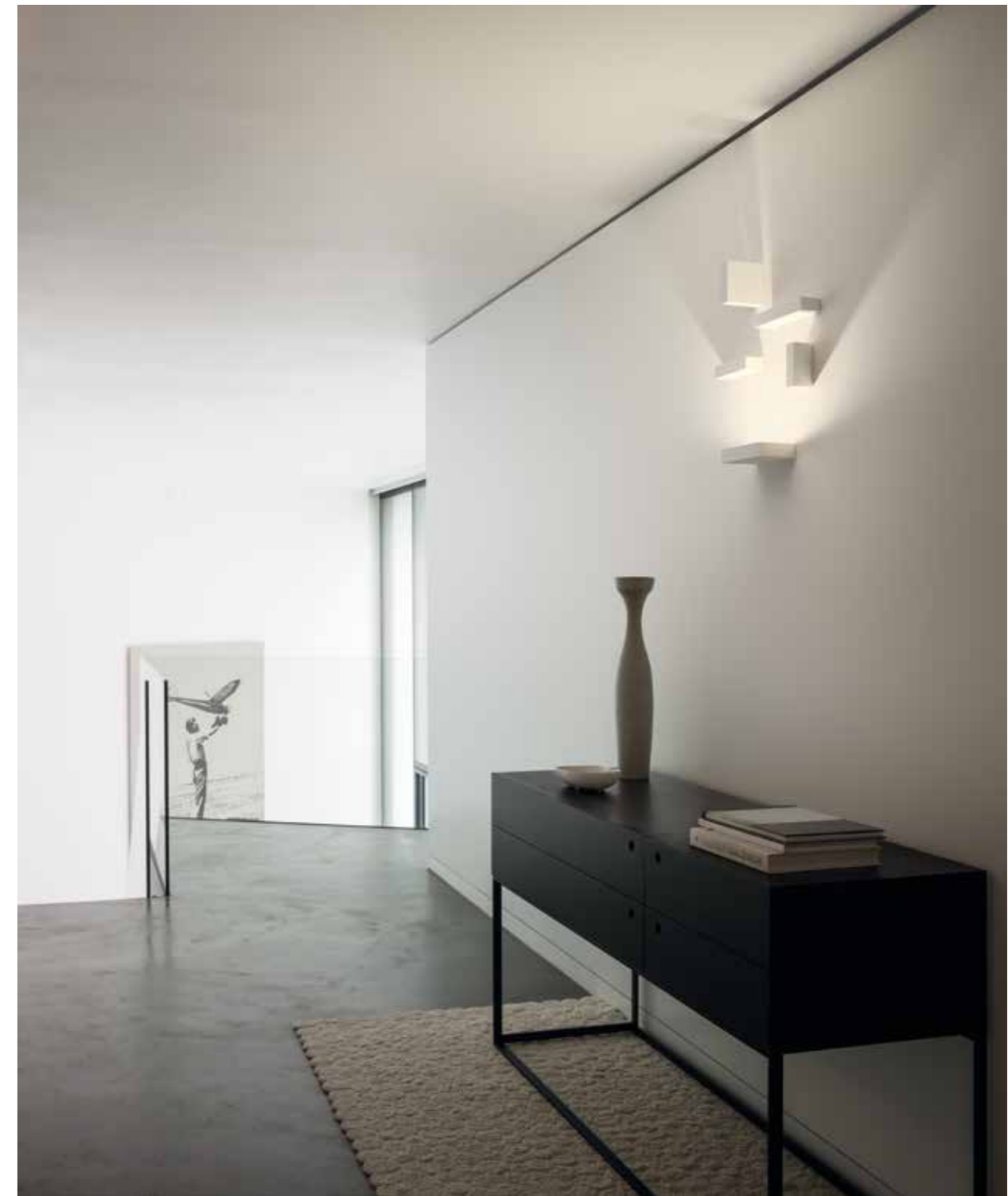

7753 93 /12.

Set

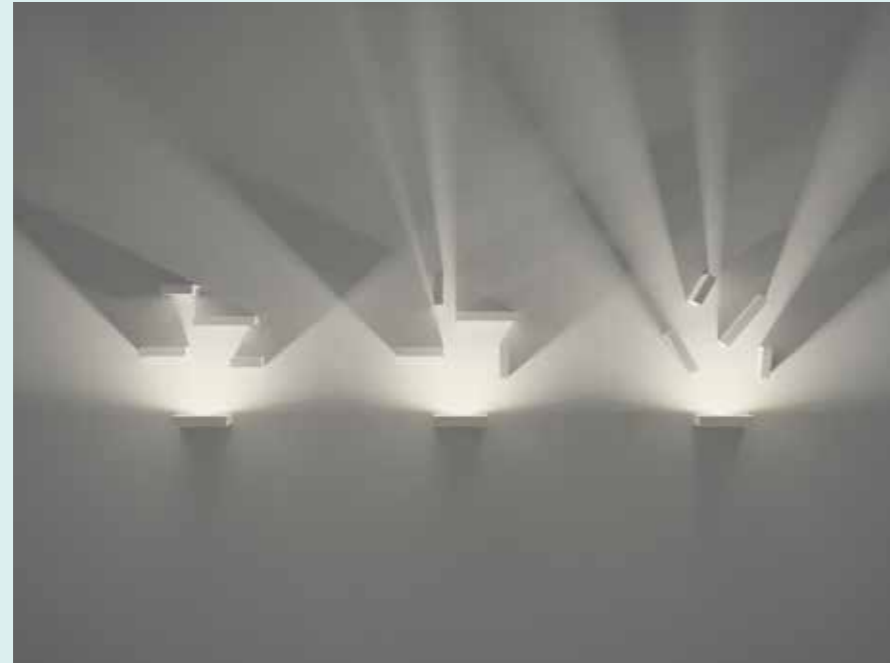

The upper reflectors that are not equipped with LED can be oriented as desired to affect the direction and pattern of light and shadows across the wall.

Los reflectores superiores que no están dotados de led pueden orientarse según se desee, afectando a la gráfica del mural en la pared.



Create your product configuration quickly and easily at vibia.com

Go to vibia.com and discover the quickest, most efficient way to configure a unique lighting mural with Set.

Crea tu configuración de producto rápido y fácil en vibia.com

Entra en vibia.com y descubre la manera más rápida y eficiente de configurar un mural lumínico único con Set.

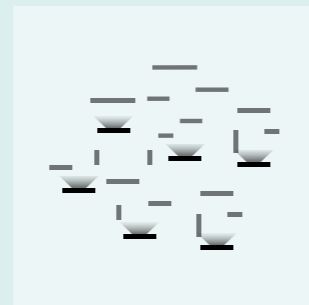
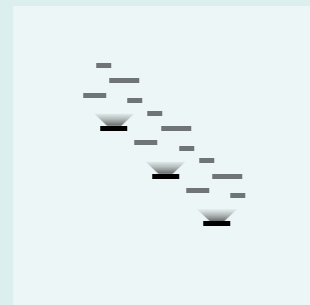
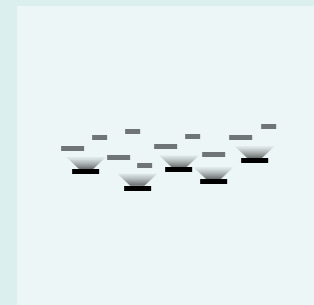

Set

Small / Pequeñas

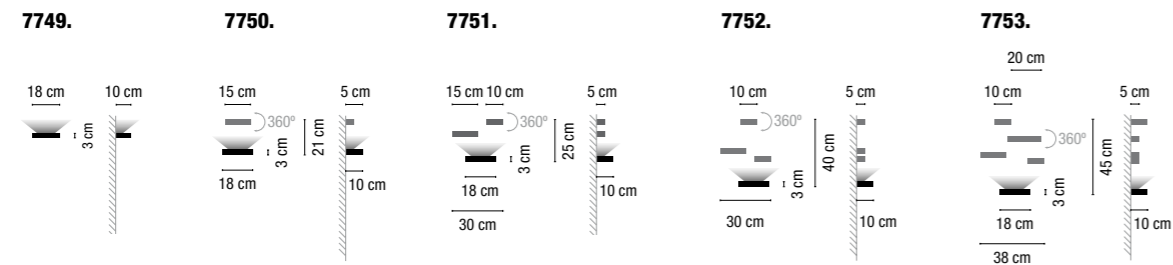

Big / Grandes

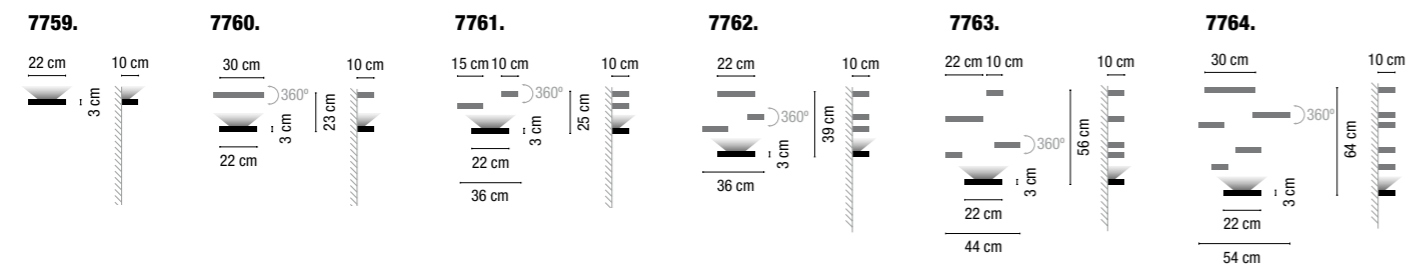

Borosilicate glass diffuser / Difusor de vidrio de borosilicato.



Small / Pequeñas.	7749 59 /12. 7749 93 /12. 7750 59 /12. 7750 93 /12. 7751 59 /12. 7751 93 /12. 7752 59 /12. 7752 93 /12. 7753 59 /12. 7753 93 /12.	1 x LED 9W 350mA.	<ul style="list-style-type: none"> ● 59 Matt mink lacquer / Lacado visón mate. ● 93 Matt white lacquer / Lacado blanco mate. 	/12. 2700 °K. Dimmable: 0-10V.
Big / Grandes.	7759 59 /12. 7759 93 /12. 7760 59 /12. 7760 93 /12. 7761 59 /12. 7761 93 /12. 7762 59 /12. 7762 93 /12. 7763 59 /12. 7763 93 /12. 7764 59 /12. 7764 93 /12.	1 x LED 9W 350mA.		

LED placed on the lower element / LED situado en la pieza inferior de cada referencia.
 Check additional product specifications at the end of this catalogue: Technical information /
 Consultar especificaciones adicionales del producto al final del catálogo: Información Técnica.

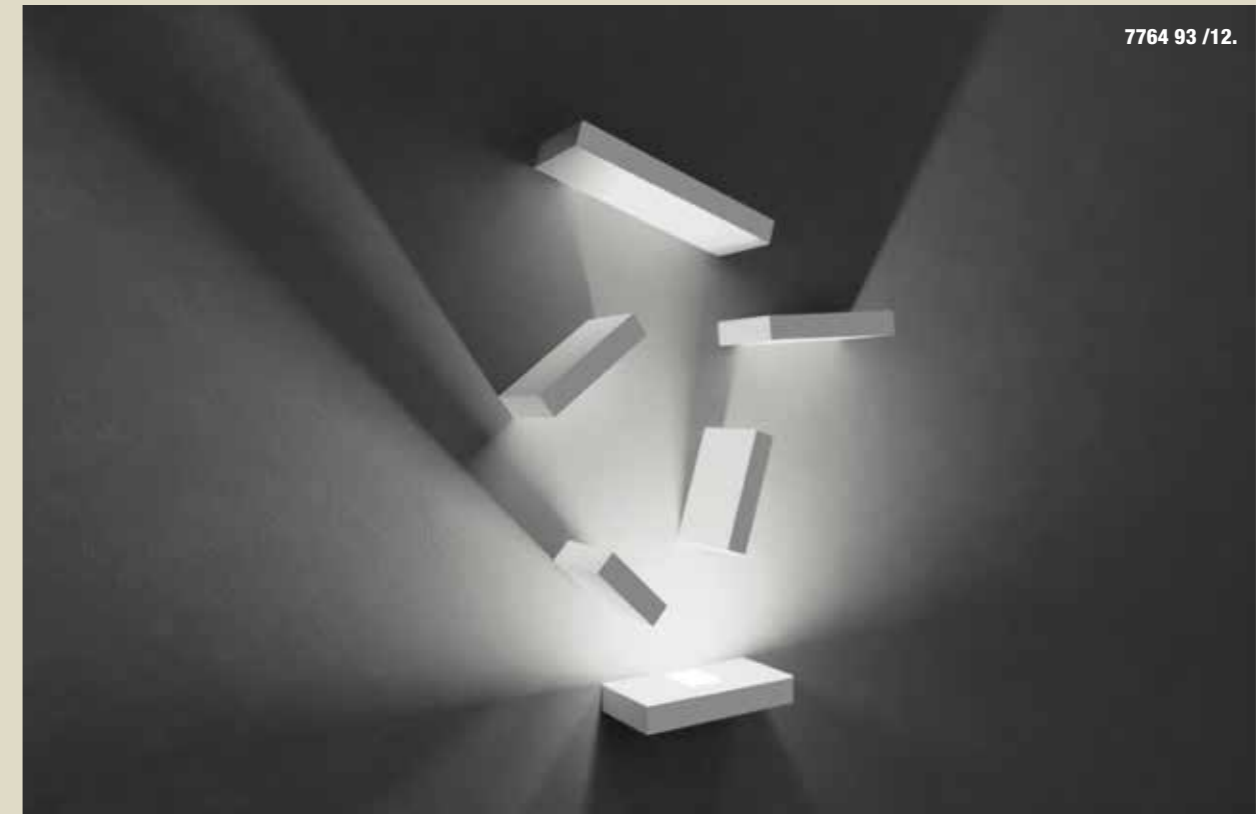

Only the lower unit of each array contains an LED, which projects light on to the reflectors.

Sólo la pieza inferior de cada referencia contiene un led, cuya luz se proyecta en el resto de piezas superiores.



7750 93 /12.

Pin

Design by Ichiro Iwasaki.



Through the exploration of "eternal comfort" in lighting environments PIN aims to provide something new and original yet in harmony with both the old and the contemporary.



1690 93 /10. 1692 93 /10. 1694 93 /10.



1690 04 /10. 1692 04 /10. 1694 04 /10.

Pin



1680 04 /10. 1685 04 /10.



1680 04 /10.

Pin

1675.



1680.

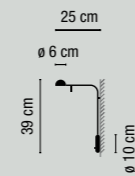

1685.

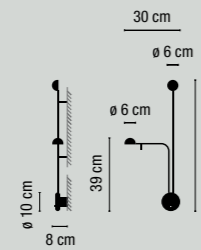

1686.

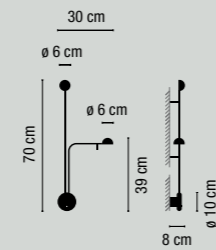

1690.

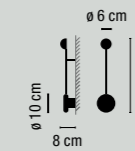

1692.

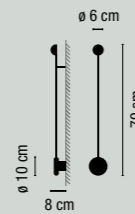

1694.

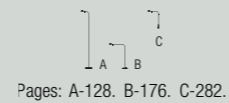
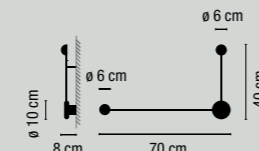

Pages: A-128. B-176. C-282.

Polycarbonate diffuser / Difusor de policarbonato.



<p>1675 04 /10. 1680 04 /10. 1675 58 /10. 1680 58 /10. 1675 62 /10. 1680 62 /10. 1675 93 /10. 1680 93 /10.</p>	<p>1 x LED 4,5W 350mA.</p>	<p>● 04 Matt black lacquer / Lacado negro mate. ● 58 Matt cream lacquer / Lacado crema mate. ● 62 Matt green lacquer / Lacado verde mate. ● 93 Matt white lacquer / Lacado blanco mate.</p>	<p>/10. 2700 °K. Dimmable: No.</p>
<p>1685 04 /10. 1686 04 /10. 1685 58 /10. 1686 58 /10. 1685 62 /10. 1686 62 /10. 1685 93 /10. 1686 93 /10.</p>	<p>2 x LED 4,5W 350mA.</p>		
<p>1690 04 /10. 1692 04 /10. 1690 58 /10. 1692 58 /10. 1690 62 /10. 1692 62 /10. 1690 93 /10. 1692 93 /10.</p>	<p>1 x LED 4,5W 350mA.</p>		
<p>1694 04 /10. 1694 58 /10. 1694 62 /10. 1694 93 /10.</p>	<p>2 x LED 4,5W 350mA.</p>		

Check additional product specifications at the end of this catalogue: Technical information / Consultar especificaciones adicionales del producto al final del catálogo: Información Técnica.

1675 04 /10.

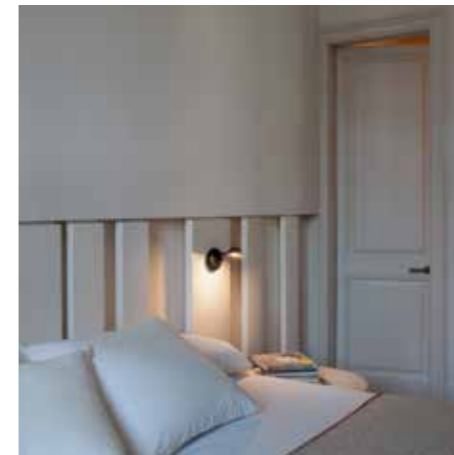

1675 04 /10.



1675 62 /10. 1675 58 /10. 1675 93 /10.

Origami

Design by Ramón Esteve.



Origami blends light functionality with an opportunity for artistic creation. A fitting inspired by Origami, featuring the folds of the eponymous Japanese art-form.

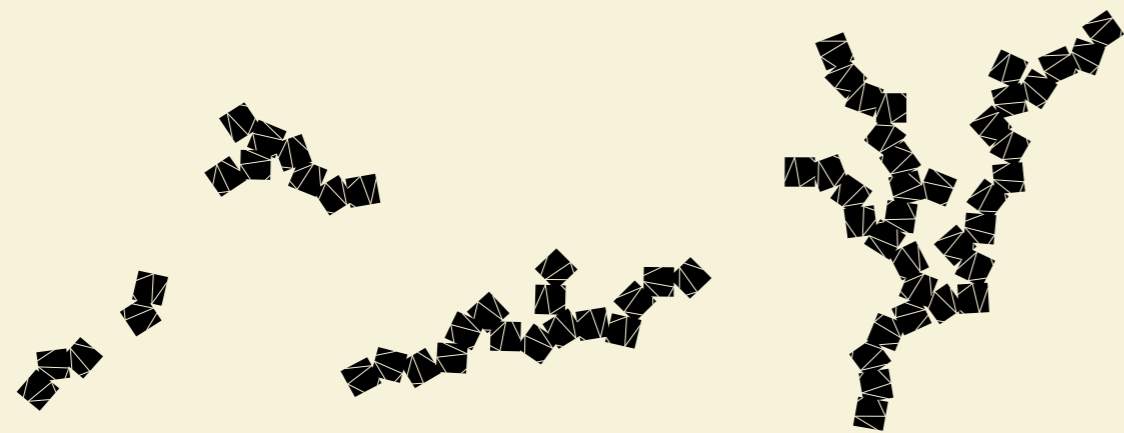

Create your product configuration quickly and easily at vibia.com

Go to vibia.com and discover the quickest, most efficient way to configure a unique lighting mural with Origami.

Crea tu configuración de producto rápido y fácil en vibia.com

Entra en vibia.com y descubre la manera más rápida y eficiente de configurar un mural luminoso único con Origami.

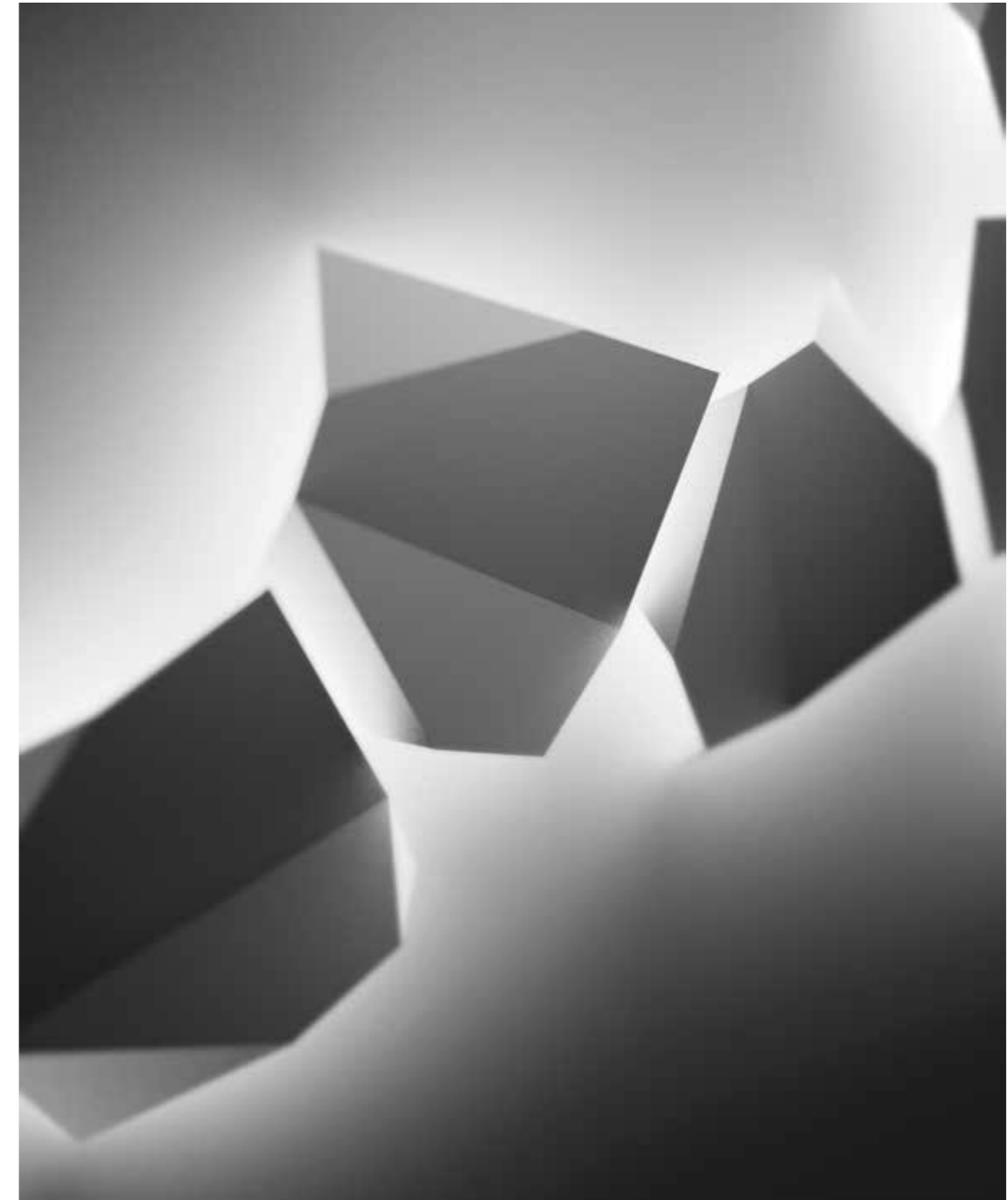

Origami

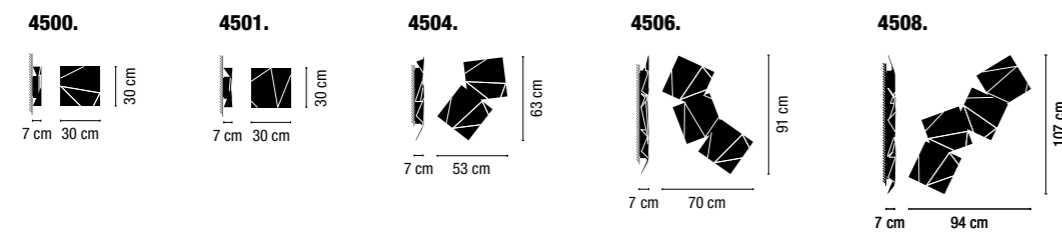

Pages: 288 / 410.

Policarbonate diffuser / Difusor de policarbonato.



4500 03 /14. 4501 03 /14. 4500 07 /14. 4501 07 /14. 4500 54 /14. 4501 54 /14.	 1 x LED STRIP 6,5W 350mA.	<ul style="list-style-type: none"> 03 Matt white lacquer / Lacado blanco mate. 07 Green oxide lacquer / Lacado verde óxido. 54 Oxide lacquer / Lacado óxido. 	/14. 2700 °K. Dimmable: TRIAC.
4504 03 /14. 4504 07 /14. 4504 54 /14.	 2 x LED STRIP 6,5W 350mA.		
4506 03 /14. 4506 07 /14. 4506 54 /14.	 3 x LED STRIP 6,5W 350mA.		
4508 03 /14. 4508 07 /14. 4508 54 /14.	 4 x LED STRIP 6,5W 350mA.		

Check additional product specifications at the end of this catalogue: Technical information /
 Consultar especificaciones adicionales del producto al final del catálogo: Información Técnica.

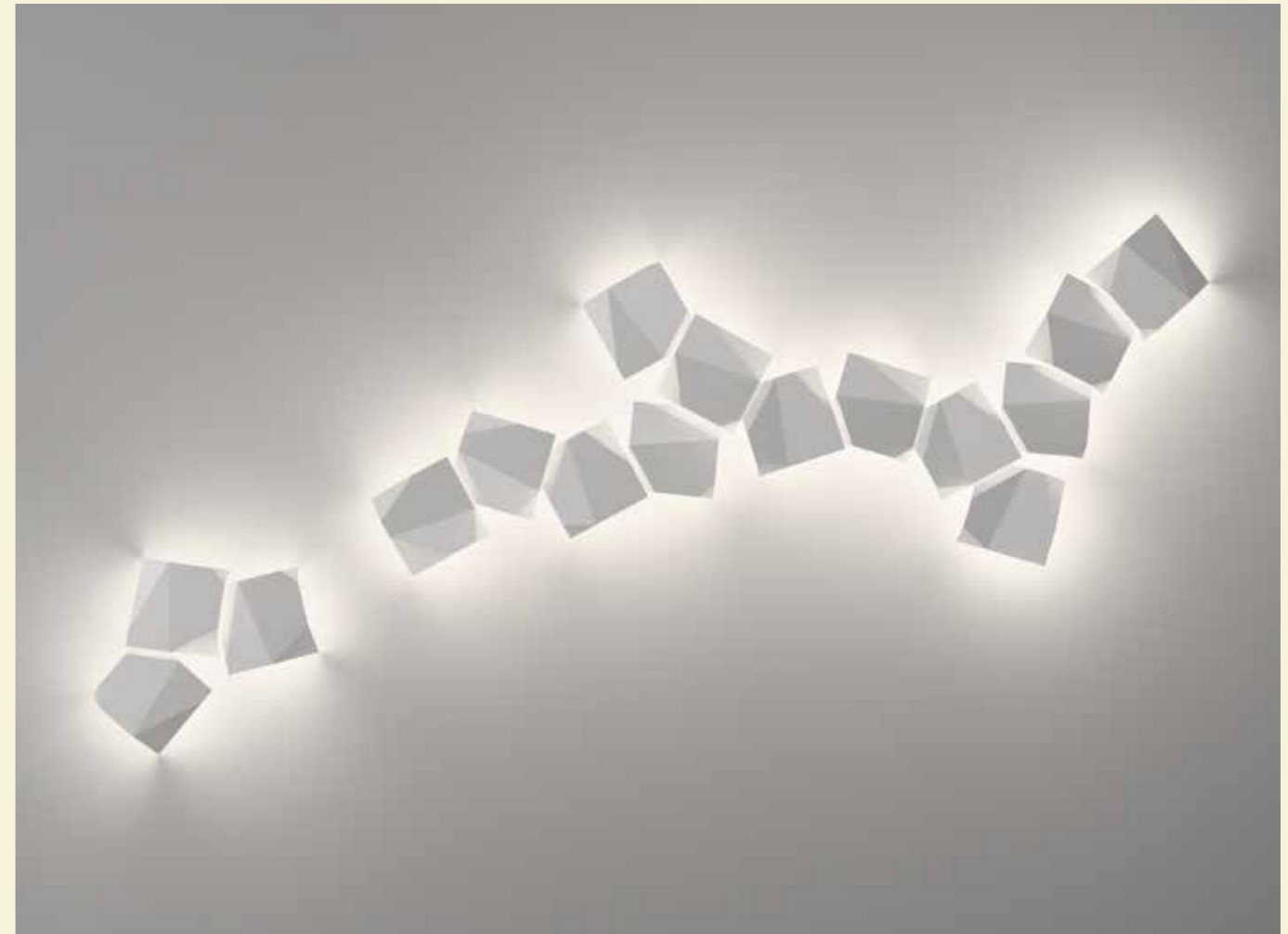

Suite

Design by Jordi Vilardell & Meritxell Vidal.

Reinterprets and updates the traditional combination of side table or shelf with table lamp. Its warm and comfortable lighting effect appears when least expected, a pleasant luminous surprise.

Suite



6035 93 /10. 6045 93 /10. 6041 93 /10.

Suite

Pages: A-132. B-180. C-293.

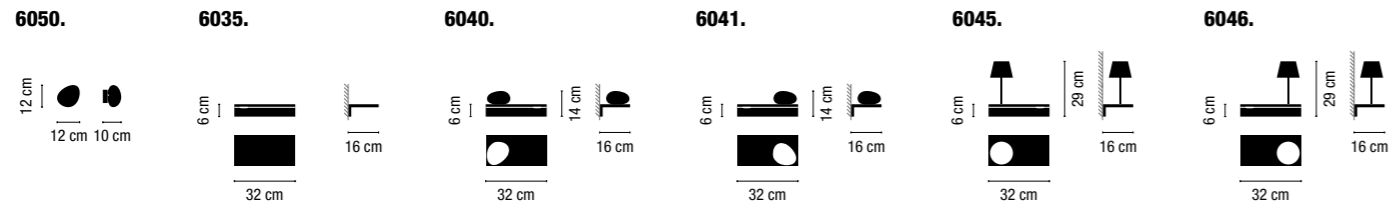

Polycarbonate diffuser / Difusor de policarbonato.	6035 14 /10. 6035 93 /10.	1 x LED STRIP 24V 1,63W.	LED IP20 CE		
LED on/off switch on the bottom cover. Reading light matt mink lacquer, mounted on shelf. Polycarbonate diffuser / Interruptor on/off en la tapa inferior. Luz de lectura lacada visón mate, montada en estante. Difusor de policarbonato.	6045 14 /10. 6045 93 /10. 6046 14 /10. 6046 93 /10.	1 x LED STRIP 24V 1,63W. 1 x LED 4,5W 350mA.	LED IP20 CE	<ul style="list-style-type: none"> 14 Matt chocolate lacquer / Lacado marrón oscuro mate. 93 Matt white lacquer / Lacado blanco mate. 	/10. 2700 °K. Dimmable: No.
Matt triplex opal blown glass diffuser / Difusor de vidrio soplado opal mate triplex.	6040 14 /10. 6040 93 /10. 6041 14 /10. 6041 93 /10.	1 x LED 4,5W 350mA.	LED IP20 CE		
	6050 93 /10.	1 x LED 4,5W 350mA.	LED IP20 CE Bi-volt	<ul style="list-style-type: none"> 93 Matt white lacquer / Lacado blanco mate. 	

Check additional product specifications at the end of this catalogue: Technical information / Consultar especificaciones adicionales del producto al final del catálogo: Información Técnica.

6050 93 /10.

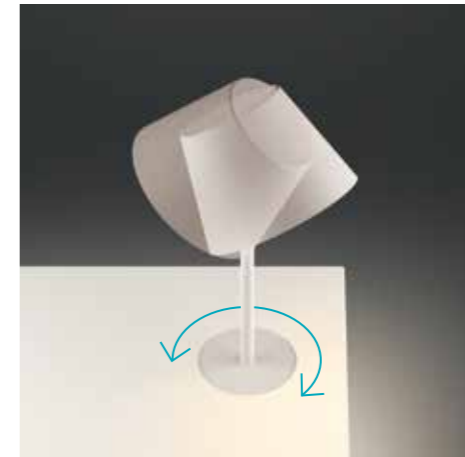

Micro

Design by Ramos & Bassols.



Like an eclipse, just at that moment when the moon passes over the sun leaving only a ring of light.

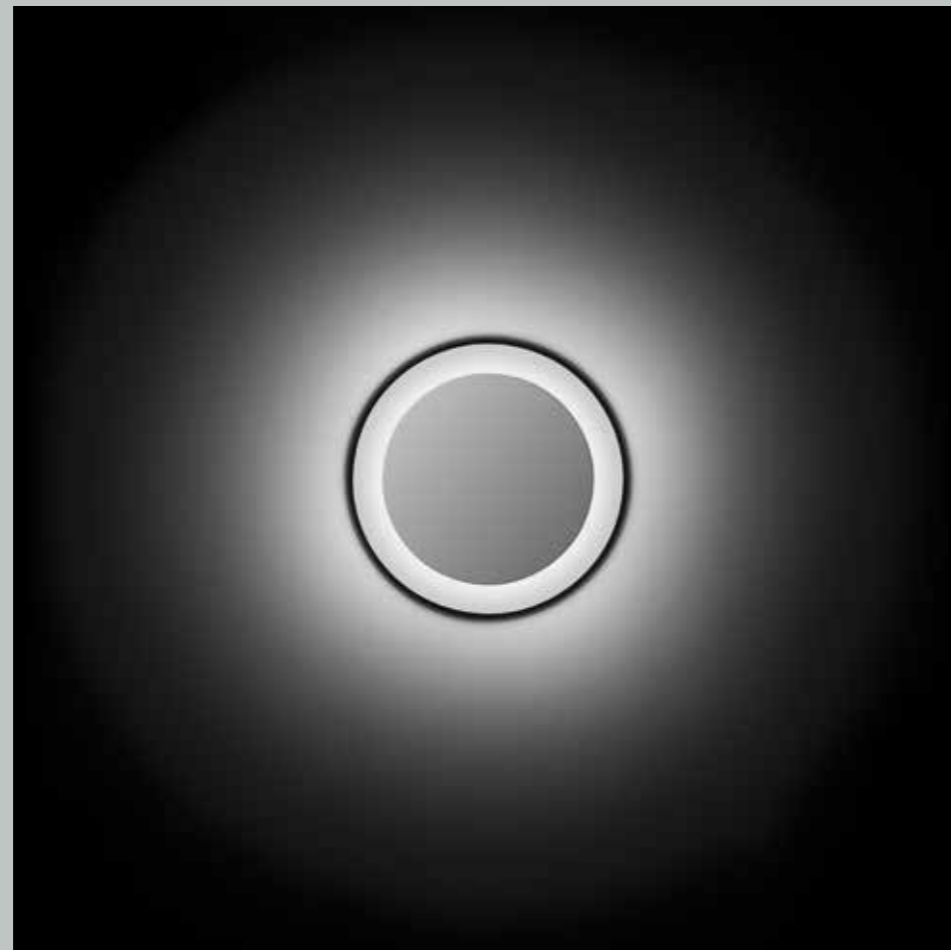

2015 03 /10.



Micro



2015 03 /10.



2015 03 /10.

2015.

5 cm
 1
 10 cm
 ø 10 cm
 ø 13,2 cm

A

Pages: A-298 / 394.

Polycarbonate diffuser / Difusor de policarbonato.

LED IP65 CE Bi-volt

2015 03 /10.
2015 54 /10. 3 x LED 1W 350mA

03 White lacquer / Lacado blanco.
 54 Oxide lacquer / Lacado óxido.

/10.
 2700 °K.
 Dimmable: No.

Surface fitting / Superficie
 Check additional product specifications at the end of this catalogue: Technical information /
 Consultar especificaciones adicionales del producto al final del catálogo: Información Técnica.

I.Cono

Design by Lievore, Altherr, Molina.



I.Cono represents an exercise in the fully resolved harmony of the present and the future, following the most exquisite traditions.



0720.

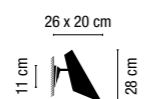

0725.

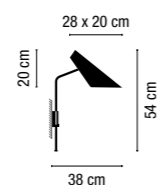

Pages: A-146. B-198. C-302.

Policarbonate difuser / Difusor de policarbonato.

<p>0720 03. 0720 04. 0720 59. 0720 93.</p>			<p> 1 x LED STAR CLASSIC P40 E14 230V 6W.</p> <p> OR 1 x COMPACT FLUORESCENT E14 230V 15W. (MEGAMAN LILIPUT PLUS o similar) Max.</p>	<p> 03 Gloss white lacquer / Lacado blanco brillo.</p> <p> 04 Gloss black lacquer / Lacado negro brillo.</p> <p> 59 Matt mink lacquer / Lacado visón mate.</p> <p> 93 Matt white lacquer / Lacado blanco mate.</p> <p> vibia.com Finish customization at / Personaliza acabado en</p>
<p>0725 03. 0725 04. 0725 59. 0725 93.</p>	<p>Adjustable height / Altura regulable.</p>		<p> OR 1 x E14 230V 46W Eco Max.</p>	

Check additional product specifications at the end of this catalogue: Technical information / Consultar especificaciones adicionales del producto al final del catálogo: Información Técnica.



0725 03.

Puck Wall Art

Design by Jordi Vilardell.



Based on formats superimposed over one another
on a plane of plastic dynamic compositions.

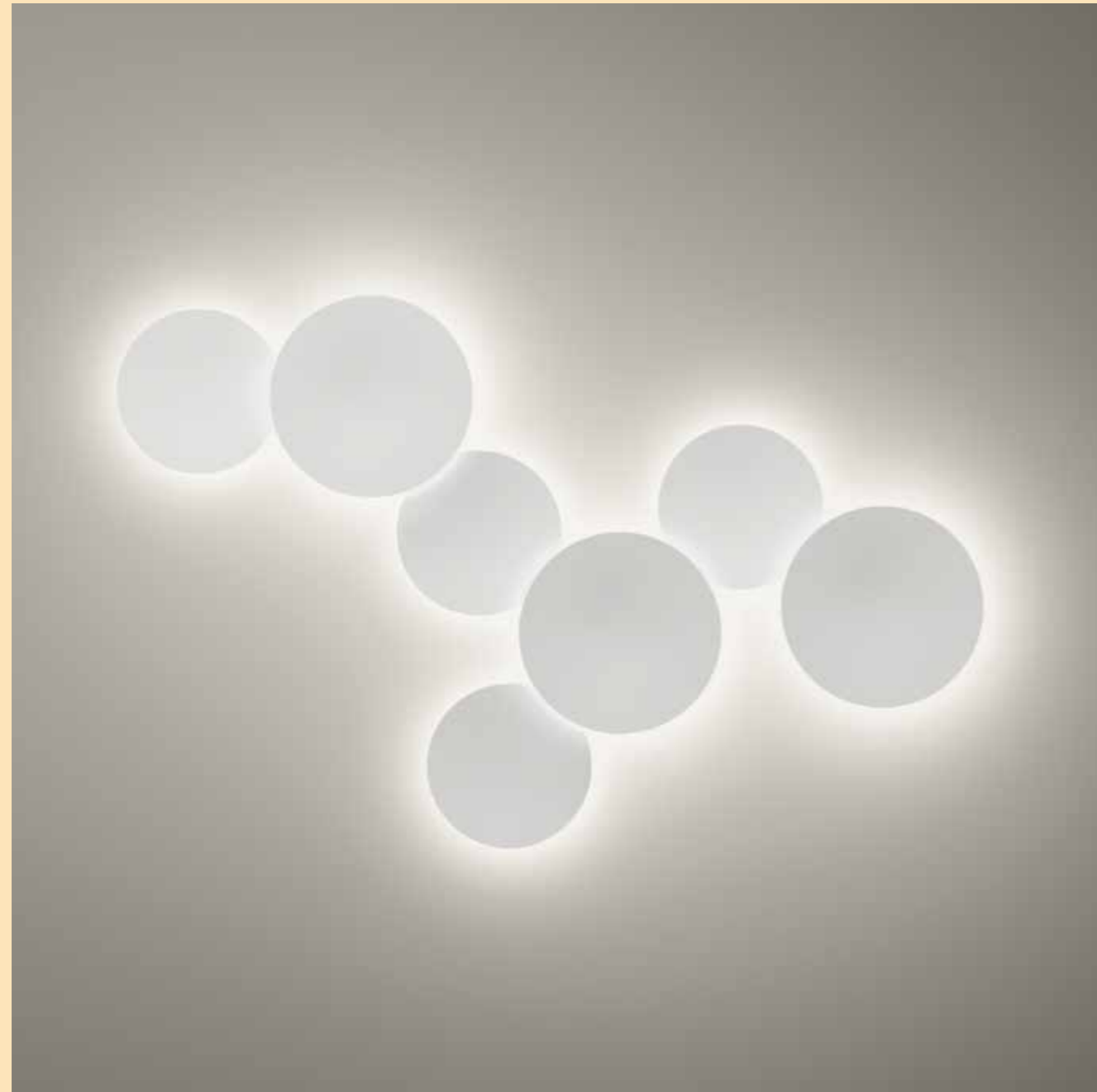

5460 03. 5464 14.

Puck Wall Art

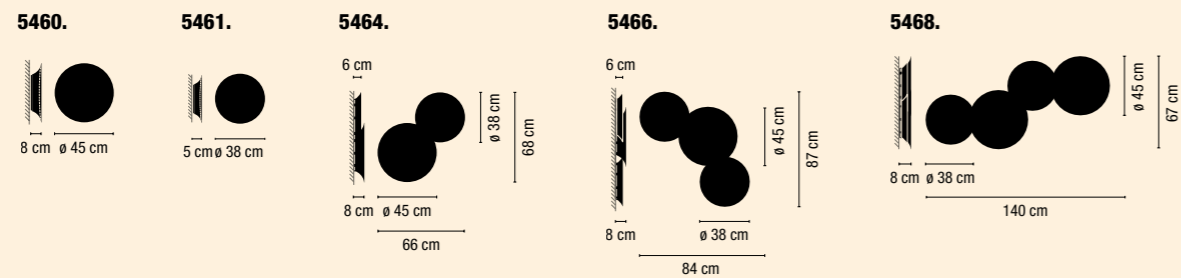

Acrylic diffuser / Difusor de metacrilato.



5460 03. 5460 08. 5460 14.	<input type="radio"/> 1 x 2GX13 230V 22W (T5C)	<ul style="list-style-type: none"> 03 Matt white lacquer / Lacado blanco mate. 08 Orange lacquer / Lacado naranja. 14 Chocolate lacquer / Lacado marrón oscuro.
5461 03. 5461 08. 5461 14.		
5464 03. 5464 08. 5464 14.	<input type="radio"/> 2 x 2GX13 230V 22W (T5C)	
5466 03. 5466 08. 5466 14.	<input type="radio"/> 3 x 2GX13 230V 22W (T5C)	
5468 03. 5468 08. 5468 14.	<input type="radio"/> 4 x 2GX13 230V 22W (T5C)	

Check additional product specifications at the end of this catalogue: Technical information / Consultar especificaciones adicionales del producto al final del catálogo: Información Técnica.

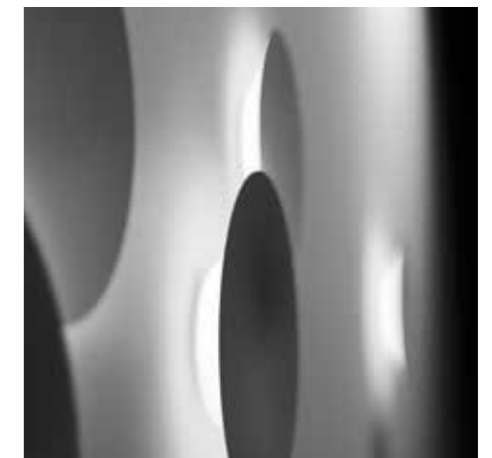

Create your product configuration quickly and easily at vibia.com

Go to vibia.com and discover the quickest, most efficient way to configure a unique lighting mural with Puck Wall Art.

Crea tu configuración de producto rápido y fácil en vibia.com

Entra en vibia.com y descubre la manera más rápida y eficiente de configurar un mural luminoso único con Puck Wall Art.

Alpha

Design by Ramos & Bassols.



An embedded light breaking free to serve.



7940 18 /10.



7940 03 /10.



Alpha

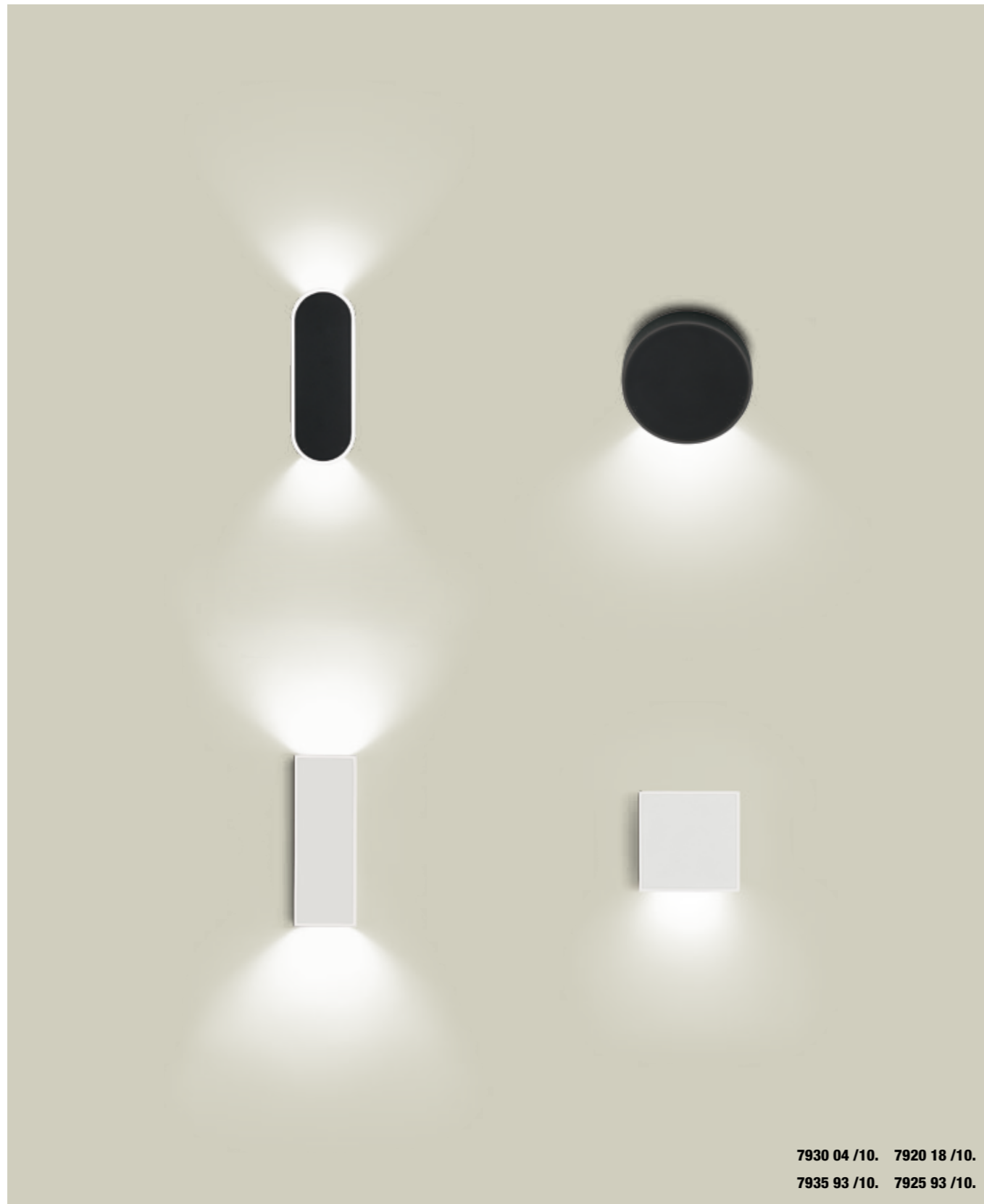

7925 04 /10.



7935 04 /10.

7950 18 /10.

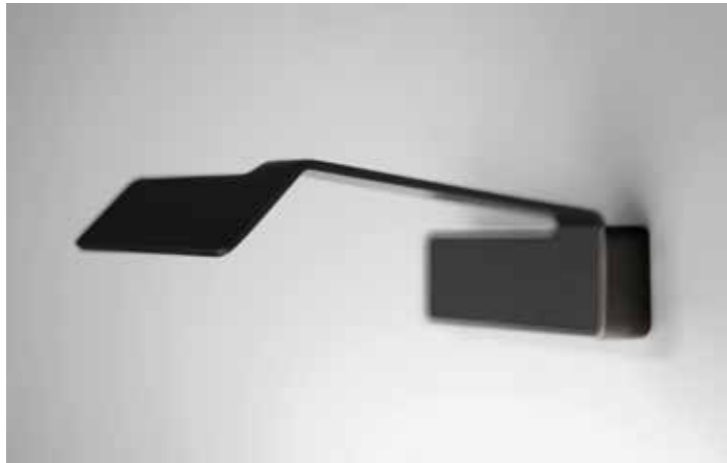

For big surfaces, the recommended distance between picture lights is 80 cm /
Para superficies de grandes dimensiones, la interdistancia recomendada entre los iluminacuadros es de 80 cm.

Alpha



7955 03 /10.

Alpha

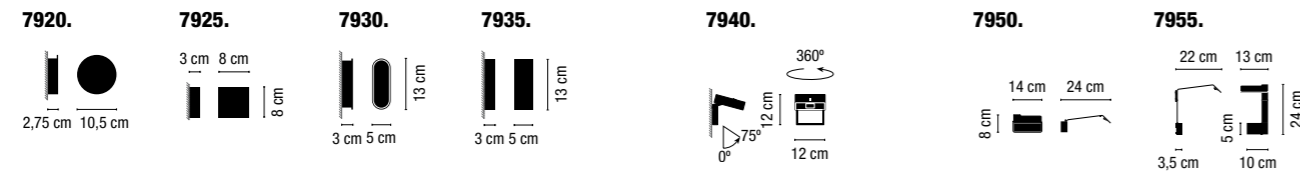

Surface / Superficie.	7920 03 /10. 7925 03 /10. 7920 04 /10. 7925 04 /10. 7920 18 /10. 7925 18 /10. 7920 93 /10. 7925 93 /10.	1 x LED 2,1W 700mA.	<ul style="list-style-type: none"> 03 Matt white lacquer and chrome / Lacado blanco mate y cromo. 04 Matt black lacquer and chrome / Lacado negro mate y cromo. 18 Matt graphite lacquer and black / Lacado grafito mate y negro. 93 Matt white lacquer / Lacado blanco mate. 	/10. 2700 °K. Dimmable: No.
	7930 03 /10. 7935 03 /10. 7930 04 /10. 7935 04 /10. 7930 18 /10. 7935 18 /10. 7930 93 /10. 7935 93 /10.	2 x LED 2,1W 700mA.		
	7940 03 /10. 7940 04 /10. 7940 18 /10. 7940 93 /10.	1 x LED 2,1W 700mA.		
	7950 03 /10. 7950 04 /10. 7950 18 /10. 7950 93 /10.	3 x LED 2,1W 700mA.		
RA: 80. Light beam with no IR and UV / Haz de luz libre de IR y UV.	7955 03 /10. 7955 04 /10.	3 x LED 2,1W 700mA.	<ul style="list-style-type: none"> 03 White lacquer / Lacado blanco. 04 Black lacquer / Lacado negro. 	

Check additional product specifications at the end of this catalogue: Technical information /
 Consultar especificaciones adicionales del producto al final del catálogo: Información Técnica.

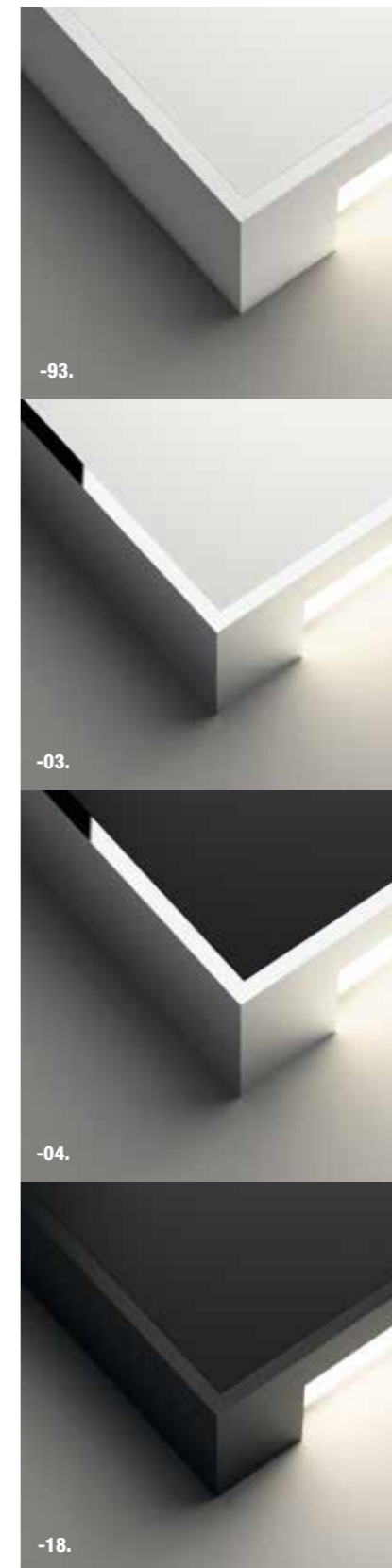

Centric

Design by Ramos & Bassols.



Some design objects can integrate with the architecture,
influencing it by making rooms come alive.



5700 93 /1B.



5710 93 /1B.

Centric



5700 93 /1B.

5700.

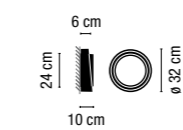

5710.

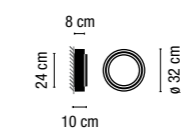

Pages: A-218. B-316.

Methacrylate diffuser / Difusor de metacrilato.



5700 58 /1B. 5710 58 /1B.
5700 93 /1B. 5710 93 /1B.

1 x LED PLATE 15,2W 700mA.
 2 x LED STRIP 4W 700mA.

58 Matt cream lacquer / Lacado crema mate.
 93 Matt white lacquer / Lacado blanco mate.

/1B.
 2700 °K.
 Dimmable: 1-10V + Push.

Check additional product specifications at the end of this catalogue: Technical information /
 Consultar especificaciones adicionales del producto al final del catálogo: Información Técnica.

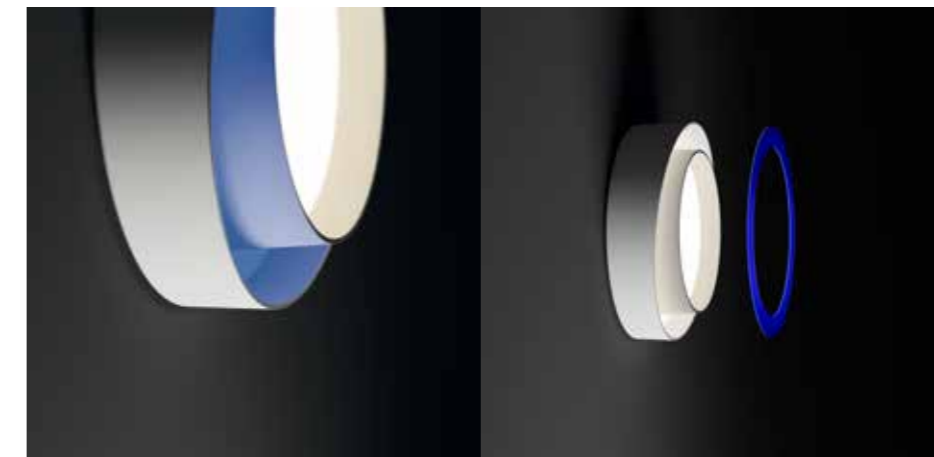

Additional color filter /
 Filtro adicional de color

FoldSurface

Design by Arik Levy.



Fold started as an image in my mind, the image of a wall with folds that created the sensation of doubled-over paper.

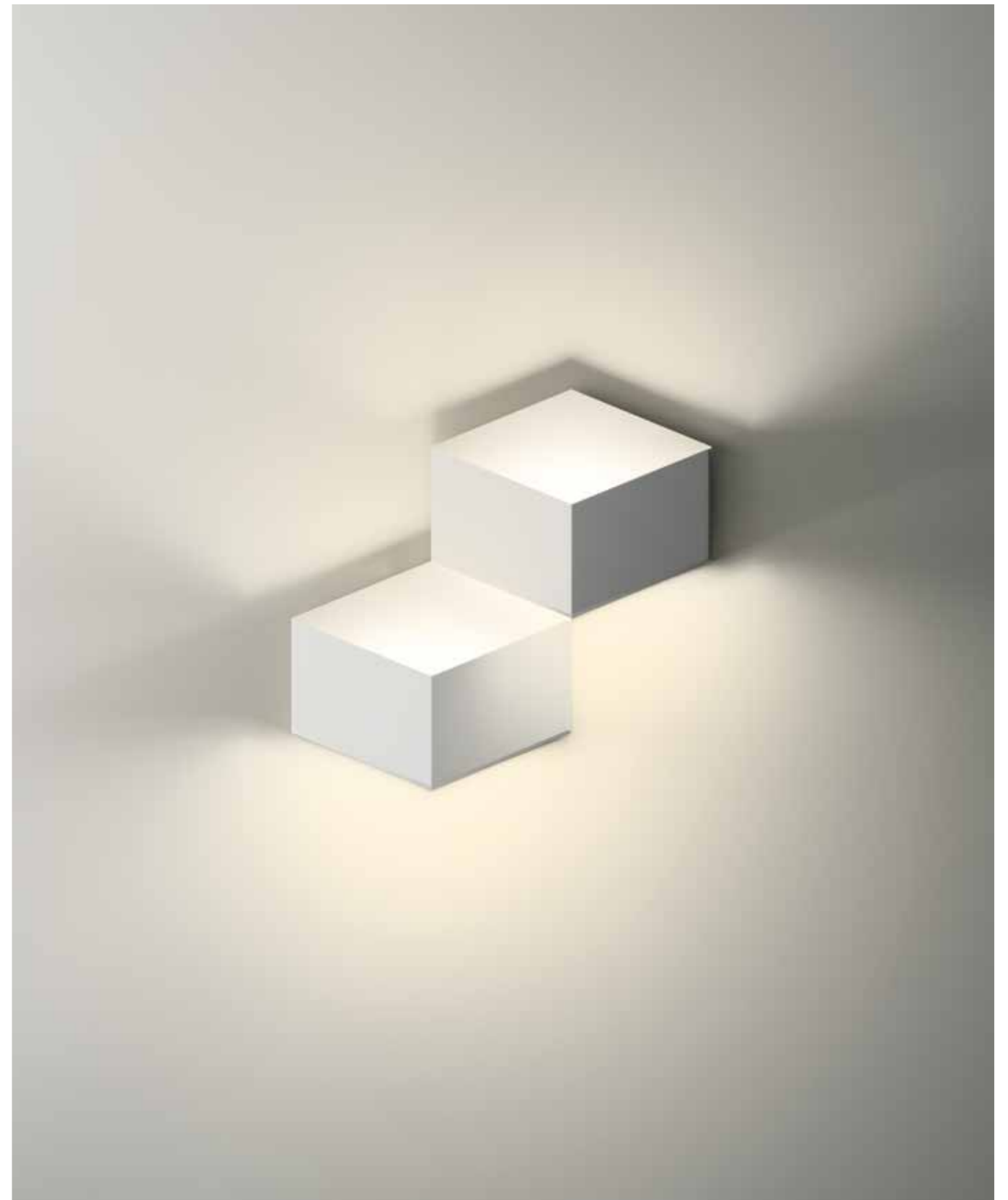
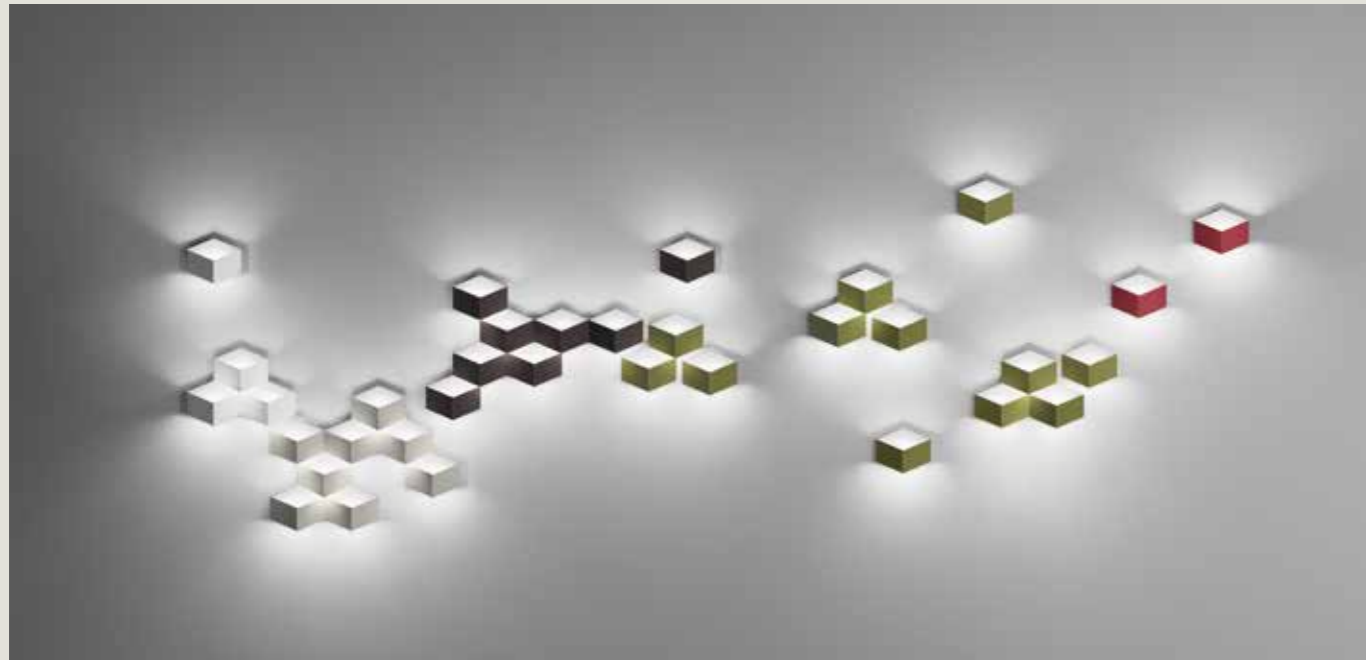

FoldSurface

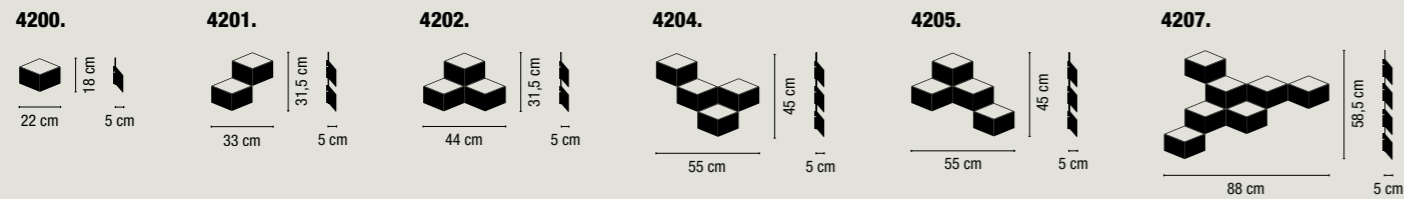

Polycarbonate diffuser / Difusor de policarbonato.

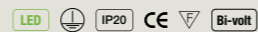

4200 06 /10. 4200 07 /10. 4200 14 /10. 4200 58 /10.	2 x LED 2,1W 700mA.	<ul style="list-style-type: none"> ● 06 Matt red lacquer / Lacado rojo mate. ● 07 Matt green lacquer / Lacado verde mate. ● 14 Matt chocolate lacquer / Lacado marrón oscuro mate. ● 58 Off-white matt lacquer / Lacado blanco roto mate. <p>/10. 2700 °K. Dimmable: No.</p>
4201 06 /10. 4201 07 /10. 4201 14 /10. 4201 58 /10.	4 x LED 2,1W 700mA.	
4202 06 /10. 4202 07 /10. 4202 14 /10. 4202 58 /10.	6 x LED 2,1W 700mA.	
4204 06 /10. 4204 07 /10. 4204 14 /10. 4204 58 /10. 4205 06 /10. 4205 07 /10. 4205 14 /10. 4205 58 /10.	8 x LED 2,1W 700mA.	
4207 06 /10. 4207 07 /10. 4207 14 /10. 4207 58 /10.	14 x LED 2,1W 700mA.	

Check additional product specifications at the end of this catalogue: Technical information / Consultar especificaciones adicionales del producto al final del catálogo: Información Técnica.

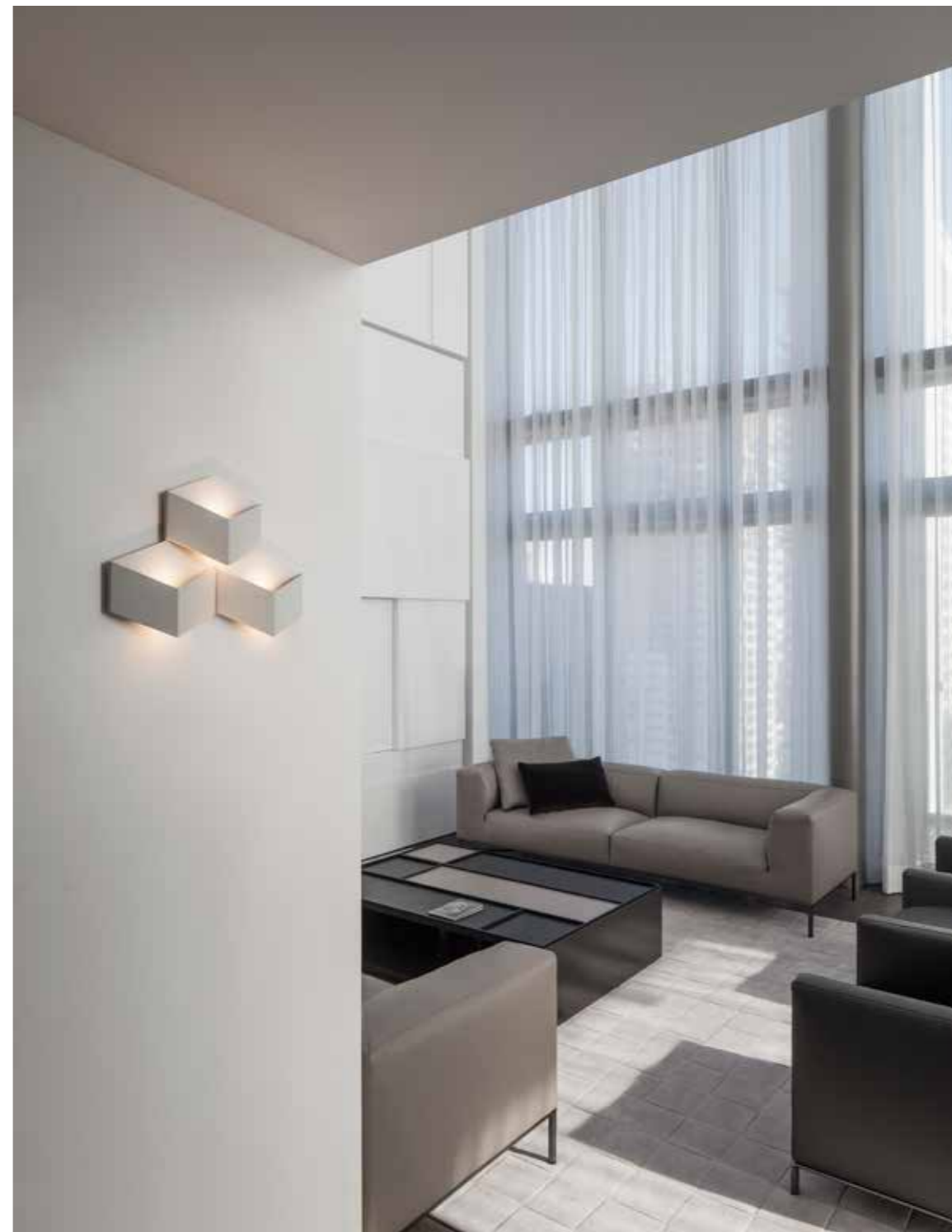

4202 58 /10.

FoldBuilt-in

Design by Arik Levy.



Light and shapes that create the feeling of a slightly curved piece of paper.



4210 03 /10. 4211 03 /10.

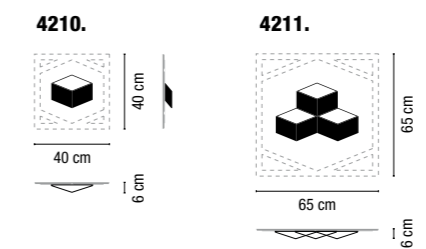

Polycarbonate diffuser / Difusor de policarbonato.

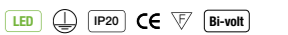

<p>4210 03 /10.</p>	<p>⊕ 2 x LED 2,1W 700mA.</p>	<p>● 03 Matt white lacquer / Lacado blanco mate.</p>	<p>/10. 2700 °K. Dimmable: No.</p>
<p>4211 03 /10.</p>	<p>⊕ 6 x LED 2,1W 700mA.</p>		

Check additional product specifications at the end of this catalogue: Technical information / Consultar especificaciones adicionales del producto al final del catálogo: Información Técnica.



Puck

Design by Jordi Vilardell.



Toy like, a visual game based on mathematical constructs of compositions and intersections. Circles that touch and overlap with one another.



5425 03. 5427 03 /10.



5425 03. 5427 03 /10.

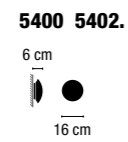

5400 5402.

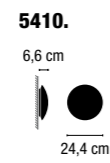

5410.

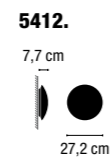

5412.

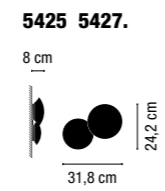

5425 5427.

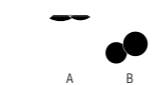

Pages: A-238. B-326.

Matt triplex opal blow glass-diffuser / Difusor de vidrio soplado opal mate triplex.

5400 03.	1 x G9 230V 33W Eco.		● 03 White / blanco.	
5410 03.	1 x G9 230V 48W Eco.			
5425 03.	2 x G9 230V 33W Eco.			
5402 03 /10.	1 x LED PLATE 3W 350mA.		● 03 White / blanco.	/10. 2700 °K. Dimmable: No.
5412 03 /10.	1 x LED PLATE 7,35W 350mA.			
5427 03 /10.	2 x LED PLATE 3W 350mA.			

All versions require only one electrical connection /
Todas las versiones sólo requieren un punto de conexión eléctrica.
Check additional product specifications at the end of this catalogue: Technical information /
Consultar especificaciones adicionales del producto al final del catálogo: Información Técnica.

Puck

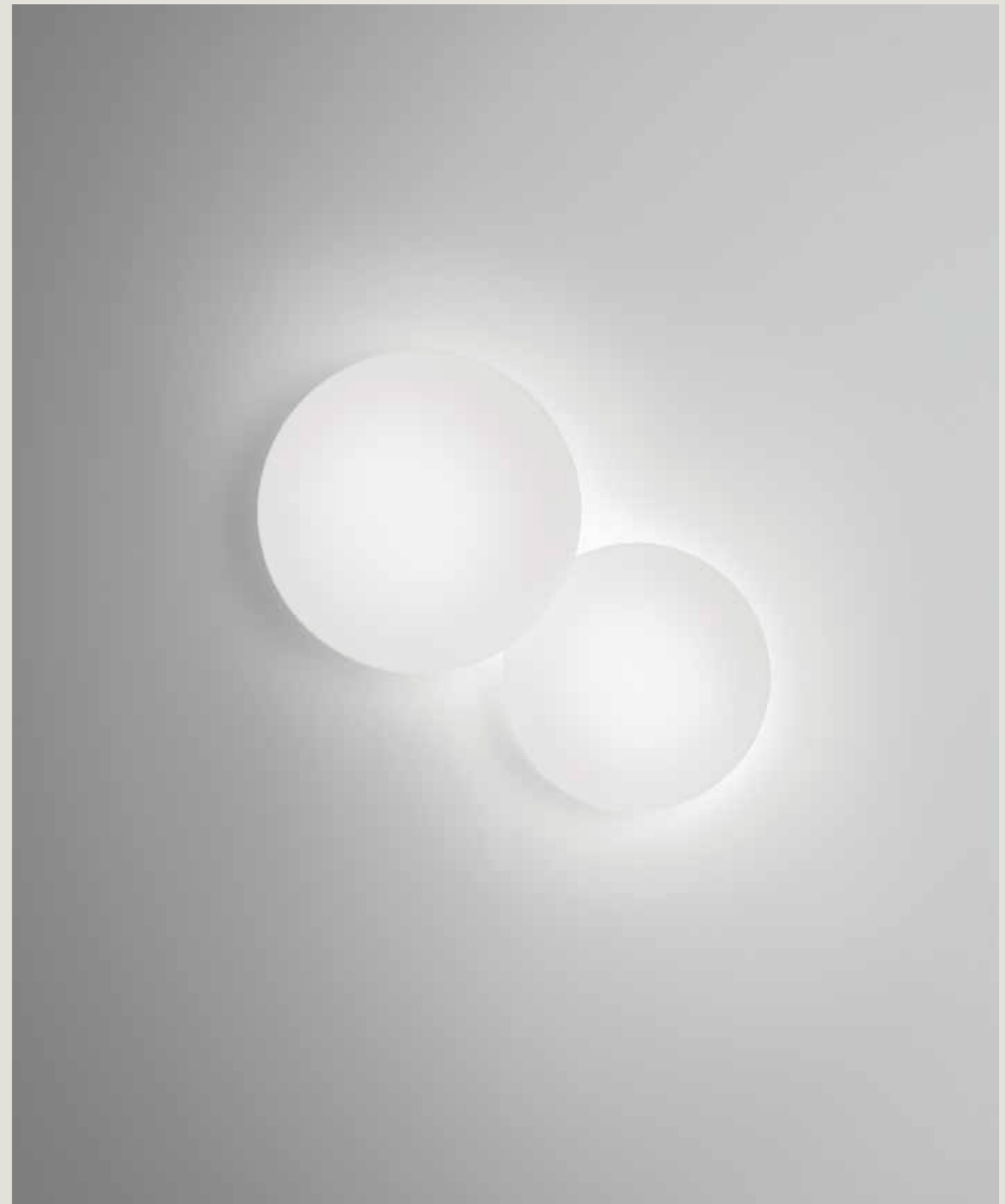

5425 03. 5427 03 /10.

Scotch

Design by Oscar & Sergi Devesa.



Rounded transparent glass featuring a very soft and pleasing profile, almost imperceptible.



Scotch



Pages: 262 / 330 / 400.

Pressed-glass diffuser / Difusor de vidrio prensado.

0960 01.	1 x G9 230V 40W Max.	IP20 CE Bi-volt	01 Chrome / Cromo.	
0962 01 /10.	1 x LED 3W 350mA.	LED IP65 CE Bi-volt	01 Chrome / Cromo.	/10. 2700 °K. Dimmable: No.

Check additional product specifications at the end of this catalogue: Technical information /
Consultar especificaciones adicionales del producto al final del catálogo: Información Técnica.



0960 01.



0962 01 /10.

Funnel



Material, light and space integrated within a light fitting.
The perfect equation for an unsurpassable result.



2004 03.

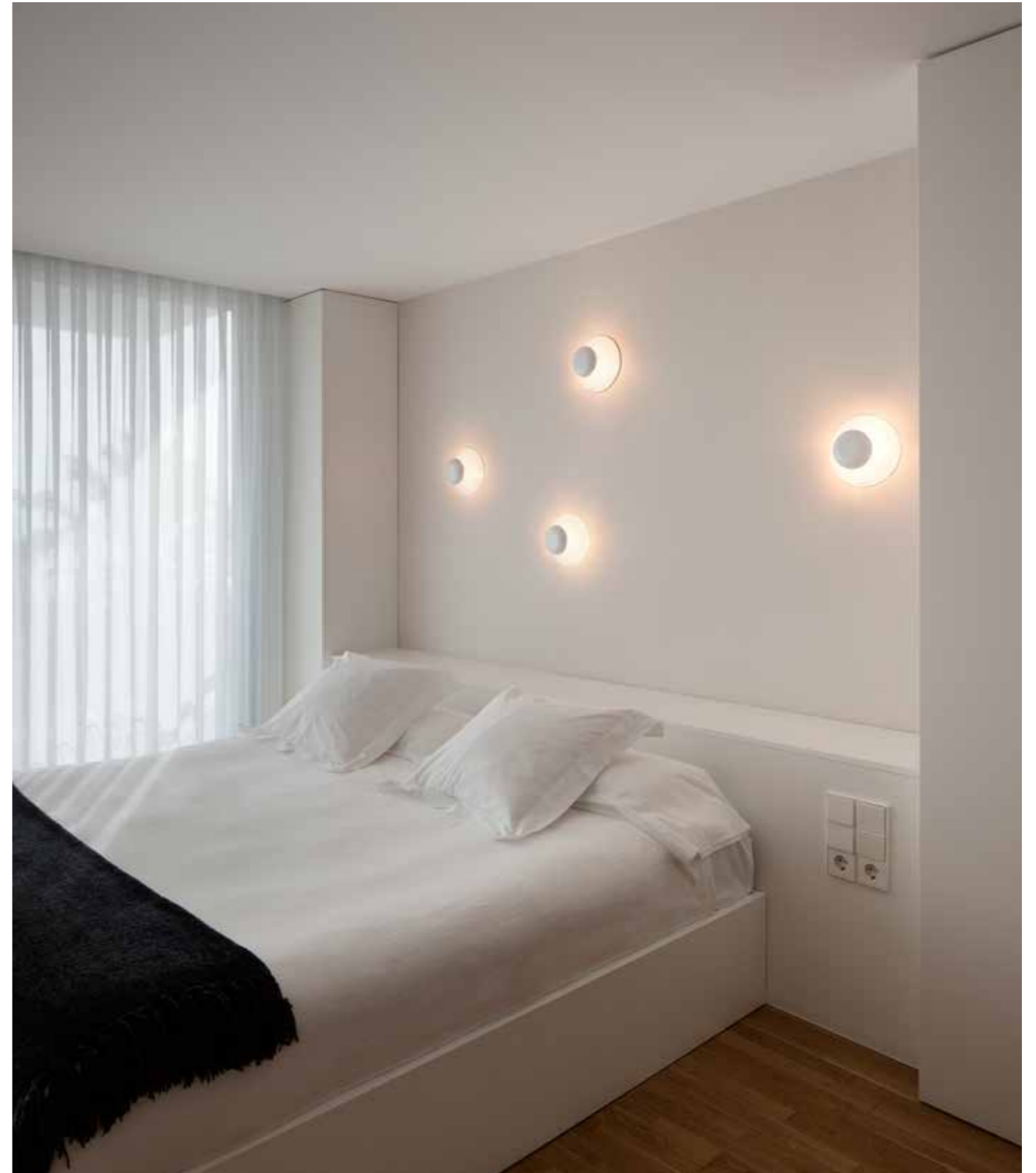

2004 03.

Funnel

© The Original

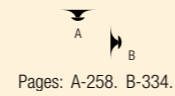
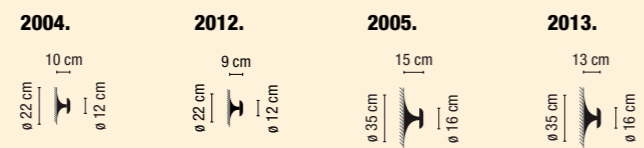

Pages: A-258. B-334.

Aluminum diffuser / Difusor de aluminio.

Mini ø 22 cm	2004 01. 2004 03. 2004 04. 2004 06.	2 x G9 230V 60W Eco Max.	<ul style="list-style-type: none"> 01 Chrome / Cromo. 03 Gloss white lacquer / Lacado blanco brillo. 04 Gloss black lacquer / Lacado negro. 06 Gloss red lacquer / Lacado rojo. 		
	2012 93 /10. 2012 51 /10.	1 x LED PLATE 6,3W 350mA.	<ul style="list-style-type: none"> 93 Matt white lacquer / Lacado blanco mate. 51 Matt gold leaf / Pan de oro mate. 		/10. 2700 °K. Dimmable: No.
ø 35 cm	2005 03.	3 x G9 230V 48W Eco Max.	<ul style="list-style-type: none"> 03 Gloss white lacquer / Lacado blanco brillo. 		
	2013 93 /1A. 2013 51 /1A.	6 x LED 4,5 W 350mA.	<ul style="list-style-type: none"> 93 Matt white lacquer / Lacado blanco mate. 51 Matt gold leaf / Pan de oro mate. 		/1A. 2700 °K. Dimmable: 1-10V + DALI + Push.

Check additional product specifications at the end of this catalogue: Technical information /
 Consultar especificaciones adicionales del producto al final del catálogo: Información Técnica.

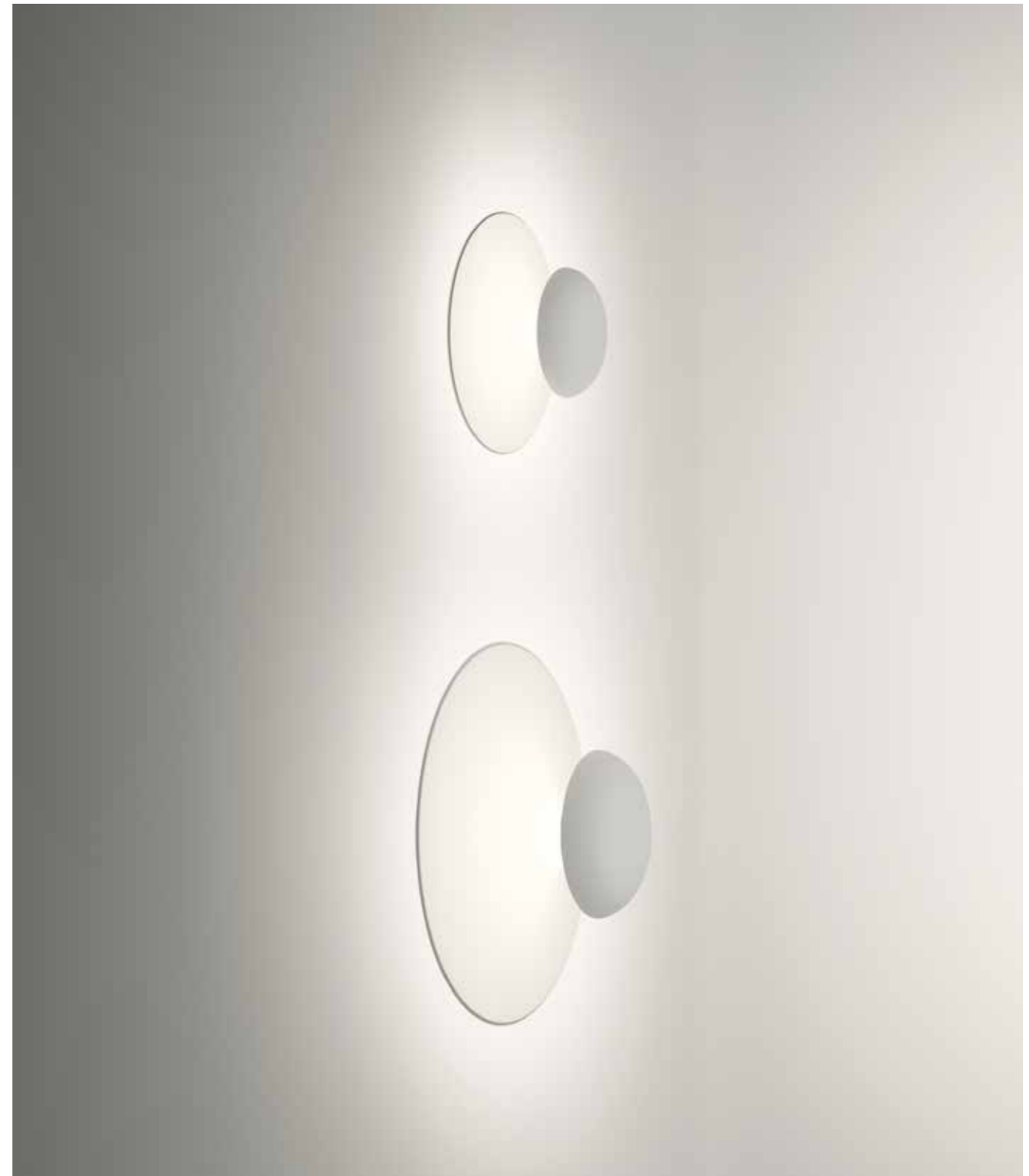

2012 93 /10. 2013 93 /1A.

Swing

Design by Lievore, Altherr, Molina.



Refined movement, pure tradition.

Swing



0526 93 /10.



0514 93 /10.



0526.

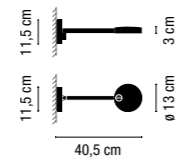

Pages: A-152. B-188. C-338.



0509.

0514.

0509.

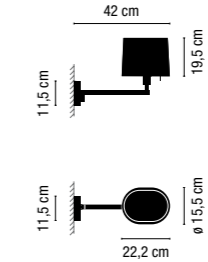

0514.

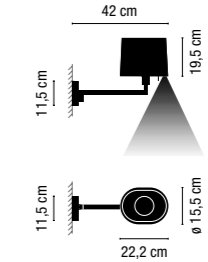

Adjustable metal diffuser / Difusor de metal orientable.	0526 01 /10. 0526 18 /10. 0526 93 /10.	1 x LED 4,5W 350mA.	LED IP20 CE Bi-volt	<ul style="list-style-type: none"> ● 01 Chrome / Cromo. ● 18 Matt graphite lacquer / Lacado grafito mate. ● 93 Matt white lacquer / Lacado blanco mate. 	/10. 2700 °K. Dimmable: No.
---	---	---------------------	---------------------	--	--

Check additional product specifications at the end of this catalogue: Technical information /
Consultar especificaciones adicionales del producto al final del catálogo: Información Técnica.

Screen shade / Pantalla screen.	0509 01. 0509 18. 0509 93.	<ul style="list-style-type: none"> ● 1 x Core Pro LEDbulb E27 230V 9W. ● OR 1 x COMPACT FLUORESCENT E27 230V 15W Max. ● OR 1 x E27 230V 70W Eco Max. 	IP20 CE Bi-volt	<ul style="list-style-type: none"> ● 01 Chrome / Cromo. ● 18 Matt graphite lacquer / Lacado grafito mate. ● 93 Matt white lacquer / Lacado blanco mate. 	
	0514 01 /10. 0514 18 /10. 0514 93 /10.	<ul style="list-style-type: none"> ● 1 x Core Pro LEDbulb E27 230V 9W. ● OR 1 x COMPACT FLUORESCENT E27 230V 15W Max. ● OR 1 x E27 230V 70W Eco Max. ● 1 x LED 2,1W 700mA. 	LED IP20 CE Bi-volt	<ul style="list-style-type: none"> ● 01 Chrome / Cromo. ● 18 Matt graphite lacquer / Lacado grafito mate. ● 93 Matt white lacquer / Lacado blanco mate. 	/10. 2700 °K. Dimmable: No.

Millenium

Design by Ramos & Bassols.



A linear fitting which subtly compliments the mirror,
an exercise in self-reflection.



8092 01.



8095 01.



8095 01.

Millenium

8090.

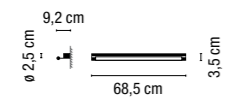

8091.

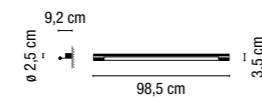

8092.

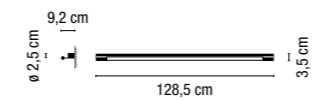

8093.

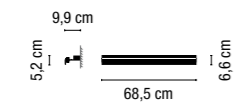

8094.

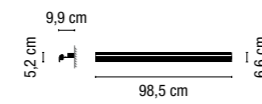

8095.

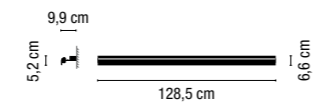

Polycarbonate diffuser / Difusor de policarbonato.



8090 01. 8093 01. — 1 x G5 230V 24W (T5).

8091 01. 8094 01. — 1 x G5 230V 39W (T5).

8092 01. 8095 01. — 1 x G5 230V 54W (T5).

01 Chrome / Cromo.

Electronic ballast / Reactancia electrónica.

Check additional product specifications at the end of this catalogue: Technical information / Consultar especificaciones adicionales del producto al final del catálogo: Información Técnica.



Adjustable reflector / Reflector ajustable.



8092 01.

Sparks

Design by Arik Levy.



Spark-like; an idea that fizzes and sparkles.

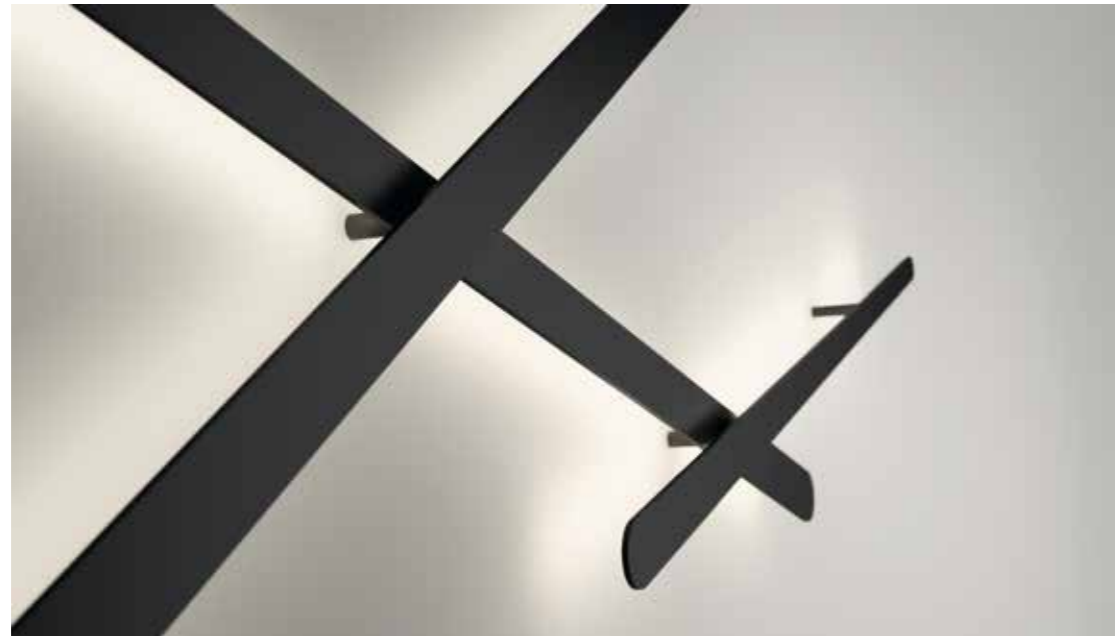

1705 59 /13.



1715 18 /13.

1700.

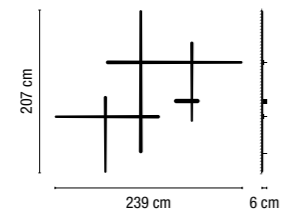

1705.

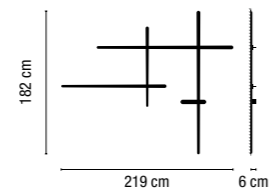

1715.

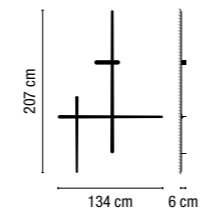

Polycarbonate diffuser / Difusor de policarbonato.

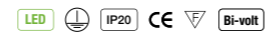

1700 18 /13. 1700 59 /13.	1 x LED STRIP 30V 58,5W.	<ul style="list-style-type: none"> 18 Matt graphite lacquer / Lacado grafito mate. 59 Matt mink lacquer / Lacado visón mate. 	/13. 2700 °K. Dimmable: 1-10V.
1705 18 /13. 1705 59 /13.	1 x LED STRIP 30V 50,7W.		
1715 18 /13. 1715 59 /13.	1 x LED STRIP 30V 34,8W.		

Check additional product specifications at the end of this catalogue: Technical information / Consultar especificaciones adicionales del producto al final del catálogo: Información Técnica.

Sparks

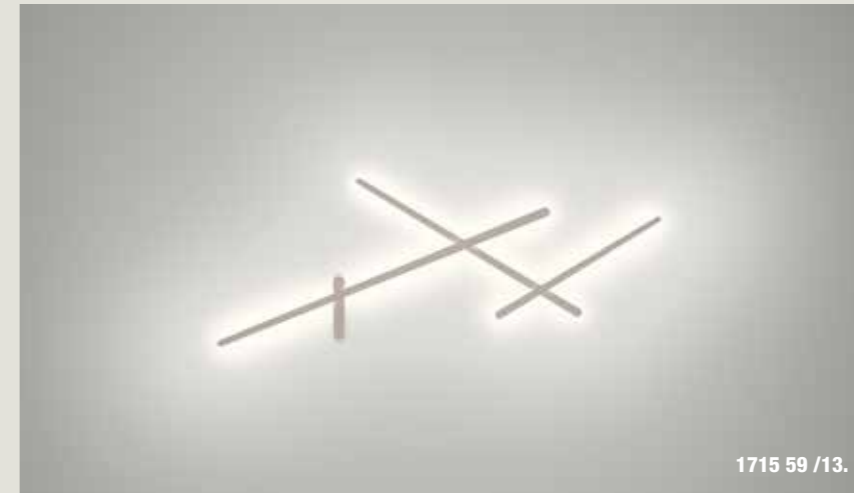

1715 59 /13.

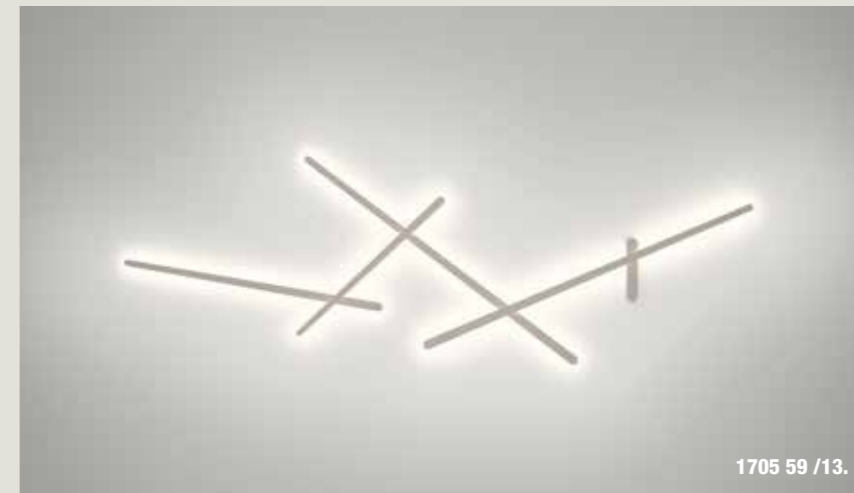

1705 59 /13.

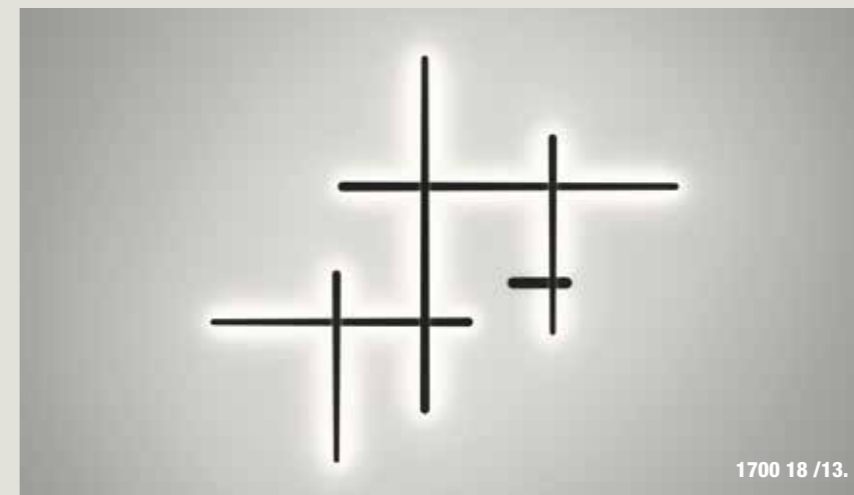

1700 18 /13.

Outdoor

Landscape Integration,
Living the Outdoors...



Landscape Integration

Points of light are integrated through formal and functional lighting relationships, becoming part of the overall plan where everything has a raison d'être.

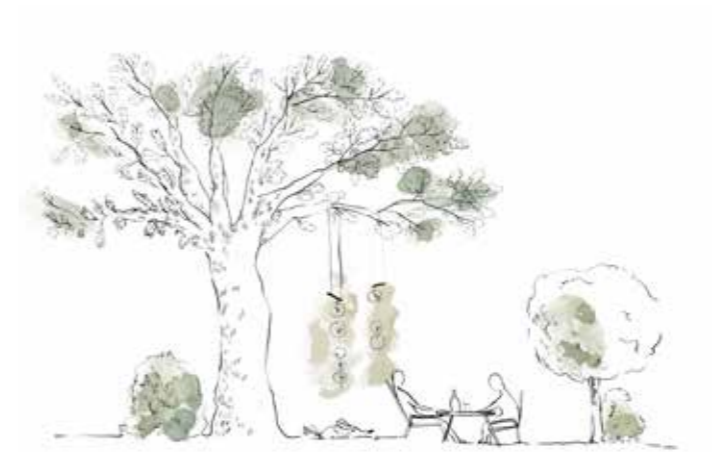

Living the Outdoors

Outdoor spaces become the backdrops where our lives are lived in the company of our peers, spaces where our future is played out day by day, places of socialise, places to rest.



Outdoors designed for Living. Light fittings providing warm, uplifting and natural ambiances, which invite spending time outdoors, evenings spent in good company at any time of the year.

Outdoor



Bamboo
pag. 364



Boxes
pag. 372



Break
pag. 382



Brisa
pag. 360



Empty
pag. 414



Halley
pag. 390



June
pag. 352



Meridiano
pag. 418



Micro
pag. 394



Origami
pag. 410



Palo Alto
pag. 406



Plis Outdoor
pag. 396



Plus
pag. 392



Scotch
pag. 400



Tree
pag. 402



Wind
pag. 376



June

Design by Ana Mir + Emili Padrós (emiliana design studio).



June transports us to the summer, a time of festivals and celebrations when our lives move outdoors to the open air.

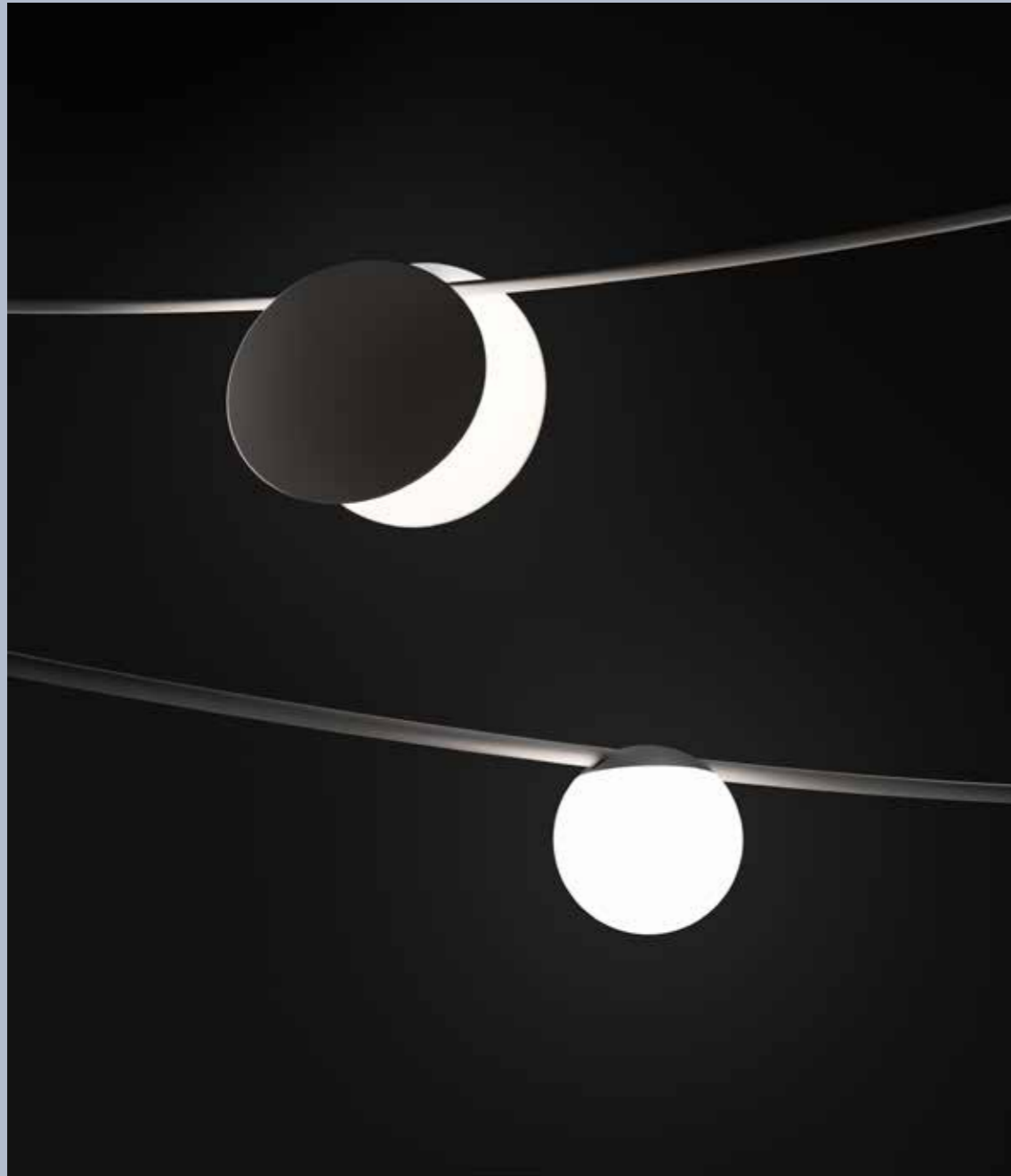

June

4765 54 /10.



4795 54 /15.

Tray with three units. Charge by contact /
Bandeja de tres unidades. Carga por contacto.



4765 54 /10.
4790 54 /15.

354



4790 54 /15. 4775 54 /10.



4775 54 /10.
4770 54 /10.

355



Outdoor

June

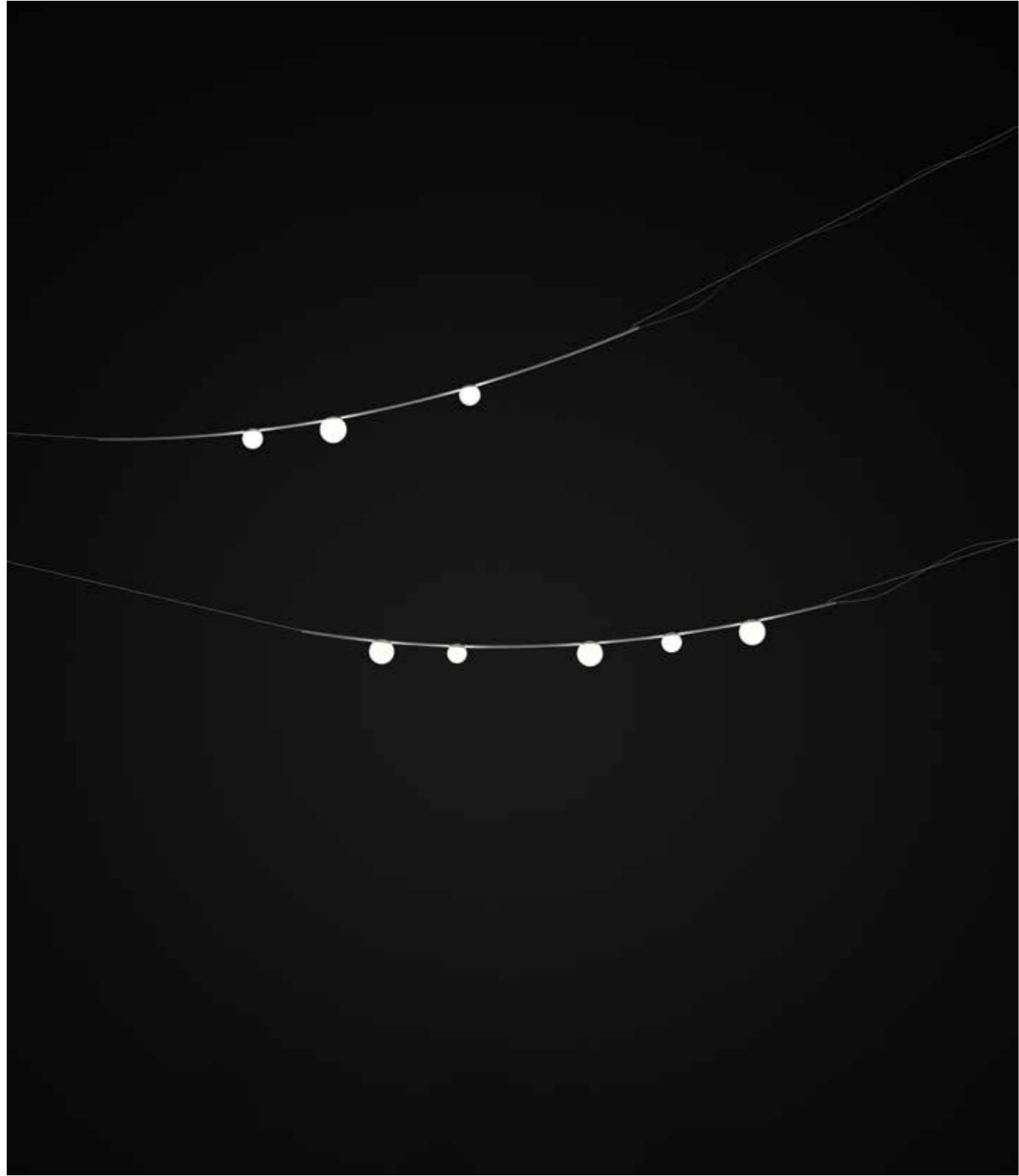

4745 54 /10. 4750 54 /10.



4790 54 /15. 4750 54 /10. 4730 54 /10.

June

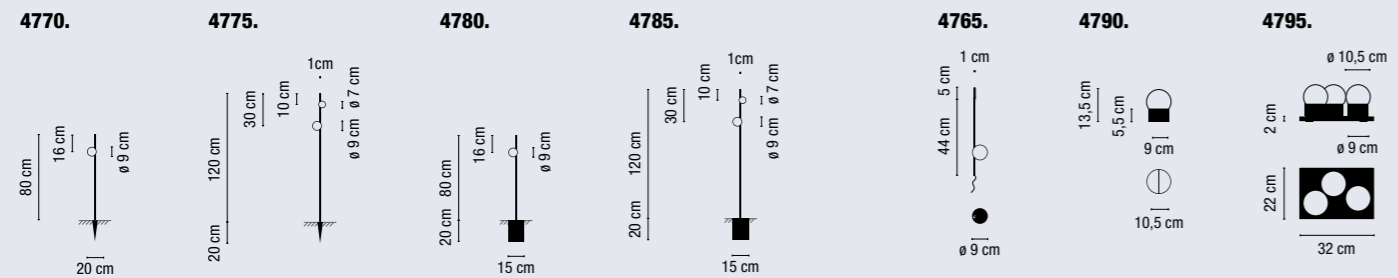
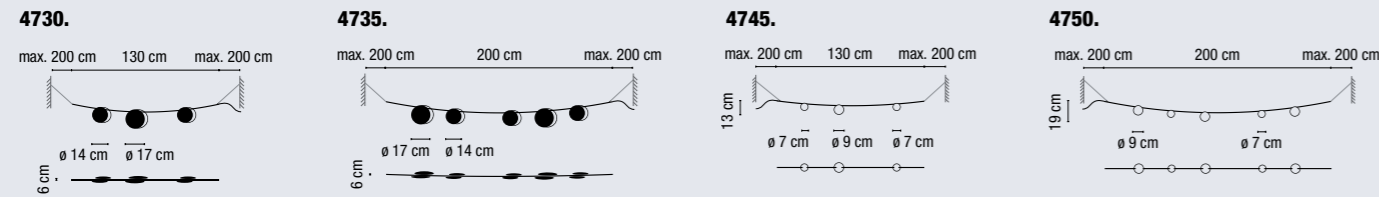

PVC+UV - diffuser / Difusor PVC+UV.	Garlands / Guirnaldas.	4730 54 /10.	3 x LED 1W 350mA.	LED, IP65, CE, Bi-volt	/10. 2700 °K. Dimmable: No.	
		4735 54 /10.	5 x LED 1W 350mA.	LED, IP65, CE, Bi-volt		
Opal blown glass diffuser / Difusor de vidrio soplado opal	Garlands / Guirnaldas.	4745 54 /10.	3 x LED 1W 350mA.	LED, IP65, CE, Bi-volt	/10. 2700 °K. Dimmable: No.	
		4750 54 /10.	5 x LED 1W 350mA.	LED, IP65, CE, Bi-volt		
	Portables / Portables.	4765 54 /10.	1 x LED 1W 350mA.	LED, IP65, CE, Bi-volt	/10. 2700 °K. Dimmable: No.	
		4790 54 /15. *	1 x LED 1W 350mA.	LED, IP20, CE, Bi-volt		/15. 2700 °K. Dimmable: Push.
		4795 54 /15. **	3 x LED 1W 350mA.	LED, IP20, CE, Bi-volt		
	Bollards / Balizas.	4770 54 /10. 4780 54 /10.	1 x LED 1W 350mA.	LED, IP65, CE, Bi-volt	/10. 2700 °K. Dimmable: No.	
4775 54 /10. 4785 54 /10.		2 x LED 1W 350mA.	LED, IP65, CE, Bi-volt			

● 54 Matt dark-brown lacquer /
Lacado marrón oscuro mate.



* Charge by removable cable / Carga mediante cable extraíble.
 ** Tray with three units. Charge by contact / Bandeja de tres unidades. Carga por contacto.
 Check additional product specifications at the end of this catalogue: Technical information /
 Consultar especificaciones adicionales del producto al final del catálogo: Información Técnica.

Brisa

Design by Lievore, Altherr, Molina.



Brisa is poetry, like a simple flower with a hanging bloom, a bluebell that quite unexpectedly provides the perfect light.



4635 54 /10. 4625 54 /10.



4625 54 /10. 4635 54 /10. 4640 54 /10.

Brisa

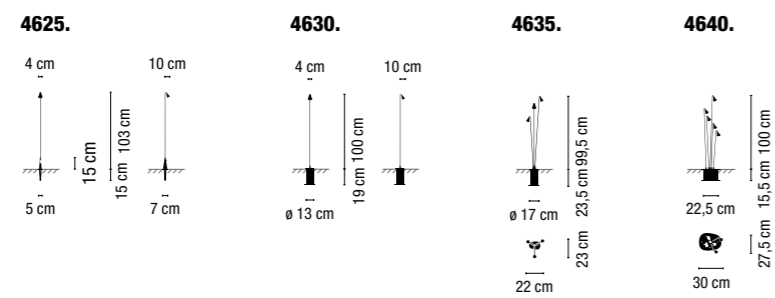

Polycarbonate diffuser / Difusor de policarbonato.

	Surface / Superficie.	4625 07 /10. 4625 54 /10.	Ⓢ 1 x LED 2,1W 700mA.	LED Ⓢ IP64 CE Ⓢ Bi-volt		
	Built-in / Empotrado.	4630 07 /10. 4630 54 /10.	Ⓢ 1 x LED 2,1W 700mA.	LED Ⓢ IP65 CE Ⓢ Bi-volt	<ul style="list-style-type: none"> ● 07 Matt khaki lacquer / Lacado Khaki mate. ● 54 Matt oxide lacquer / Lacado óxido mate. 	/10. 2700 °K. Dimmable: No.
		4635 07 /10. 4635 54 /10.	Ⓢ 3 x LED 2,1W 700mA.			
		4640 07 /10. 4640 54 /10.	Ⓢ 5 x LED 2,1W 700mA.			

Check additional product specifications at the end of this catalogue: Technical information /
Consultar especificaciones adicionales del producto al final del catálogo: Información Técnica.



4640 07 /10. 4630 07 /10. 4635 07 /10.

Bamboo

Design by Antoni Arola & Enric Rodríguez.



When working on projects I always try to use the minimum components possible to achieve the maximum results.



4802 54 /10. 4803 54 /10. 4805 54 /10. 4804 54 /10.



4804 58 /10. 4802 58 /10. 4803 58 /10. 4804 58 /10. 4805 58 /10.

Bamboo



4812 54 /10.



4812 58 /10. 4810 58 /10.



Built-in / Empotrado.

4815 18.

Accessory for the references
4810, 4811 and 4812 to surface installation /
Accesorio de las ref. 4810, 4811 y 4812
para instalar en superficie.



4815 18. 4812 58 /10.

Bamboo

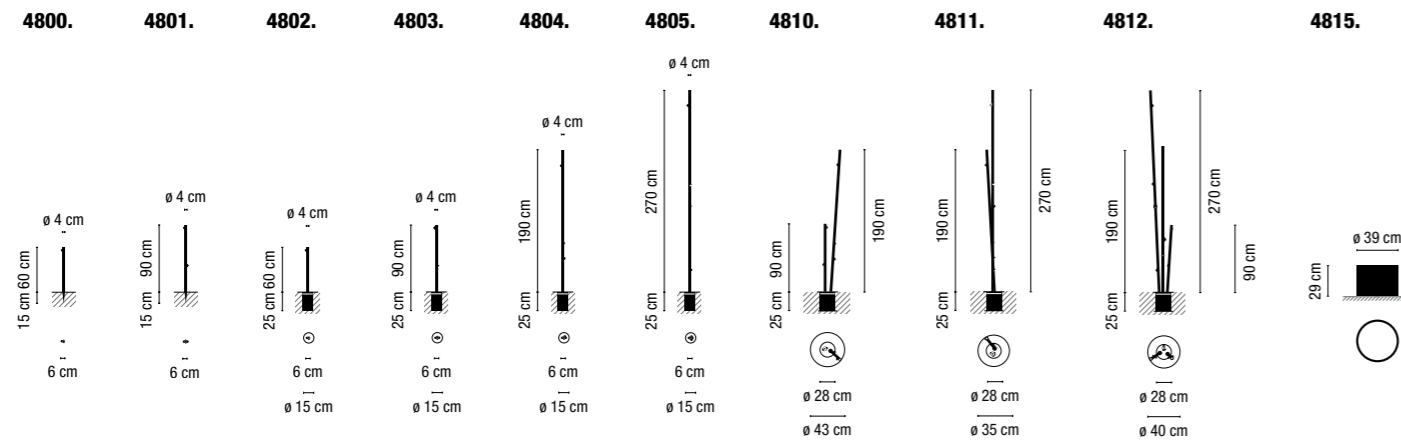

Methacrylate diffuser / Difusor de metacrilato.



Surface / Superficie.	4800 07 /10. 4800 54 /10. 4800 58 /10.	☉ 1 x LED 2,1W 700mA.	<ul style="list-style-type: none"> ● 07 Matt khaki lacquer / Lacado khaki mate. ● 54 Matt oxide lacquer / Lacado óxido mate. ● 58 Off-white matt lacquer / Lacado blanco roto mate. 	/10. 2700 °K. Dimmable: No.
		4801 07 /10. 4801 54 /10. 4801 58 /10.		
Built-in / Empotrado.	4802 07 /10. 4802 54 /10. 4802 58 /10.	☉ 1 x LED 2,1W 700mA.		
	4803 07 /10. 4803 54 /10. 4803 58 /10.	☉ 2 x LED 2,1W 700mA.		
	4804 07 /10. 4804 54 /10. 4804 58 /10.	☉ 3 x LED 2,1W 700mA.		
	4805 07 /10. 4805 54 /10. 4805 58 /10.	☉ 4 x LED 2,1W 700mA.		
	4810 07 /10. 4810 54 /10. 4810 58 /10.	☉ 5 x LED 2,1W 700mA.		
	4811 07 /10. 4811 54 /10. 4811 58 /10.	☉ 7 x LED 2,1W 700mA.		
	4812 07 /10. 4812 54 /10. 4812 58 /10.	☉ 9 x LED 2,1W 700mA.		
Surface installation accessory / Accesorio instalación superficie.	4815 18.	For ref. / Para ref. 4810. 4811. 4812.		

Check additional product specifications at the end of this catalogue: Technical information / Consultar especificaciones adicionales del producto al final del catálogo: Información Técnica.



Surface / Superficie.



Built-in / Empotrado.

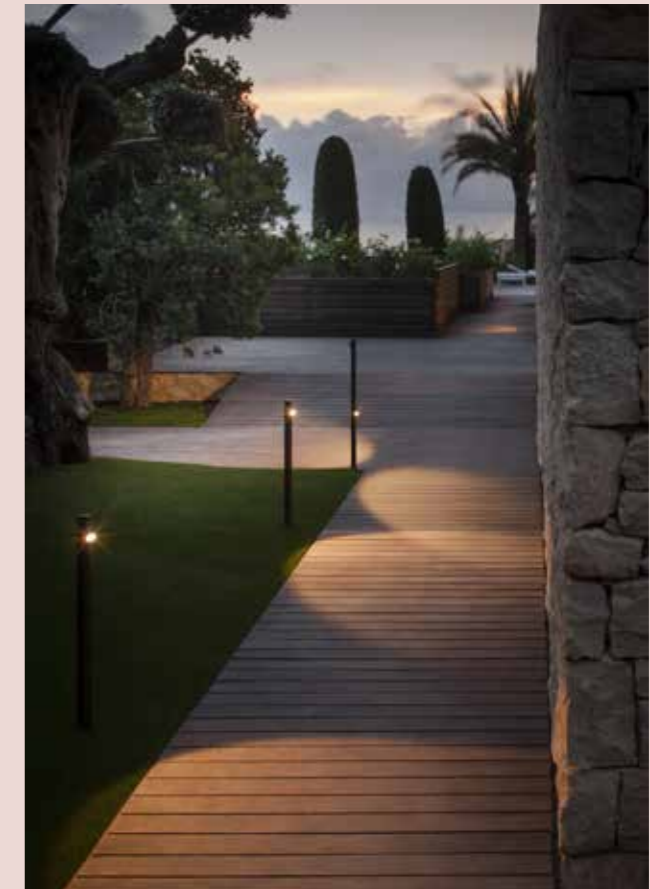

4802 54 /10. 4803 54 /10.



4803 54 /10. 4805 54 /10. 4802 54 /10.

Bamboo



4820.



Methacrylate diffuser / Difusor de metacrilato.



4820 07 /10.
4820 54 /10.
4820 58 /10.

⊙ 1 x LED 2,1W 700mA.

- 07 Matt khaki lacquer / Lacado khaki mate.
- 54 Matt oxide lacquer / Lacado óxido mate.
- 58 Off-white matt lacquer / Lacado blanco roto mate.

/10.
2700 °K.
Dimmable: No.

Surface / Superficie.
Check additional product specifications at the end of this catalogue: Technical information /
Consultar especificaciones adicionales del producto al final del catálogo: Información Técnica.



4820 54 /10.

Boxes

Design by Xuclà.



Three boxes piled one on top of the other, combining aesthetics and functionality with a geometric design to integrate seamlessly within landscapes and outdoor environments.



4600 07.

Boxes

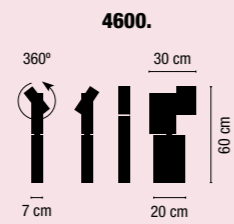

Sandblasted glass diffuser / Difusor de vidrio arenado.



4600 07.
4600 54. 1 x HCl G8,5 20W.

● **07** Matt khaki lacquer / Lacado khaki mate.
● **54** Matt oxide lacquer / Lacado óxido mate.

Check additional product specifications at the end of this catalogue: Technical information /
Consultar especificaciones adicionales del producto al final del catálogo: Información Técnica.



4600 54.

Wind

Design by Jordi Vilardell.



A fresh and contemporary take on the traditional design of lamp shades featuring a groundbreaking manufacturing process.



4060 03.

4070 08. 4075 07.



Wind



4065 08. 4060 03.



4055 03.



4055 03. 4055 08.

Wind

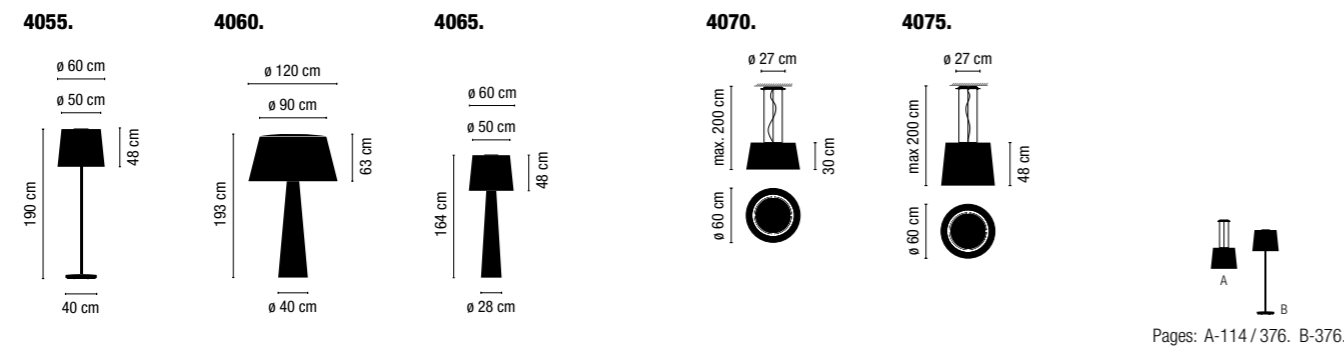

Methacrylate diffuser / Difusor de metacrilato.

<p>4055 03. 4055 04. 4055 07. 4055 08.</p>	<p>○ 1 x 2GX13 230V 40W (T5C)</p>	<p>⚡ IP64 CE</p>	<ul style="list-style-type: none"> ● 03 White fiberglass / Fibra de vidrio blanca. ● 04 Black fiberglass / Fibra de vidrio negra. ● 07 Green fiberglass / Fibra de vidrio verde. ● 08 Orange fiberglass / Fibra de vidrio naranja.
<p>4060 03. 4060 07. 4060 08.</p>	<p>○ 1 x 2GX13 230V 60W (T5C) ⊗ 1 x LED 2,1W 700mA.</p>	<p>LED ⚡ IP64 CE</p>	<ul style="list-style-type: none"> ● 03 White fiberglass / Fibra de vidrio blanca. ● 07 Green fiberglass / Fibra de vidrio verde. ● 08 Orange fiberglass / Fibra de vidrio naranja.
<p>4065 03. 4065 07. 4065 08.</p>	<p>○ 1 x 2GX13 230V 22W (T5C) ⊗ 1 x LED 2,1W 700mA.</p>	<p>LED ⚡ IP64 CE</p>	<ul style="list-style-type: none"> ● 03 White fiberglass / Fibra de vidrio blanca. ● 07 Green fiberglass / Fibra de vidrio verde. ● 08 Orange fiberglass / Fibra de vidrio naranja.
<p>4070 03. 4075 03. 4070 04. 4075 04. 4070 07. 4075 07. 4070 08. 4075 08.</p>	<p>○ 1 x 2GX13 230V 40W (T5C).</p>	<p>⚡ IP65 CE</p>	<ul style="list-style-type: none"> ● 03 White fiberglass / Fibra de vidrio blanca. ● 04 Black fiberglass / Fibra de vidrio negra. ● 07 Green fiberglass / Fibra de vidrio verde. ● 08 Orange fiberglass / Fibra de vidrio naranja.

Check additional product specifications at the end of this catalogue: Technical information / Consultar especificaciones adicionales del producto al final del catálogo: Información Técnica.



4075 03.

Break

Design by Xuclà & Alemany.



Designed to delight, surprise and stimulate the senses.
An outdoor light that could equally be read as sculpture.



4106 54 /10. 4101 54 /10.



4108 54 /10.





4101 80 /10.

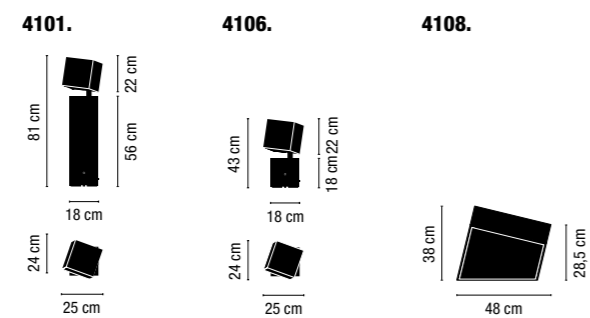
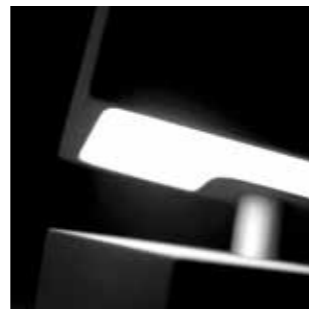

Break



4108 54 /10.

Methacrylate diffuser / Difusor de metacrilato.	4108 07 /10. 4108 54 /10.	2 x LED STRIP 11,6W 350mA.	IP65 CE	<ul style="list-style-type: none"> 07 Khaki lacquer / Lacado khaki. 54 Oxide lacquer / Lacado óxido. 	/10. 2700 °K. Dimmable: No.
Polycarbonate diffuser / Difusor de policarbonato.	4101 07 /10. 4106 07 /10. 4101 54 /10. 4106 54 /10. 4101 80 /10. 4106 80 /10.	1 x LED 6,2W 350mA.	LED IP66 CE Bi-volt	<ul style="list-style-type: none"> 07 Khaki lacquer / Lacado kaki. 54 Oxide lacquer / Lacado óxido. 80 Concrete / Hormigón. 	

Check additional product specifications at the end of this catalogue: Technical information / Consultar especificaciones adicionales del producto al final del catálogo: Información Técnica.

Break



4110.



Methacrylate diffuser / Difusor de metacrilato.



4110 07 /10.
4110 54 /10.
4110 80 /10.

⊙ 1 x LED 2,1W 700mA.

- **07** Khaki lacquer / Lacado kaki.
- **54** Oxide lacquer / Lacado óxido.
- **80** Concrete / Hormigón.

/10.
 2700 °K.
 Dimmable: No.

Check additional product specifications at the end of this catalogue: Technical information /
 Consultar especificaciones adicionales del producto al final del catálogo: Información Técnica.



4110 80 /10.



4110 54 /10.

Halley

Design by Jordi Vilardell & Merixell Vidal.

Halley's light is like a new comet passing over head: its arched beam generates a sculptural light cutting through the night to create a magical, warm and inviting atmosphere.



4150 04.



4150 04.

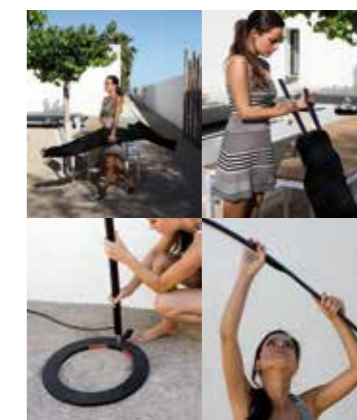

Easy assembly in any place

HALLEY is easy to move, assemble and disassemble, allowing it to be placed anywhere in a fast and simple way you want, with adjustable brightness.

Instalar fácilmente en cualquier rincón

HALLEY es de fácil transporte, montaje y desmontaje, permitiendo su instalación en cualquier rincón de forma rápida y sencilla.

4150.

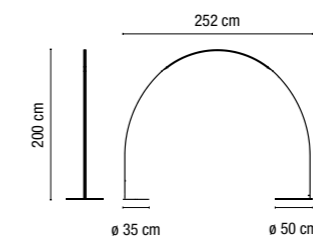

Polycarbonate diffuser / Difusor de policarbonato.

LED IP64 CE

4150 04. 1 x LED STRIP 24V 21,6W.

04 Black / Negro.

Check additional product specifications at the end of this catalogue: Technical information / Consultar especificaciones adicionales del producto al final del catálogo: Información Técnica.

Plus

Design by X. Claramunt & M. de Mas.



Plus is a "skylight" concept for the ceiling, providing a solution for creating a natural daylight atmosphere.



0630 03.



0630. 0631.

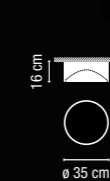

0635. 0636.

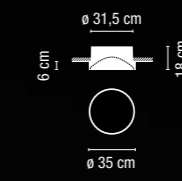

Pages: A-246. B-246 / 392.

Methacrylate diffuser / Difusor de metacrilato.



Dimmable version: electronic ballast (DALI System or push) / Versión regulable: reactancia electrónica (Sistema DALI o pulsador).	Surface fitting / Superficie.	0630 03.		1 x 2GX13 230V 55W (T5C).	03 Matt white lacquer / Lacado blanco mate.
	Semi built-in / Semi empotrado.	0635 03.	 ø 32,8 cm		
Surface fitting / Superficie.	0631 03.				
Semi built-in / Semi empotrado.	0636 03.	 ø 32,8 cm			

Check additional product specifications at the end of this catalogue: Technical information /
Consultar especificaciones adicionales del producto al final del catálogo: Información Técnica.

Micro

Design by Ramos & Bassols.

Like an eclipse, just at that moment when the moon passes over the sun leaving only a ring of light.



2015 03.



2015 54.



2015 03 /10.



2015 54 /10.

2015.

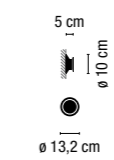

Pages: A-298 / 394.

Polycarbonate diffuser / Difusor de policarbonato.



2015 03 /10.
2015 54 /10.

Ⓢ 3 x LED 1W 350mA.

03 White lacquer / Lacado blanco.
54 Oxide lacquer / Lacado óxido.

/10.
2700 °K.
Dimmable: No.

Surface fitting / Superficie.
Check additional product specifications at the end of this catalogue: Technical information /
Consultar especificaciones adicionales del producto al final del catálogo: Información Técnica.

Plis Outdoor

Design by Ramos & Bassols.



A surprising design which brings the warm atmosphere and textures of the indoors to the garden, terrace or porch. Breaking down boundaries between inside and outside.



4040 03.



4030 03.



Top and bottom disc /
Disco superior e inferior.

Plis Outdoor

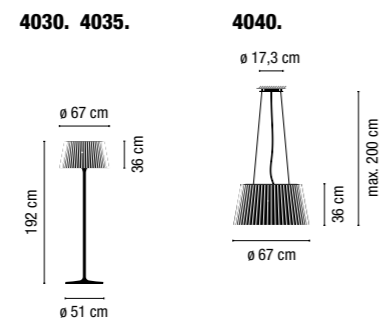

Polyethylene diffuser / Difusor de polietileno.

White canopy / Florón blanco.		4040 03.			
Portable version. Surface cable / Versión portátil. Cable en superficie.		4030 03.		2 x COMPACT FLUORESCENT E27 230V 23W.	03 White lacquer / Lacado blanco.
Built-in cable / Cable empotrado.		4035 03.			

Check additional product specifications at the end of this catalogue: Technical information /
Consultar especificaciones adicionales del producto al final del catálogo: Información Técnica.



4030 30. 4040 03.



4035 03. 4030 03.

Scotch

Design by Oscar & Sergi Devesa.

Rounded transparent glass featuring a very soft and pleasing profile, almost imperceptible.



0962.

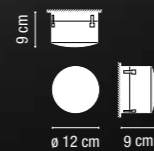

Pages: 262 / 330 / 400.

Pressed-glass diffuser / Difusor de vidrio prensado.



0962 01 /10.

1 x LED PLATE 3W 350mA.

01 Chrome / Cromo.

/10.
2700 °K.
Dimmable: No.

Check additional product specifications at the end of this catalogue: Technical information /
Consultar especificaciones adicionales del producto al final del catálogo: Información Técnica.



Tree

Design by Pete Sans.



While the chameleon adopts the camouflage of its surroundings by mimicking its colours the Tree lamp adopts the forms of shrubs and vegetation to subtly blend with the garden.



4005 03. 4015 03.



4015 14. 4010 14. 4005 03. 4000 03.



4010 03. 4000 03.



4010 03. 4000 03.

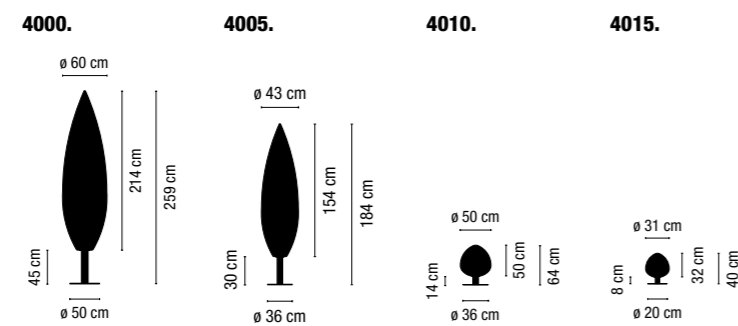

Polyethylene diffuser / Difusor de polietileno.

<p>Installation: The product can be installed with an in-ground cable (IP65) or a surface cable (IP64) /</p> <p>Instalación: El producto puede instalarse con cable empotrado (IP65) o con cable de superficie (IP64).</p>	<p>4000 03. 4000 14.</p>	<p>2 x 2G11 230V 36W.</p>	<p>IP64 CE</p>	<p>03 White lacquer / Lacado blanco. 14 Oxide brown lacquer / Lacado marrón óxido.</p>
	<p>4005 03. 4005 14.</p>	<p>2 x 2G11 230V 24W.</p>		
	<p>4010 03. 4010 14.</p>	<p>1 x COMPACT FLUORESCENT E27 230V 20W.</p>	<p>IP64 CE Bi-volt</p>	
	<p>4015 03. 4015 14.</p>	<p>1 x COMPACT FLUORESCENT E27 230V 15W.</p>		

Check additional product specifications at the end of this catalogue: Technical information / Consultar especificaciones adicionales del producto al final del catálogo: Información Técnica.

Palo Alto

Design by Xuclà.



The visual language is based on the abstracted tree branch.
The irregular branch gives us the shape.



4510 54. 4515 54. 4520 54. 4525 54. 4630 54.



4535 54. 4536 54.



4515 07.



4536 54.



4510 54.

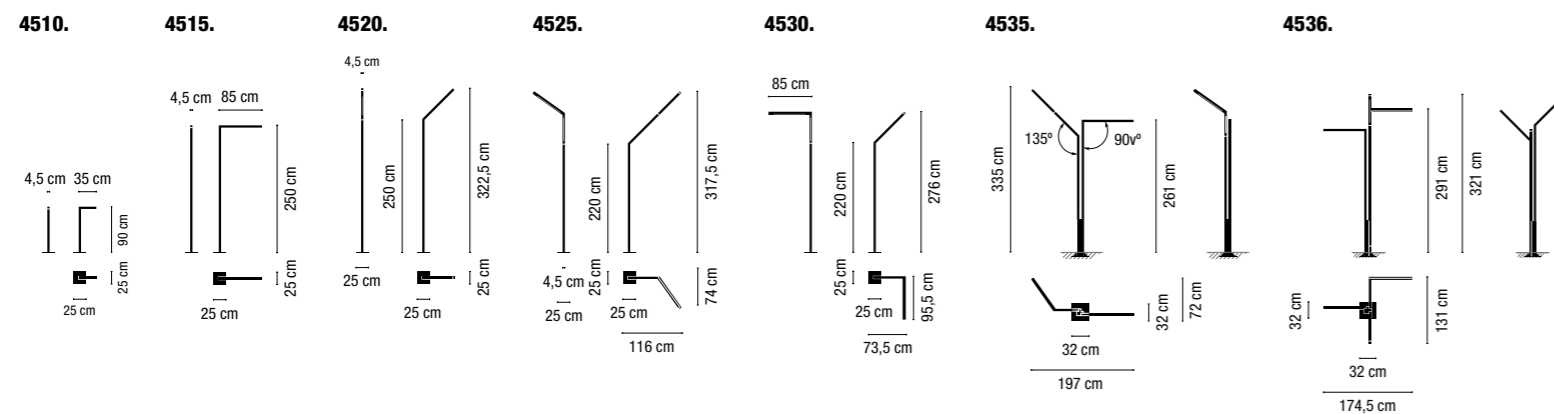

Polycarbonate diffuser / Difusor de policarbonato.

4510 07. 4510 54.	☉ 1 x LED 2,1W 700mA.	LED IP65 CE	<ul style="list-style-type: none"> ● 07 Matt khaki lacquer / Lacado khaki mate. ● 54 Matt oxide lacquer / Lacado óxido mate.
4515 07. 4520 07. 4515 54. 4520 54.	▬ 1 x LED STRIP 24V 10W.	LED IP65 CE Bi-volt	
4525 07. 4530 07. 4525 54. 4530 54.	▬ 2 x LED STRIP 24V 10W.		
4535 07. 4535 54.	▬ 3 x LED STRIP 24V 10W.		
4536 07. 4536 54.	▬ 4 x LED STRIP 24V 10W.		

Check additional product specifications at the end of this catalogue: Technical information / Consultar especificaciones adicionales del producto al final del catálogo: Información Técnica.

Origami

Design by Ramón Esteve.



Origami blends light functionality with an opportunity for artistic creation. Like a luminous creeper plant.

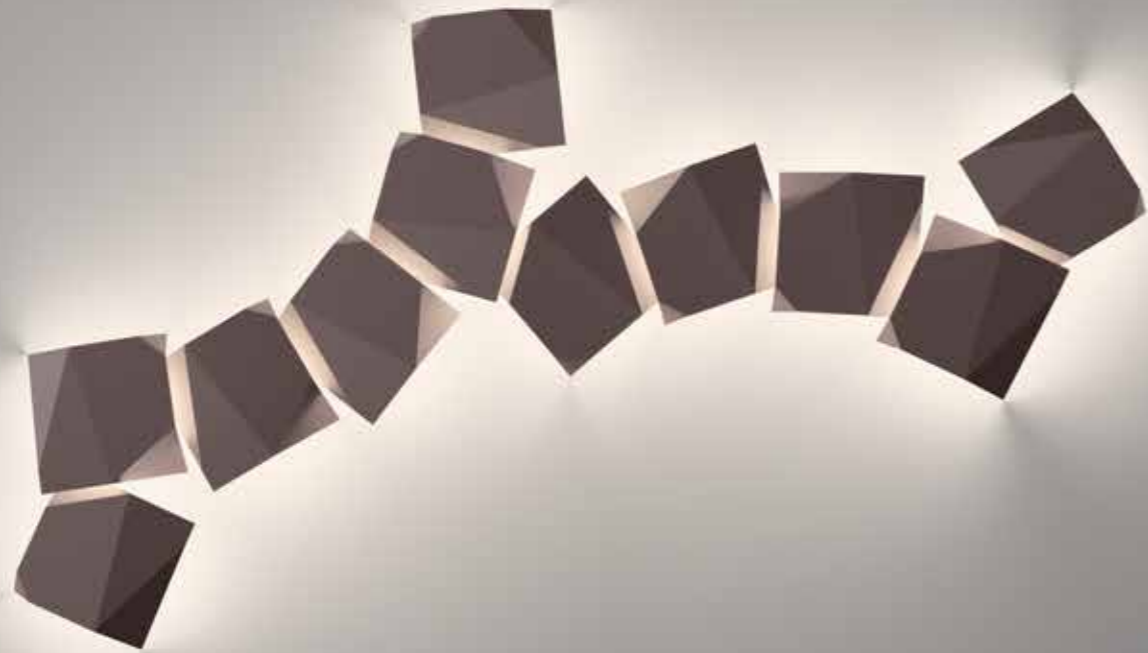

Origami

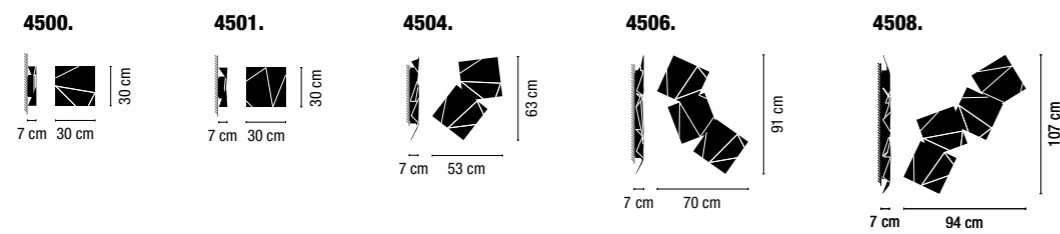

Pages: 288 / 410.

Policarbonate difuser / Difusor de policarbonato.



4500 03 /14. 4501 03 /14. 4500 07 /14. 4501 07 /14. 4500 54 /14. 4501 54 /14.	1 x LED STRIP 6,5W 350mA.	<ul style="list-style-type: none"> 03 Matt white lacquer / Lacado blanco mate. 07 Green oxide lacquer / Lacado verde óxido. 54 Oxide lacquer / Lacado óxido. 	/14. 2700 °K. Dimmable: TRIAC.
4504 03 /14. 4504 07 /14. 4504 54 /14.	2 x LED STRIP 6,5W 350mA.		
4506 03 /14. 4506 07 /14. 4506 54 /14.	3 x LED STRIP 6,5W 350mA.		
4508 03 /14. 4508 07 /14. 4508 54 /14.	4 x LED STRIP 6,5W 350mA.		

Check additional product specifications at the end of this catalogue: Technical information / Consultar especificaciones adicionales del producto al final del catálogo: Información Técnica.



Wall Arts

With only two designs you can create artistic layouts on the wall. With a single power connection point and no need for inseting you can create whatever light murals you want, with adjustable brightness.

Wall Arts

Con sólo dos diseños pueden crearse configuraciones artísticas en la pared. Con un único punto de conexión eléctrica y sin necesidad de empotramiento, se pueden crear los murales luminosos que se desee, de intensidad luminica regulable.



Create your product configuration quickly and easily at vibia.com

Go to vibia.com and discover the quickest, most efficient way to configure a unique lighting mural with Origami.

Crea tu configuración de producto rápido y fácil en vibia.com

Entra en vibia.com y descubre la manera más rápida y eficiente de configurar un mural luminoso único con Origami.



Empty

Design by Xuclà.

Empty can be completely integrated within outdoor spaces thanks to its clean silhouette and geometric lines, combining the functions of lantern and outdoor furniture, a catalyst for moments of relaxation and calm.

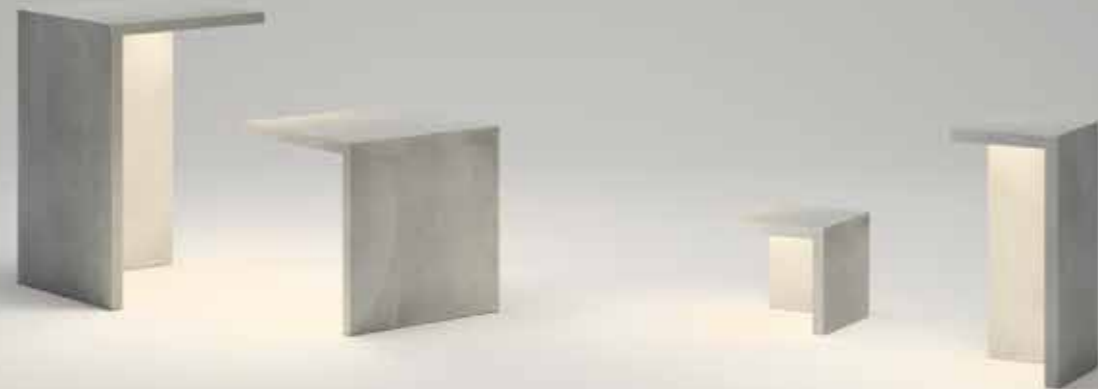

4130 18 /30. 4125 18 /30. 4135 58 /30. 4136 58 /30.



Empty



4130 18 /30. 4125 18 /30.

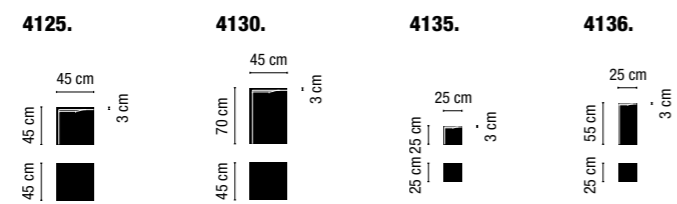

Acrylic diffuser / Difusor de metacrilato.



<p>4125 18 /30. 4130 18 /30.</p> <p>----- 2 x LED STRIP 24V 8,6W.</p>	<p>● 18 Grey polymer concrete / Hormigón polímero gris.</p>	<p>/30. 3500 °K. Dimmable: No.</p>
<p>4135 18 /30. 4136 18 /30.</p> <p>----- 2 x LED STRIP 24V 4,3W.</p>		

Check additional product specifications at the end of this catalogue: Technical information / Consultar especificaciones adicionales del producto al final del catálogo: Información Técnica.

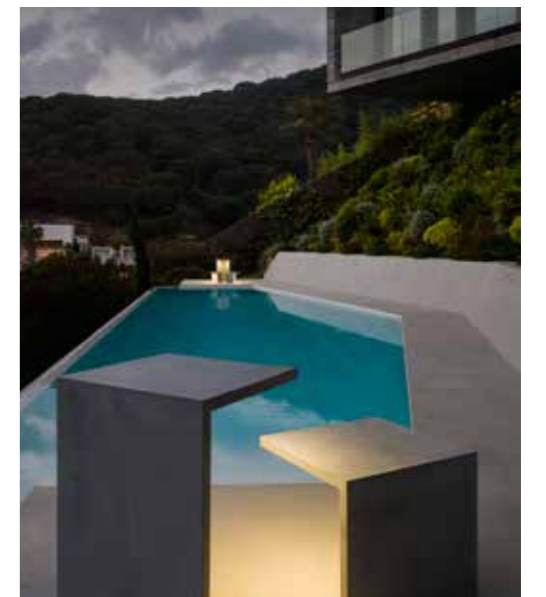

4130 18 /30. 4125 18 /30.

Meridiano

Design by Jordi Vilardell & Merixell Vidal.



Meridiano is pure emotion, an attitude to space, a playful interpretation of outdoor furniture and lighting and the enjoyment of nature.





4720.



Surface mounted wall lamp /
Aplique instalado en superficie.

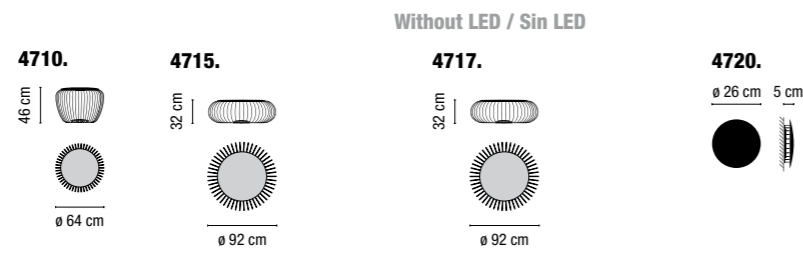

Glass diffuser / Difusor de vidrio.	4710 07 /10. 4715 07 /10. 4710 58 /10. 4715 58 /10. 4710 62 /10. 4715 62 /10.	Ⓢ 1 x LED 7,7W 700mA.	LED Ⓢ IP64 CE Ⓢ Bi-volt	<ul style="list-style-type: none"> ● 07 Matt khaki lacquer / Lacado khaki mate. ● 58 Off-white matt lacquer / Lacado blanco roto mate. ● 62 Matt green lacquer / Lacado verde mate. 	/10. 2700 °K. Dimmable: No.
	4717 07. 4717 58. 4717 62.	Without LED / Sin LED			
Policarbonate diffuser / Difusor de policarbonato.	4720 07 /10. 4720 58 /10. 4720 62 /10.	Ⓢ 1 x LED 7,7W 700mA.	LED Ⓢ IP65 CE Ⓢ Bi-volt		

Check additional product specifications at the end of this catalogue: Technical information /
Consultar especificaciones adicionales del producto al final del catálogo: Información Técnica.





Professional Area at vibia.com / Área Profesional en vibia.com

A new way of Working

We believe in **cooperation** and we bring you new ways to **collaborate** and online tools at **vibia.com** that we will help to work together efficiently. We propose a new way of working to have successful lighting projects.

Una nueva manera de Trabajar

Creemos en la **cooperación**, por eso te proponemos nuevas formas de **colaboración** y te brindamos nuevas herramientas online en **vibia.com** que nos ayudarán a trabajar juntos de un modo mucho más eficiente, para que tus proyectos de iluminación sean un éxito.

Download all the information you need

Check and download all product information you need for your projects in one click:

Descarga toda la información que necesitas

Consulta y descarga toda la información actualizada de producto que necesites para tus proyectos en un solo clic:



Spec sheet /
Ficha técnica.

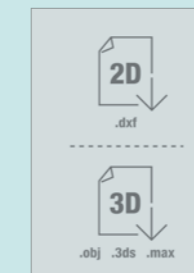

2D, 3D /
2D, 3D.

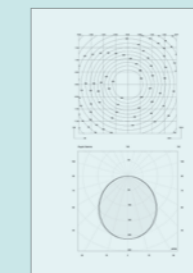

Photometry /
Fotometrías.



HD images /
Fotos en alta resolución.

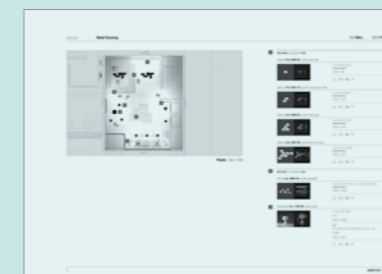

Project report /
Memoria de proyecto.



Product lists /
Listas de productos.



Product configuration
spec sheet /
Ficha de creación.



Installation instructions /
Manual de instalación.

Product specifications subject to change without notice.
Please check vibia.com for updated information.

	Item	Materials	Finish	Ral / Pantone	Led	Driver Included	
Algorithm	0820 18 /1A	Ball: Blowed glass Glass fixation: Aluminum Ceiling rose: Steel	Diffuser: PC Hanging structure: Steel	Matt graphite lacquer	ADAPTA RF9913WX	2760 K. CRI >80. 137,2 lm. 43,5 lm/W.	Constant Current 1050 mA. 100-240V. 50/60Hz.
	0820 93 /1A	Ball: Blowed glass Glass fixation: Aluminum Ceiling rose: Steel	Diffuser: PC Hanging structure: Steel	Matt white lacquer	RAL 9016	2760 K. CRI >80. 137,2 lm. 43,5 lm/W.	Constant Current 1050 mA. 100-240V. 50/60Hz.
	0825 18 /1A	Ball: Blowed glass Glass fixation: Aluminum Ceiling rose: Steel	Diffuser: PC Hanging structure: Steel	Matt graphite lacquer	ADAPTA RF9913WX	2760 K. CRI >80. 1372,4 lm. 43,5 lm/W.	Constant Current 1050 mA. 100-240V. 50/60Hz.
	0825 93 /1A	Ball: Blowed glass Glass fixation: Aluminum Ceiling rose: Steel	Diffuser: PC Hanging structure: Steel	Matt white lacquer	RAL 9016	2760 K. CRI >80. 1372,4 lm. 43,5 lm/W.	Constant Current 1050 mA. 100-240V. 50/60Hz.
	0830 18 /1A	Ball: Blowed glass Glass fixation: Aluminum Ceiling rose: Steel	Diffuser: PC Hanging structure: Steel	Matt graphite lacquer	ADAPTA RF9913WX	2760 K. CRI >80. 823,4 lm. 43,5 lm/W.	Constant Current 1050 mA. 100-240V. 50/60Hz.
	0830 93 /1A	Ball: Blowed glass Glass fixation: Aluminum Ceiling rose: Steel	Diffuser: PC Hanging structure: Steel	Matt white lacquer	RAL 9016	2760 K. CRI >80. 823,4 lm. 43,5 lm/W.	Constant Current 1050 mA. 100-240V. 50/60Hz.
	0835 18 /1A	Ball: Blowed glass Glass fixation: Aluminum Ceiling rose: Steel	Diffuser: PC Hanging structure: Steel	Matt graphite lacquer	ADAPTA RF9913WX	2760 K. CRI >80. 1372,4 lm. 43,5 lm/W.	Constant Current 1050 mA. 100-240V. 50/60Hz.
	0835 93 /1A	Ball: Blowed glass Glass fixation: Aluminum Ceiling rose: Steel	Diffuser: PC Hanging structure: Steel	Matt white lacquer	RAL 9016	2760 K. CRI >80. 1372,4 lm. 43,5 lm/W.	Constant Current 1050 mA. 100-240V. 50/60Hz.
	0840 18 /1A	Ball: Blowed glass Glass fixation: Aluminum Ceiling rose: Steel	Diffuser: PC Hanging structure: Steel	Matt graphite lacquer	ADAPTA RF9913WX	2760 K. CRI >80. 1921,4 lm. 43,5 lm/W.	Constant Current 1050 mA. 100-240V. 50/60Hz.
	0840 93 /1A	Ball: Blowed glass Glass fixation: Aluminum Ceiling rose: Steel	Diffuser: PC Hanging structure: Steel	Matt white lacquer	RAL 9016	2760 K. CRI >80. 1921,4 lm. 43,5 lm/W.	Constant Current 1050 mA. 100-240V. 50/60Hz.
	0845 18 /1A	Ball: Blowed glass Glass fixation: Aluminum Ceiling rose: Steel	Diffuser: PC Hanging structure: Steel	Matt graphite lacquer	ADAPTA RF9913WX	2760 K. CRI >80. 1921,4 lm. 43,5 lm/W.	Constant Current 1050 mA. 100-240V. 50/60Hz.
	0845 93 /1A	Ball: Blowed glass Glass fixation: Aluminum Ceiling rose: Steel	Diffuser: PC Hanging structure: Steel	Matt white lacquer	RAL 9016	2760 K. CRI >80. 1921,4 lm. 43,5 lm/W.	Constant Current 1050 mA. 100-240V. 50/60Hz.
	0850 18 /1A	Ball: Blowed glass Glass fixation: Aluminum Ceiling rose: Steel	Diffuser: PC Hanging structure: Steel	Matt graphite lacquer	ADAPTA RF9913WX	2760 K. CRI >80. 3980,1 lm. 43,5 lm/W.	Constant Current 1050 mA. 100-240V. 50/60Hz.
	0850 93 /1A	Ball: Blowed glass Glass fixation: Aluminum Ceiling rose: Steel	Diffuser: PC Hanging structure: Steel	Matt white lacquer	RAL 9016	2760 K. CRI >80. 3980,1 lm. 43,5 lm/W.	Constant Current 1050 mA. 100-240V. 50/60Hz.
	0855 18 /1A	Ball: Blowed glass Glass fixation: Aluminum Ceiling rose: Steel	Diffuser: PC Hanging structure: Steel	Matt graphite lacquer	ADAPTA RF9913WX	2760 K. CRI >80. 686,2 lm. 43,5 lm/W.	Constant Current 1050 mA. 100-240V. 50/60Hz.
	0855 93 /1A	Ball: Blowed glass Glass fixation: Aluminum Ceiling rose: Steel	Diffuser: PC Hanging structure: Steel	Matt white lacquer	RAL 9016	2760 K. CRI >80. 686,2 lm. 43,5 lm/W.	Constant Current 1050 mA. 100-240V. 50/60Hz.
	0860 18 /1A	Ball: Blowed glass Glass fixation: Aluminum Ceiling rose: Steel	Diffuser: PC Hanging structure: Steel	Matt graphite lacquer	ADAPTA RF9913WX	2760 K. CRI >80. 1784,1 lm. 43,5 lm/W.	Constant Current 1050 mA. 100-240V. 50/60Hz.
	0860 93 /1A	Ball: Blowed glass Glass fixation: Aluminum Ceiling rose: Steel	Diffuser: PC Hanging structure: Steel	Matt white lacquer	RAL 9016	2760 K. CRI >80. 1784,1 lm. 43,5 lm/W.	Constant Current 1050 mA. 100-240V. 50/60Hz.
0865 18 /1A	Ball: Blowed glass Glass fixation: Aluminum Ceiling rose: Steel	Diffuser: PC Hanging structure: Steel	Matt graphite lacquer	ADAPTA RF9913WX	2760 K. CRI >80. 3431,1 lm. 43,5 lm/W.	Constant Current 1050 mA. 100-240V. 50/60Hz.	

Technical information

Item	Materials	Finish	Ral / Pantone	Led	Driver Included
2216 18	Body: Polyurethane foam Diffuser: Methacrylate	Graphite grey	RAL 7016	—	—
2220 03	Body: Polyurethane foam Diffuser: Methacrylate	Matt white lacquer	RAL 9010	—	—
2220 18	Body: Polyurethane foam Diffuser: Methacrylate	Graphite grey	RAL 7016	—	—
2221 03	Body: Polyurethane foam Diffuser: Methacrylate	Matt white lacquer	RAL 9010	—	—
2221 18	Body: Polyurethane foam Diffuser: Methacrylate	Graphite grey	RAL 7016	—	—
2225 01	Canopy Plate: Steel	Chrome	Metallic finish	—	—
2226 01	Canopy Plate: Steel	Chrome	Metallic finish	—	—
2230 03	Body: Polyurethane foam Diffuser: Methacrylate	Matt white lacquer	RAL 9010	—	—
2230 18	Body: Polyurethane foam Diffuser: Methacrylate	Graphite grey	RAL 7016	—	—
Balance					
5189 01	Vertical tube: Aluminum Base: Steel Arm: Inox Shade: Aluminum-weft	Chrome	Metallic finish	—	—
5189 18	Vertical tube: Aluminum Base: Steel Arm: Inox Shade: Aluminum-weft	Graphite grey	RAL 7016	—	—
5189 30	Vertical tube: Aluminum Base: Steel Arm: Inox Shade: Aluminum-weft	Matt nickel	Metallic finish	—	—
5190 01	Vertical tube: Aluminum Base: Steel Arm: Inox Shade: Cotton	Chrome	Metallic finish	—	—
5190 30	Vertical tube: Aluminum Base: Steel Arm: Inox Shade: Cotton	Matt nickel	Metallic finish	—	—
5191 01	Vertical tube: Aluminum Base: Steel Arm: Inox Shade: Cotton	Chrome	Metallic finish	—	—
5191 30	Vertical tube: Aluminum Base: Steel Arm: Inox Shade: Cotton	Matt nickel	Metallic finish	—	—
5192 01	Vertical tube: Aluminum Base: Steel Arm: Inox Shade: Aluminum-weft	Chrome	Metallic finish	—	—
5192 18	Vertical tube: Aluminum Base: Steel Arm: Inox Shade: Aluminum-weft	Matt graphite lacquer	RAL 7016	—	—
5192 30	Vertical tube: Aluminum Base: Steel Arm: Inox Shade: Aluminum-weft	Matt nickel	Metallic finish	—	—
Bamboo					
4800 07 /10	Cane: Resin + fiberglass Diffuser: Methacrylate	Khaki lacquer	RAL 7006	2700 K. CRI >80. 199,3 lm. 94,9 lm/W.	Constant Current 700 mA. 100-240V. 50/60Hz.
4800 54 /10	Cane: Resin + fiberglass Diffuser: Methacrylate	Oxide-brown lacquer	RAL 8017	2700 K. CRI >80. 199,3 lm. 94,9 lm/W.	Constant Current 700 mA. 100-240V. 50/60Hz.
4800 58 /10	Cane: Resin + fiberglass Diffuser: Methacrylate	Off-white matt lacquer	PANTONE WARM GRAY 2U	2700 K. CRI >80. 199,3 lm. 94,9 lm/W.	Constant Current 700 mA. 100-240V. 50/60Hz.
4801 07 /10	Cane: Resin + fiberglass Diffuser: Methacrylate	Khaki lacquer	RAL 7006	2700 K. CRI >80. 398,6 lm. 94,9 lm/W.	Constant Current 700 mA. 100-240V. 50/60Hz.
4801 54 /10	Cane: Resin + fiberglass Diffuser: Methacrylate	Oxide-brown lacquer	RAL 8017	2700 K. CRI >80. 398,6 lm. 94,9 lm/W.	Constant Current 700 mA. 100-240V. 50/60Hz.
4801 58 /10	Cane: Resin + fiberglass Diffuser: Methacrylate	Off-white matt lacquer	PANTONE WARM GRAY 2U	2700 K. CRI >80. 398,6 lm. 94,9 lm/W.	Constant Current 700 mA. 100-240V. 50/60Hz.
4802 07 /10	Cane: Resin + fiberglass Diffuser: Methacrylate	Khaki lacquer	RAL 7006	2700 K. CRI >80. 199,3 lm. 94,9 lm/W.	Constant Current 700 mA. 100-240V. 50/60Hz.
4802 54 /10	Cane: Resin + fiberglass Diffuser: Methacrylate	Oxide-brown lacquer	RAL 8017	2700 K. CRI >80. 199,3 lm. 94,9 lm/W.	Constant Current 700 mA. 100-240V. 50/60Hz.

Item	Materials	Finish	Ral / Pantone	Led	Driver Included
4802 58 /10	Cane: Resin + fiberglass Diffuser: Methacrylate	Off-white matt lacquer	PANTONE WARM GRAY 2U	2700 K. CRI >80. 199,3 lm. 94,9 lm/W.	Constant Current 700 mA. 100-240V. 50/60Hz.
4803 07 /10	Cane: Resin + fiberglass Diffuser: Methacrylate	Khaki lacquer	RAL 7006	2700 K. CRI >80. 398,6 lm. 94,9 lm/W.	Constant Current 700 mA. 100-240V. 50/60Hz.
4803 54 /10	Cane: Resin + fiberglass Diffuser: Methacrylate	Oxide-brown lacquer	RAL 8017	2700 K. CRI >80. 398,6 lm. 94,9 lm/W.	Constant Current 700 mA. 100-240V. 50/60Hz.
4803 58 /10	Cane: Resin + fiberglass Diffuser: Methacrylate	Off-white matt lacquer	PANTONE WARM GRAY 2U	2700 K. CRI >80. 398,6 lm. 94,9 lm/W.	Constant Current 700 mA. 100-240V. 50/60Hz.
4804 07 /10	Cane: Resin + fiberglass Diffuser: Methacrylate	Khaki lacquer	RAL 7006	2700 K. CRI >80. 597,9 lm. 94,9 lm/W.	Constant Current 700 mA. 100-240V. 50/60Hz.
4804 54 /10	Cane: Resin + fiberglass Diffuser: Methacrylate	Oxide-brown lacquer	RAL 8017	2700 K. CRI >80. 597,9 lm. 94,9 lm/W.	Constant Current 700 mA. 100-240V. 50/60Hz.
4804 58 /10	Cane: Resin + fiberglass Diffuser: Methacrylate	Off-white matt lacquer	PANTONE WARM GRAY 2U	2700 K. CRI >80. 597,9 lm. 94,9 lm/W.	Constant Current 700 mA. 100-240V. 50/60Hz.
4805 07 /10	Cane: Resin + fiberglass Diffuser: Methacrylate	Khaki lacquer	RAL 7006	2700 K. CRI >80. 797,2 lm. 94,9 lm/W.	Constant Current 700 mA. 100-240V. 50/60Hz.
4805 54 /10	Cane: Resin + fiberglass Diffuser: Methacrylate	Oxide-brown lacquer	RAL 8017	2700 K. CRI >80. 797,2 lm. 94,9 lm/W.	Constant Current 700 mA. 100-240V. 50/60Hz.
4805 58 /10	Cane: Resin + fiberglass Diffuser: Methacrylate	Off-white matt lacquer	PANTONE WARM GRAY 2U	2700 K. CRI >80. 797,2 lm. 94,9 lm/W.	Constant Current 700 mA. 100-240V. 50/60Hz.
4810 07 /10	Cane: Resin + fiberglass Diffuser: Methacrylate	Khaki lacquer	RAL 7006	2700 K. CRI >80. 996,5 lm. 94,9 lm/W.	Constant Current 700 mA. 100-240V. 50/60Hz.
4810 54 /10	Cane: Resin + fiberglass Diffuser: Methacrylate	Oxide-brown lacquer	RAL 8017	2700 K. CRI >80. 996,5 lm. 94,9 lm/W.	Constant Current 700 mA. 100-240V. 50/60Hz.
4810 58 /10	Cane: Resin + fiberglass Diffuser: Methacrylate	Off-white matt lacquer	PANTONE WARM GRAY 2U	2700 K. CRI >80. 996,5 lm. 94,9 lm/W.	Constant Current 700 mA. 100-240V. 50/60Hz.
4811 07 /10	Cane: Resin + fiberglass Diffuser: Methacrylate	Khaki lacquer	RAL 7006	2700 K. CRI >80. 1395 lm. 94,9 lm/W.	Constant Current 700 mA. 100-240V. 50/60Hz.
4811 54 /10	Cane: Resin + fiberglass Diffuser: Methacrylate	Oxide-brown lacquer	RAL 8017	2700 K. CRI >80. 1395 lm. 94,9 lm/W.	Constant Current 700 mA. 100-240V. 50/60Hz.
4811 58 /10	Cane: Resin + fiberglass Diffuser: Methacrylate	Off-white matt lacquer	PANTONE WARM GRAY 2U	2700 K. CRI >80. 1395 lm. 94,9 lm/W.	Constant Current 700 mA. 100-240V. 50/60Hz.
4812 07 /10	Cane: Resin + fiberglass Diffuser: Methacrylate	Khaki lacquer	RAL 7006	2700 K. CRI >80. 1793,6 lm. 94,9 lm/W.	Constant Current 700 mA. 100-240V. 50/60Hz.
4812 54 /10	Cane: Resin + fiberglass Diffuser: Methacrylate	Oxide-brown lacquer	RAL 8017	2700 K. CRI >80. 1793,6 lm. 94,9 lm/W.	Constant Current 700 mA. 100-240V. 50/60Hz.
4812 58 /10	Cane: Resin + fiberglass Diffuser: Methacrylate	Off-white matt lacquer	PANTONE WARM GRAY 2U	2700 K. CRI >80. 1793,6 lm. 94,9 lm/W.	Constant Current 700 mA. 100-240V. 50/60Hz.
4815 18	Base: Concrete Diffuser: Methacrylate	Whitey polymer concrete	RAL 7040	—	—
4820 07 /10	Cane: Resin + fiberglass Diffuser: Methacrylate	Khaki lacquer	RAL 7006	2700 K. CRI >80. 199,3 lm. 94,9 lm/W.	Constant Current 700 mA. 100-240V. 50/60Hz.
4820 54 /10	Cane: Resin + fiberglass Diffuser: Methacrylate	Oxide-brown lacquer	RAL 8017	2700 K. CRI >80. 199,3 lm. 94,9 lm/W.	Constant Current 700 mA. 100-240V. 50/60Hz.
4820 58 /10	Cane: Resin + fiberglass Diffuser: Methacrylate	Off-white matt lacquer	PANTONE WARM GRAY 2U	2700 K. CRI >80. 199,3 lm. 94,9 lm/W.	Constant Current 700 mA. 100-240V. 50/60Hz.
Big					
0530 01	Shade: Methacrylate Ring: Steel	Chrome	Metallic finish	—	—
0530 93	Shade: Methacrylate Ring: Steel	Matt white lacquer	RAL 9010	—	—
0531 01	Shade: Methacrylate Ring: Steel	Chrome	Metallic finish	—	—

Item	Materials	Finish	Ral / Pantone	Led	Driver Included
0531 93	Shade: Methacrylate Ring: Steel	Matt white lacquer	RAL 9010	—	—
0532 01 /2B	Shade: Methacrylate Ring: Steel	Chrome	Metallic finish	3000 K. CRI >80. 8944 lm. 132,3 lm/W.	Constant Current 400 mA. 230V. 50Hz.
0532 01 /4B	Shade: Methacrylate Ring: Steel	Chrome	Metallic finish	4000 K. CRI >80. 9544 lm. 141,1 lm/W.	Constant Current 400 mA. 230V. 50Hz.
0532 93 /2B	Shade: Methacrylate Ring: Steel	Matt white lacquer	RAL 9010	3000 K. CRI >80. 8944 lm. 132,3 lm/W	Constant Current 400 mA. 230V. 50Hz.
0532 93 /4B	Shade: Methacrylate Ring: Steel	Matt white lacquer	RAL 9010	4000 K. CRI >80. 9544 lm. 141,1 lm/W	Constant Current 400 mA. 230V. 50Hz.
0533 01 /2B	Shade: Methacrylate Ring: Steel	Chrome	Metallic finish	3000 K. CRI >80. 8944 lm. 132,3 lm/W.	Constant Current 400 mA. 230V. 50Hz.
0533 01 /4B	Shade: Methacrylate Ring: Steel	Chrome	Metallic finish	4000 K. CRI >80. 9544 lm. 141,1 lm/W.	Constant Current 400 mA. 230V. 50Hz.
0533 93 /2B	Shade: Methacrylate Ring: Steel	Matt white lacquer	RAL 9010	3000 K. CRI >80. 8944 lm. 132,3 lm/W.	Constant Current 400 mA. 230V. 50Hz.
0533 93 /4B	Shade: Methacrylate Ring: Steel	Matt white lacquer	RAL 9010	4000 K. CRI >80. 9544 lm. 141,1 lm/W.	Constant Current 400 mA. 230V. 50Hz.
0535 01	Shade: Methacrylate Ring: Steel	Chrome	Metallic finish	—	—
0535 93	Shade: Methacrylate Ring: Steel	Matt white lacquer	RAL 9010	—	—
0536 01	Shade: Methacrylate Ring: Steel	Chrome	Metallic finish	—	—
0536 93	Shade: Methacrylate Ring: Steel	Matt white lacquer	RAL 9010	—	—
0537 01 /2B	Shade: Methacrylate Ring: Steel	Chrome	Metallic finish	3000 K. CRI >80. 8944 lm. 132,3 lm/W.	Constant Current 400 mA. 230V. 50Hz.
0537 01 /4B	Shade: Methacrylate Ring: Steel	Chrome	Metallic finish	4000 K. CRI >80. 9544 lm. 141,1 lm/W.	Constant Current 400 mA. 230V. 50Hz.
0537 93 /2B	Shade: Methacrylate Ring: Steel	Matt white lacquer	RAL 9010	3000 K. CRI >80. 8944 lm. 132,3 lm/W.	Constant Current 400 mA. 230V. 50Hz.
0537 93 /4B	Shade: Methacrylate Ring: Steel	Matt white lacquer	RAL 9010	4000 K. CRI >80. 9544 lm. 141,1 lm/W.	Constant Current 400 mA. 230V. 50Hz.
0538 01 /2B	Shade: Methacrylate Ring: Steel	Chrome	Metallic finish	3000 K. CRI >80. 8944 lm. 132,3 lm/W.	Constant Current 400 mA. 230V. 50Hz.
0538 01 /4B	Shade: Methacrylate Ring: Steel	Chrome	Metallic finish	4000 K. CRI >80. 9544 lm. 141,1 lm/W.	Constant Current 400 mA. 230V. 50Hz.
0538 93 /2B	Shade: Methacrylate Ring: Steel	Matt white lacquer	RAL 9010	3000 K. CRI >80. 8944 lm. 132,3 lm/W.	Constant Current 400 mA. 230V. 50Hz.
0538 93 /4B	Shade: Methacrylate Ring: Steel	Matt white lacquer	RAL 9010	4000 K. CRI >80. 9544 lm. 141,1 lm/W.	Constant Current 400 mA. 230V. 50Hz.
0540 01	Shade: Methacrylate Ring: Steel	Chrome	Metallic finish	—	—
0540 93	Shade: Methacrylate Ring: Steel	Matt white lacquer	RAL 9010	—	—
0543 01	Shade: Methacrylate Ring: Steel	Chrome	Metallic finish	—	—
0543 93	Shade: Methacrylate Ring: Steel	Matt white lacquer	RAL 9010	—	—
0544 01	Shade: Methacrylate Ring: Steel	Chrome	Metallic finish	—	—
0544 93	Shade: Methacrylate Ring: Steel	Matt white lacquer	RAL 9010	—	—

Item	Materials	Finish	Ral / Pantone	Led	Driver Included
0546 01	Shade: Methacrylate Ring: Steel	Chrome	Metallic finish	—	—
0546 93	Shade: Methacrylate Ring: Steel	Matt white lacquer	RAL 9010	—	—
0547 01	Shade: Methacrylate Ring: Steel	Chrome	Metallic finish	—	—
0547 93	Shade: Methacrylate Ring: Steel	Matt white lacquer	RAL 9010	—	—
Boxes					
4600 08	Head: Aluminum Box: Steel	Diffuser: Glass	Khaki lacquer	RAL 7006	—
4600 55	Head: Aluminum Box: Steel	Diffuser: Glass	Matt oxide lacquer	RAL 8017	—
Break					
4101 07 /10	Head: Polyurethane Base: Polyurethane	Diffuser: Methacrylate	Khaki lacquer	RAL 7006	2700 K. CRI >80. 580 lm. 93,5 lm/W.
4101 54 /10	Head: Polyurethane Base: Polyurethane	Diffuser: Methacrylate	Oxide-brown lacquer	RAL 8017	2700 K. CRI >80. 580 lm. 93,5 lm/W.
4101 80 /10	Head: Polyurethane Base: Polyurethane	Diffuser: Methacrylate	Concrete	natural finish	2700 K. CRI >80. 580 lm. 93,5 lm/W.
4106 07 /10	Head: Polyurethane Base: Polyurethane	Diffuser: Methacrylate	Khaki lacquer	RAL 7006	2700 K. CRI >80. 580 lm. 93,5 lm/W.
4106 54 /10	Head: Polyurethane Base: Polyurethane	Diffuser: Methacrylate	Oxide-brown lacquer	RAL 8017	2700 K. CRI >80. 580 lm. 93,5 lm/W.
4106 80 /10	Head: Polyurethane Base: Polyurethane	Diffuser: Methacrylate	Concrete	natural finish	2700 K. CRI >80. 580 lm. 93,5 lm/W.
4108 07 /10	Box: Steel	Diffuser: Methacrylate	Khaki lacquer	RAL 7006	2700K. CRI >80. 2532 lm. 109,1 lm/W.
4108 54 /10	Box: Steel	Diffuser: Methacrylate	Oxide lacquer	RAL 8017	2700K. CRI >80. 2532 lm. 109,1 lm/W.
4110 07 /10	Body: Aluminum	Diffuser: Methacrylate	Khaki lacquer	RAL 7006	2700 K. CRI >80. 199,3 lm. 94,9 lm/W.
4110 54 /10	Body: Aluminum	Diffuser: Methacrylate	Oxide-brown lacquer	RAL 8017	2700 K. CRI >80. 199,3 lm. 94,9 lm/W.
4110 80 /10	Body: Aluminum	Diffuser: Methacrylate	Concrete	natural finish	2700 K. CRI >80. 199,3 lm. 94,9 lm/W.
Brisa					
4625 07 /10	Shade and Base: Aluminum Vertical tube: Steel	Disc: Stainless steel	Khaki lacquer	RAL 7006	2700 K. CRI >80. 199,3 lm. 94,9 lm/W.
4625 54 /10	Shade and Base: Aluminum Vertical tube: Steel	Disc: Stainless steel	Matt oxide lacquer	RAL 8017	2700 K. CRI >80. 199,3 lm. 94,9 lm/W.
4630 07 /10	Shade and Base: Aluminum Vertical tube: Steel	Disc: Stainless steel	Khaki lacquer	RAL 7006	2700 K. CRI >80. 199,3 lm. 94,9 lm/W.
4630 54 /10	Shade and Base: Aluminum Vertical tube: Steel	Disc: Stainless steel	Matt oxide lacquer	RAL 8017	2700 K. CRI >80. 199,3 lm. 94,9 lm/W.
4635 07 /10	Shade and Base: Aluminum Vertical tube: Steel	Disc: Stainless steel	Khaki lacquer	RAL 7006	2700 K. CRI >80. 597,9 lm. 94,9 lm/W.
4635 54 /10	Shade and Base: Aluminum Vertical tube: Steel	Disc: Stainless steel	Matt oxide lacquer	RAL 8017	2700 K. CRI >80. 597,9 lm. 94,9 lm/W.
4640 07/10	Shade and Base: Aluminum Vertical tube: Steel	Disc: Stainless steel	Khaki lacquer	RAL 7006	2700 K. CRI >80. 996,5 lm. 94,9 lm/W.
4640 54 /10	Shade and Base: Aluminum Vertical tube: Steel	Disc: Stainless steel	Matt oxide lacquer	RAL 8017	2700 K. CRI >80. 996,5 lm. 94,9 lm/W.
Centric					
5700 58 /1B	Body: ABS Diffuser: Methacrylate	Ceiling rose: Steel	Matt cream lacquer	NCS S 2005-Y20R + NCS S 0502-Y	2700 K. CRI >80. 3372 lm. 145,3 lm/W.

	Item	Materials	Finish	Ral / Pantone	Led	Driver Included
	4205 07 /10	Body: Aluminum	Matt green lacquer	PANTONE 385	2700 K. CRI >80. 1594,3 lm. 94,9 lm/W.	Constant Current 700 mA. 100-240V. 50/60Hz.
	4205 14 /10	Body: Aluminum	Matt dark-brown lacquer	RAL 8019	2700 K. CRI >80. 1594,3 lm. 94,9 lm/W.	Constant Current 700 mA. 100-240V. 50/60Hz.
	4205 58 /10	Body: Aluminum	Off-white matt lacquer	RAL D2 1109005	2700 K. CRI >80. 1594,3 lm. 94,9 lm/W.	Constant Current 700 mA. 100-240V. 50/60Hz.
	4207 06 /10	Body: Aluminum	Matt red lacquer	PANTONE 704M	2700 K. CRI >80. 2790 lm. 94,8 lm/W.	Constant Current 700 mA. 100-240V. 50/60Hz.
	4207 07 /10	Body: Aluminum	Matt green lacquer	PANTONE 385	2700 K. CRI >80. 2790 lm. 94,8 lm/W.	Constant Current 700 mA. 100-240V. 50/60Hz.
	4207 14 /10	Body: Aluminum	Matt dark-brown lacquer	RAL 8019	2700 K. CRI >80. 2790 lm. 94,9 lm/W.	Constant Current 700 mA. 100-240V. 50/60Hz.
	4207 58 /10	Body: Aluminum	Off-white matt lacquer	RAL D2 1109005	2700 K. CRI >80. 2790 lm. 94,8 lm/W.	Constant Current 700 mA. 100-240V. 50/60Hz.
Fold Built-In	4210 03 /10	Plate: Plaster Diffuser: Methacrylate	Lid: Steel White	natural finish	2700 K. CRI >80. 398,6 lm. 94,9 lm/W.	Constant Current 700 mA. 100-240V. 50/60Hz.
	4211 03 /10	Plate: Plaster Diffuser: Methacrylate	Lid: Steel White	natural finish	2700 K. CRI >80. 1195,7 lm. 94,9 lm/W.	Constant Current 700 mA. 100-240V. 50/60Hz.
Funnel	2004 01	Body: Aluminum	Chrome	Metallic finish	—	—
	2004 03	Body: Aluminum	White lacquer	RAL 9003	—	—
	2004 04	Body: Aluminum	Black lacquer	RAL 9005	—	—
	2004 06	Body: Aluminum	Red lacquer	RAL 3002	—	—
	2005 03	Body: Aluminum	White lacquer	RAL 9003	—	—
	2007 03	Body: Aluminum	White lacquer	RAL 9003	—	—
	2012 51 /10	Body: Aluminum	Matt gold leaf	gold leaf	2700 K. CRI >80. 631,7 lm. 100,3 lm/W.	Constant Current 350 mA. 100-240V. 50/60Hz.
	2012 93 /10	Body: Aluminum	Matt white lacquer	RAL 9010	2700 K. CRI >80. 631,7 lm. 100,3 lm/W.	Constant Current 350 mA. 100-240V. 50/60Hz.
	2013 51 /1A	Body: Aluminum	Matt gold leaf	gold leaf	2700 K. CRI >80. 2941,6 lm. 108,9 lm/W.	Constant Current 350 mA. 110-240V. 50/60Hz.
	2013 93 /1A	Body: Aluminum	Matt white lacquer	RAL 9010	2700 K. CRI >80. 2941,6 lm. 108,9 lm/W.	Constant Current 350 mA. 110-240V. 50/60Hz.
	2014 93 /1A	Body: Aluminum	Matt white lacquer	RAL 9010	2700 K. CRI >80. 2941,6 lm. 108,9 lm/W.	Constant Current 350 mA. 110-240V. 50/60Hz.
Halley	4150 04	Diffuser: Polycarbonate	Arm: Steel Black	RAL 9005	3750 K. CRI >70. 1264,5 lm. 58,5 lm/W.	Constant Voltage 24V. 100-240V. 50/60Hz.
Halo	2330 03	Diffuser: PMMA.	Canopy: Steel Matt white lacquer	RAL 9016	3000 K. CRI >80. 2085,8 lm. 86,9 lm/W.	Constant Voltage 24V. 100-240V. 50/60Hz.
	2331 03	Diffuser: PMMA.	Canopy: Steel Matt white lacquer	RAL 9016	3000 K. CRI >80. 4171,7 lm. 86,9 lm/W.	Constant Voltage 24V. 100-240V. 50/60Hz.
	2332 03	Diffuser: PMMA.	Canopy: Steel Matt white lacquer	RAL 9016	3000 K. CRI >80. 6257,5 lm. 86,9 lm/W.	Constant Voltage 24V. 100-240V. 50/60Hz.
	2333 03	Diffuser: PMMA.	Canopy: Steel Matt white lacquer	RAL 9016	3000 K. CRI >80. 10429,2 lm. 86,9 lm/W.	Constant Voltage 24V. 100-240V. 50/60Hz.
	2340 03	Diffuser: PMMA.	Canopy: Steel Matt white lacquer	RAL 9016	3000 K. CRI >80. 2567,2 lm. 80,2 lm/W.	Constant Voltage 24V. 100-240V. 50/60Hz.

	Item	Materials	Finish	Ral / Pantone	Led	Driver Included
	2341 03	Diffuser: PMMA.	Canopy: Steel Matt white lacquer	RAL 9016	3000 K. CRI >80. 3850,8 lm. 80,2 lm/W.	Constant Voltage 24V. 100-240V. 50/60Hz.
	2342 03	Diffuser: PMMA.	Canopy: Steel Matt white lacquer	RAL 9016	3000 K. CRI >80. 7701,6 lm. 80,2 lm/W.	Constant Voltage 24V. 100-240V. 50/60Hz.
	2343 03	Diffuser: PMMA.	Canopy: Steel Matt white lacquer	RAL 9016	3000 K. CRI >80. 11552,4 lm. 80,2 lm/W.	Constant Voltage 24V. 100-240V. 50/60Hz.
I.Cono	0700 03	Shade: Polycarbonate Base: Zamak	Vertical tube: Steel Shiny white lacquer	RAL 9016	—	—
	0700 04	Shade: Polycarbonate Base: Zamak	Vertical tube: Steel Shiny black lacquer	RAL 9005	—	—
	0700 59	Shade: Polycarbonate Base: Zamak	Vertical tube: Steel Matt mink lacquer	PANTONE 406	—	—
	0700 93	Shade: Polycarbonate Base: Zamak	Vertical tube: Steel Matt white lacquer	RAL 9016	—	—
	0712 03	Shade: Polycarbonate Base: Zamak	Vertical tube: Steel Shiny white lacquer	RAL 9016	—	—
	0712 04	Shade: Polycarbonate Base: Zamak	Vertical tube: Steel Shiny black lacquer	RAL 9005	—	—
	0712 59	Shade: Polycarbonate Base: Zamak	Vertical tube: Steel Matt mink lacquer	PANTONE 406	—	—
	0712 93	Shade: Polycarbonate Base: Zamak	Vertical tube: Steel Matt white lacquer	RAL 9016	—	—
	0720 03	Shade: Polycarbonate	Base: Zamak Shiny white lacquer	RAL 9016	—	—
	0720 04	Shade: Polycarbonate	Base: Zamak Shiny black lacquer	RAL 9005	—	—
	0720 59	Shade: Polycarbonate	Base: Zamak Matt mink lacquer	PANTONE 406	—	—
	0720 93	Shade: Polycarbonate	Base: Zamak Matt white lacquer	RAL 9016	—	—
	0725 03	Shade: Polycarbonate Base: Zamak	Vertical tube: Steel Shiny white lacquer	RAL 9016	—	—
	0725 04	Shade: Polycarbonate Base: Zamak	Vertical tube: Steel Shiny black lacquer	RAL 9005	—	—
	0725 59	Shade: Polycarbonate Base: Zamak	Vertical tube: Steel Matt mink lacquer	PANTONE 406	—	—
	0725 93	Shade: Polycarbonate Base: Zamak	Vertical tube: Steel Matt white lacquer	RAL 9016	—	—
Jazz	1330 03	Body: Polyurethane	Diffuser: Glass White lacquer	RAL 9016	—	—
	1330 04	Body: Polyurethane	Diffuser: Glass Black lacquer	RAL 9005	—	—
	1330 06	Body: Polyurethane	Diffuser: Glass Red lacquer	RAL 3002	—	—
	1330 59	Body: Polyurethane	Diffuser: Glass Matt mink lacquer	PANTONE 406	—	—
	1330 93	Body: Polyurethane	Diffuser: Glass Matt white lacquer	RAL 9016	—	—
	1332 03	Body: Polyurethane Diffuser: Optical-glass	Shade: Aluminum White lacquer	RAL 9016	—	—
	1332 04	Body: Polyurethane Diffuser: Optical-glass	Shade: Aluminum Black lacquer	RAL 9005	—	—
	1332 06	Body: Polyurethane Diffuser: Optical-glass	Shade: Aluminum Red lacquer	RAL 3002	—	—

Product specifications subject to change without notice.
Please check vibia.com for updated information.

Item	Materials	Finish	Ral / Pantone	Led	Driver Included	
1332 59	Body: Polyurethane Diffuser: Optical-glass	Shade: Aluminum	Matt mink lacquer	PANTONE 406	—	—
1332 93	Body: Polyurethane Diffuser: Optical-glass	Shade: Aluminum	Matt white lacquer	RAL 9016	—	—
1333 03	Body: Polyurethane Diffuser: Optical-glass	Shade: Aluminum	White lacquer	RAL 9016	—	—
1333 04	Body: Polyurethane Diffuser: Optical-glass	Shade: Aluminum	Black lacquer	RAL 9005	—	—
1333 06	Body: Polyurethane Diffuser: Optical-glass	Shade: Aluminum	Red lacquer	RAL 3002	—	—
1333 59	Body: Polyurethane Diffuser: Optical-glass	Shade: Aluminum	Matt mink lacquer	PANTONE 406	—	—
1333 93	Body: Polyurethane Diffuser: Optical-glass	Shade: Aluminum	Matt white lacquer	RAL 9016	—	—
1336 03	Body: Polyurethane Diffuser: Glass	Canopy: Steel	White lacquer	RAL 9016	—	—
1336 04	Body: Polyurethane Diffuser: Glass	Canopy: Steel	Black lacquer	RAL 9005	—	—
1336 06	Body: Polyurethane Diffuser: Glass	Canopy: Steel	Red lacquer	RAL 3002	—	—
1336 59	Body: Polyurethane Diffuser: Glass	Canopy: Steel	Matt mink lacquer	PANTONE 406	—	—
1336 93	Body: Polyurethane Diffuser: Glass	Canopy: Steel	Matt white lacquer	RAL 9016	—	—
1338 03	Body: Polyurethane Diffuser: Glass	Canopy: Steel	White lacquer	RAL 9016	—	—
1338 04	Body: Polyurethane Diffuser: Glass	Canopy: Steel	Black lacquer	RAL 9005	—	—
1338 06	Body: Polyurethane Diffuser: Glass	Canopy: Steel	Red lacquer	RAL 3002	—	—
1338 59	Body: Polyurethane Diffuser: Glass	Canopy: Steel	Matt mink lacquer	PANTONE 406	—	—
1338 93	Body: Polyurethane Diffuser: Glass	Canopy: Steel	Matt white lacquer	RAL 9016	—	—
Join						
5066 01	Shade: Borosilicate glass	Borosilicate glass	—	—	—	—
5068 01	Shade: Blown-glass	Blown glass	—	—	—	—
June						
4730 54 / 10	Shade and diffuser: Polycarbonate + UV	Tubes: Steel	Matt dark-brown lacquer	PMS BLACK U	2760 K. CRI >80. 365,2 lm. 121,7 lm/W.	Constant Current 350 mA. 110-240V. 50/60Hz.
4735 54 / 10	Shade and diffuser: Polycarbonate + UV	Tubes: Steel	Matt dark-brown lacquer	PMS BLACK U	2760 K. CRI >80. 608,6 lm. 121,7 lm/W.	Constant Current 350 mA. 110-240V. 50/60Hz.
4745 54/10	Diffuser: Opal Blowed Glass	Tubes: Steel	Matt dark-brown lacquer	PMS BLACK U	2760 K. CRI >80. 365,2 lm. 121,7 lm/W.	Constant Current 350 mA. 110-240V. 50/60Hz.
4750 54 / 10	Diffuser: Opal Blowed Glass	Tubes: Steel	Matt dark-brown lacquer	PMS BLACK U	2760 K. CRI >80. 608,6 lm. 121,7 lm/W.	Constant Current 350 mA. 110-240V. 50/60Hz.
4765 54 / 10	Diffuser: Opal Blowed Glass	Tubes: Steel	Matt dark-brown lacquer	PMS BLACK U	2760 K. CRI >80. 121,7 lm. 121,7 lm/W.	Constant Current 350 mA. 110-240V. 50/60Hz.
4770 54 / 10	Diffuser: Opal Blowed Glass	Tubes: Steel	Matt dark-brown lacquer	PMS BLACK U	2760 K. CRI >80. 121,7 lm. 121,7 lm/W.	Constant Current 350 mA. 110-240V. 50/60Hz.
4775 54 / 10	Diffuser: Opal Blowed Glass	Tubes: Steel	Matt dark-brown lacquer	PMS BLACK U	2760 K. CRI >80. 243,4 lm. 121,7 lm/W.	Constant Current 350 mA. 110-240V. 50/60Hz.

Item	Materials	Finish	Ral / Pantone	Led	Driver Included
4780 54 / 10	Diffuser: Opal Blowed Glass Tubes: Steel	Matt dark-brown lacquer	PMS BLACK U	2760 K. CRI >80. 121,7 lm. 121,7 lm/W.	Constant Current 350 mA. 110-240V. 50/60Hz.
4785 54 / 10	Diffuser: Opal Blowed Glass Tubes: Steel	Matt dark-brown lacquer	PMS BLACK U	2760 K. CRI >80. 243,4 lm. 121,7 lm/W.	Constant Current 350 mA. 110-240V. 50/60Hz.
4790 54 / 15	Diffuser: Opal Blowed Glass Body: Aluminum	Matt dark-brown lacquer	PMS BLACK U	2760 K. CRI >80. 121,7 lm. 121,7 lm/W.	Constant Current 350 mA. 110-240V. 50/60Hz.
4795 54 / 15	Diffuser: Opal Blowed Glass Body: Aluminum	Matt dark-brown lacquer	PMS BLACK U	2760 K. CRI >80. 365,2 lm. 121,7 lm/W.	Constant Current 350 mA. 110-240V. 50/60Hz.
Link					
5373 03	Box: Polyurethane Diffuser: Methacrylate	Shiny white lacquer	RAL 9010	—	—
5373 18	Box: Polyurethane Diffuser: Methacrylate	Shiny graphite lacquer	RAL 7016	—	—
5376 03	Box: Polyurethane Diffuser: Methacrylate	Shiny white lacquer	RAL 9010	—	—
5376 18	Box: Polyurethane Diffuser: Methacrylate	Shiny graphite lacquer	RAL 7016	—	—
5379 03	Box: Polyurethane Diffuser: Methacrylate	Shiny white lacquer	RAL 9010	—	—
5379 18	Box: Polyurethane Diffuser: Methacrylate	Shiny graphite lacquer	RAL 7016	—	—
5380 03	Box: Polyurethane Diffuser: Methacrylate	Shiny white lacquer	RAL 9010	—	—
5380 18	Box: Polyurethane Diffuser: Methacrylate	Shiny graphite lacquer	RAL 7016	—	—
5381 03	Box: Polyurethane Diffuser: Methacrylate	Shiny white lacquer	RAL 9010	—	—
5381 18	Box: Polyurethane Diffuser: Methacrylate	Shiny graphite lacquer	RAL 7016	—	—
5384 03	Box: Polyurethane Diffuser: Methacrylate	Shiny white lacquer	RAL 9010	—	—
5384 18	Box: Polyurethane Diffuser: Methacrylate	Shiny graphite lacquer	RAL 7016	—	—
5385 03	Box: Polyurethane Diffuser: Methacrylate	Shiny white lacquer	RAL 9010	—	—
5385 18	Box: Polyurethane Diffuser: Methacrylate	Shiny graphite lacquer	RAL 7016	—	—
5388 03	Box: Polyurethane Diffuser: Methacrylate	Shiny white lacquer	RAL 9010	—	—
5388 18	Box: Polyurethane Diffuser: Methacrylate	Shiny graphite lacquer	RAL 7016	—	—
5389 03	Box: Polyurethane Diffuser: Methacrylate	Shiny white lacquer	RAL 9010	—	—
5389 18	Box: Polyurethane Diffuser: Methacrylate	Shiny graphite lacquer	RAL 7016	—	—
5395 03	Box: Polyurethane Diffuser: Methacrylate	Shiny white lacquer	RAL 9010	—	—
5395 18	Box: Polyurethane Diffuser: Methacrylate	Shiny graphite lacquer	RAL 7016	—	—
5396 03	Box: Polyurethane Diffuser: Methacrylate	Shiny white lacquer	RAL 9010	—	—
5396 18	Box: Polyurethane Diffuser: Methacrylate	Shiny graphite lacquer	RAL 7016	—	—
Link XXL					
5351 03	Body: Polyurethane foam Diffuser: Polycarbonate	Matt white lacquer	RAL 9010	4000 K. CRI >80. 2532 lm. 109,1 lm/W.	Constant Current 350 mA. 110-240V. 50/60Hz.
5351 18	Body: Polyurethane foam Diffuser: Polycarbonate	Graphite grey	RAL 7016	4000 K. CRI >80. 2532 lm. 109,1 lm/W.	Constant Current 350 mA. 110-240V. 50/60Hz.
5356 03	Body: Polyurethane foam Diffuser: Polycarbonate	Matt white lacquer	RAL 9010	4000 K. CRI >80. 2532 lm. 109,1 lm/W.	Constant Current 350 mA. 110-240V. 50/60Hz.
5356 18	Body: Polyurethane foam Diffuser: Polycarbonate	Graphite grey	RAL 7016	4000 K. CRI >80. 2532 lm. 109,1 lm/W.	Constant Current 350 mA. 110-240V. 50/60Hz.
5361 03	Body: Polyurethane foam Diffuser: Polycarbonate	Matt white lacquer	RAL 9010	4000 K. CRI >80. 2532 lm. 109,1 lm/W.	Constant Current 350 mA. 110-240V. 50/60Hz.

	Item	Materials	Finish	Ral / Pantone	Led	Driver Included
	5361 18	Body: Polyurethane foam Diffuser: Polycarbonate	Graphite grey	RAL 7016	4000 K. CRI >80. 2532 lm. 109,1 lm/W.	Constant Current 350 mA. 110-240V. 50/60Hz.
	5366 03	Body: Polyurethane foam Diffuser: Polycarbonate	Matt white lacquer	RAL 9010	4000 K. CRI >80. 2532 lm. 109,1 lm/W.	Constant Current 350 mA. 110-240V. 50/60Hz.
	5366 18	Body: Polyurethane foam Diffuser: Polycarbonate	Graphite grey	RAL 7016	4000 K. CRI >80. 2532 lm. 109,1 lm/W.	Constant Current 350 mA. 110-240V. 50/60Hz.
Match	/1A	Head: Aluminum Rods: Steel	Canopy Plate: Steel Matt white lacquer / Matt graphite lacquer	RAL 9016/RAL7016	2700 K. CRI >80. 199,2 lm. 94,9 lm/W.	Constant Current 700 mA. 110-240V. 50/60Hz.
Mayfair	5500 07 /16	Shade: Methacrylate Diffuser: Polycarbonate	Rod: Steel Base: Zamak Gloss black nickel and green	Metallic finish	2700 K. CRI >80. 1840,5 lm. 95,8 lm/W.	Constant Voltage 24V. 100-240V. 50/60Hz.
	5500 08 /16	Shade: Methacrylate Diffuser: Polycarbonate	Rod: Steel Base: Zamak Gloss black nickel and orange	Metallic finish	2700 K. CRI >80. 1840,5 lm. 95,8 lm/W.	Constant Voltage 24V. 100-240V. 50/60Hz.
	5505 18 /16	Shade: Steel Diffuser: Polycarbonate	Rod: Steel Base: Zamak Matt graphite lacquer	RAL 7016	2700 K. CRI >80. 1840,5 lm. 95,8 lm/W.	Constant Voltage 24V. 100-240V. 50/60Hz.
	5505 20 /16	Shade: Steel Diffuser: Polycarbonate	Rod: Steel Base: Zamak Matt gold	Metallic finish	2700 K. CRI >80. 1840,5 lm. 95,8 lm/W.	Constant Voltage 24V. 100-240V. 50/60Hz.
	5505 67 /16	Shade: Steel Diffuser: Polycarbonate	Rod: Steel Base: Zamak Gloss Copper	Metallic finish	2700 K. CRI >80. 1840,5 lm. 95,8 lm/W.	Constant Voltage 24V. 100-240V. 50/60Hz.
	5505 93 /16	Shade: Steel Diffuser: Polycarbonate	Rod: Steel Base: Zamak Matt white lacquer	RAL 9016	2700 K. CRI >80. 1840,5 lm. 95,8 lm/W.	Constant Voltage 24V. 100-240V. 50/60Hz.
	5510 07 /16	Shade: Methacrylate Diffuser: Polycarbonate	Rod: Steel Base: Zamak Gloss black nickel and green	Metallic finish	2700 K. CRI >80. 1840,5 lm. 95,8 lm/W.	Constant Voltage 24V. 100-240V. 50/60Hz.
	5510 08 /16	Shade: Methacrylate Diffuser: Polycarbonate	Rod: Steel Base: Zamak Gloss black nickel and orange	Metallic finish	2700 K. CRI >80. 1840,5 lm. 95,8 lm/W.	Constant Voltage 24V. 100-240V. 50/60Hz.
	5515 18 /16	Shade: Steel Diffuser: Polycarbonate	Rod: Steel Base: Zamak Matt graphite lacquer	RAL 7016	2700 K. CRI >80. 1840,5 lm. 95,8 lm/W.	Constant Voltage 24V. 100-240V. 50/60Hz.
	5515 20 /16	Shade: Steel Diffuser: Polycarbonate	Rod: Steel Base: Zamak Matt gold	Metallic finish	2700 K. CRI >80. 1840,5 lm. 95,8 lm/W.	Constant Voltage 24V. 100-240V. 50/60Hz.
	5515 67 /16	Shade: Steel Diffuser: Polycarbonate	Rod: Steel Base: Zamak Gloss Copper	Metallic finish	2700 K. CRI >80. 1840,5 lm. 95,8 lm/W.	Constant Voltage 24V. 100-240V. 50/60Hz.
	5515 93 /16	Shade: Steel Diffuser: Polycarbonate	Rod: Steel Base: Zamak Matt white lacquer	RAL 9016	2700 K. CRI >80. 1840,5 lm. 95,8 lm/W.	Constant Voltage 24V. 100-240V. 50/60Hz.
	5520 07 /1B	Shade: Methacrylate Diffuser: Polycarbonate	Rod: Steel Ceiling rose: Steel Gloss black nickel and green	Metallic finish	2700 K. CRI >80. 1840,5 lm. 95,8 lm/W.	Constant Voltage 24V. 110-240V. 50/60Hz.
	5520 08 /1B	Shade: Methacrylate Diffuser: Polycarbonate	Rod: Steel Ceiling rose: Steel Gloss black nickel and orange	Metallic finish	2700 K. CRI >80. 1840,5 lm. 95,8 lm/W.	Constant Voltage 24V. 110-240V. 50/60Hz.
	5525 18 /1B	Shade: Steel Diffuser: Polycarbonate	Rod: Steel Ceiling rose: Steel Matt graphite lacquer	RAL 7016	2700 K. CRI >80. 1840,5 lm. 95,8 lm/W.	Constant Voltage 24V. 110-240V. 50/60Hz.
	5525 20 /1B	Shade: Steel Diffuser: Polycarbonate	Rod: Steel Ceiling rose: Steel Matt gold	Metallic finish	2700 K. CRI >80. 1840,5 lm. 95,8 lm/W.	Constant Voltage 24V. 110-240V. 50/60Hz.
	5525 67 /1B	Shade: Steel Diffuser: Polycarbonate	Rod: Steel Ceiling rose: Steel Gloss Copper	Metallic finish	2700 K. CRI >80. 1840,5 lm. 95,8 lm/W.	Constant Voltage 24V. 110-240V. 50/60Hz.
	5525 93 /1B	Shade: Steel Diffuser: Polycarbonate	Rod: Steel Ceiling rose: Steel Matt white lacquer	RAL 9016	2700 K. CRI >80. 1840,5 lm. 95,8 lm/W.	Constant Voltage 24V. 110-240V. 50/60Hz.
	5530 07 /13	Shade: Methacrylate Diffuser: Polycarbonate	Rod: Steel Ceiling rose: Steel Gloss black nickel and green	Metallic finish	2700 K. CRI >80. 5521,5 lm. 95,8 lm/W.	Constant Voltage 24V. 110-240V. 50/60Hz.
	5530 08 /13	Shade: Methacrylate Diffuser: Polycarbonate	Rod: Steel Ceiling rose: Steel Gloss black nickel and orange	Metallic finish	2700 K. CRI >80. 5521,5 lm. 95,8 lm/W.	Constant Voltage 24V. 110-240V. 50/60Hz.
	5535 18 /13	Shade: Steel Diffuser: Polycarbonate	Rod: Steel Ceiling rose: Steel Matt graphite lacquer	RAL 7016	2700 K. CRI >80. 5521,5 lm. 95,8 lm/W.	Constant Voltage 24V. 110-240V. 50/60Hz.
	5535 20 /13	Shade: Steel Diffuser: Polycarbonate	Rod: Steel Ceiling rose: Steel Matt gold	Metallic finish	2700 K. CRI >80. 5521,5 lm. 95,8 lm/W.	Constant Voltage 24V. 110-240V. 50/60Hz.

	Item	Materials	Finish	Ral / Pantone	Led	Driver Included
	5535 67 /13	Shade: Steel Diffuser: Polycarbonate	Rod: Steel Ceiling rose: Steel Gloss Copper	Metallic finish	2700 K. CRI >80. 5521,5 lm. 95,8 lm/W.	Constant Voltage 24V. 110-240V. 50/60Hz.
	5535 93 /13	Shade: Steel Diffuser: Polycarbonate	Rod: Steel Ceiling rose: Steel Matt white lacquer	RAL 9016	2700 K. CRI >80. 5521,5 lm. 95,8 lm/W.	Constant Voltage 24V. 110-240V. 50/60Hz.
Meridiano	4710 07/10	Seat: Polyurethane foam Rods: Steel	Arm: Steel Diffuser: Glass Khaki lacquer	RAL 7006	2700 K. CRI >80. 578,1 lm. 75 lm/W.	Constant Current 700 mA. 100-240V. 50/60Hz.
	4710 58 /10	Seat: Polyurethane foam Rods: Steel	Arm: Steel Diffuser: Glass Off-white matt lacquer	PANTONE WARM GRAY 2U	2700 K. CRI >80. 578,1 lm. 75 lm/W.	Constant Current 700 mA. 100-240V. 50/60Hz.
	4710 62 /10	Seat: Polyurethane foam Rods: Steel	Arm: Steel Diffuser: Glass Matt green lacquer	RAL 6021	2700 K. CRI >80. 578,1 lm. 75 lm/W.	Constant Current 700 mA. 100-240V. 50/60Hz.
	4715 07 /10	Seat: Polyurethane foam Rods: Steel	Arm: Steel Diffuser: Glass Khaki lacquer	RAL 7006	2700 K. CRI >80. 578,1 lm. 75 lm/W.	Constant Current 700 mA. 100-240V. 50/60Hz.
	4715 58 /10	Seat: Polyurethane foam Rods: Steel	Arm: Steel Diffuser: Glass Off-white matt lacquer	PANTONE WARM GRAY 2U	2700 K. CRI >80. 578,1 lm. 75 lm/W.	Constant Current 700 mA. 100-240V. 50/60Hz.
	4715 62 /10	Seat: Polyurethane foam Rods: Steel	Arm: Steel Diffuser: Glass Matt green lacquer	RAL 6021	2700 K. CRI >80. 578,1 lm. 75 lm/W.	Constant Current 700 mA. 100-240V. 50/60Hz.
	4717 07	Seat: Polyurethane foam Rods: Steel	Arm: Steel Diffuser: Glass Khaki lacquer	RAL 7006	—	—
	4717 58	Seat: Polyurethane foam Rods: Steel	Arm: Steel Diffuser: Glass Off-white matt lacquer	PANTONE WARM GRAY 2U	—	—
	4717 62	Seat: Polyurethane foam Rods: Steel	Arm: Steel Diffuser: Glass Matt green lacquer	RAL 6021	—	—
	4720 07 /10	Base: Steel	Khaki lacquer	RAL 7006	2700 K. CRI >80. 578,1 lm. 75 lm/W.	Constant Current 700 mA. 100-240V. 50/60Hz.
	4720 58 /10	Base: Steel	Off-white matt lacquer	PANTONE WARM GRAY 2U	2700 K. CRI >80. 578,1 lm. 75 lm/W.	Constant Current 700 mA. 100-240V. 50/60Hz.
	4720 62 /10	Base: Steel	Matt green lacquer	RAL 6021	2700 K. CRI >80. 578,1 lm. 75 lm/W.	Constant Current 700 mA. 100-240V. 50/60Hz.
Micro	2015 03 /10	Diffuser: Polycarbonate	White lacquer	RAL 9016	2700 K. CRI >80. 365,2 lm. 121,7 lm/W.	Constant Current 350 mA. 100-240V. 50/60Hz.
	2015 54 /10	Diffuser: Polycarbonate	Oxide-brown lacquer	RAL 8017	2700 K. CRI >80. 365,2 lm. 121,7 lm/W.	Constant Current 350 mA. 100-240V. 50/60Hz.
Millenium	8090 01	Diffuser: Polycarbonate	Body: Aluminum Chrome	Metallic finish	—	—
	8091 01	Diffuser: Polycarbonate	Body: Aluminum Chrome	Metallic finish	—	—
	8092 01	Diffuser: Polycarbonate	Body: Aluminum Chrome	Metallic finish	—	—
	8093 01	Diffuser: Polycarbonate	Body: Aluminum Chrome	Metallic finish	—	—
	8094 01	Diffuser: Polycarbonate	Body: Aluminum Chrome	Metallic finish	—	—
	8095 01	Diffuser: Polycarbonate	Body: Aluminum Chrome	Metallic finish	—	—
North	5600 04 /15	Rods: Carbon Fiber Shade: Aluminum	Base: Steel Matt graphite lacquer	NCS S8500-N	2700 K. CRI >80. 2082,1 lm. 116 lm/W.	Constant Current 350mA. 110-240V. 50/60Hz.
	5600 05 /15	Rods: Carbon Fiber Shade: Aluminum	Base: Steel Matt blue lacquer	NCS 3040-B10G	2700 K. CRI >80. 2082,1 lm. 116 lm/W.	Constant Current 350mA. 110-240V. 50/60Hz.
	5600 58 /15	Rods: Carbon Fiber Shade: Aluminum	Base: Steel Matt cream lacquer	NCS S 2005-Y20R	2700 K. CRI >80. 2082,1 lm. 116 lm/W.	Constant Current 350mA. 110-240V. 50/60Hz.
	5600 93 /15	Rods: Carbon Fiber Shade: Aluminum	Base: Steel Matt white lacquer	NCS S 0502-Y	2700 K. CRI >80. 2082,1 lm. 116 lm/W.	Constant Current 350mA. 110-240V. 50/60Hz.
	5605 04 /15	Rods: Carbon Fiber Shade: Aluminum	Base: Steel Matt graphite lacquer	NCS S8500-N	2700 K. CRI >80. 2082,1 lm. 116 lm/W.	Constant Current 350mA. 110-240V. 50/60Hz.
	5605 05 /15	Rods: Carbon Fiber Shade: Aluminum	Base: Steel Matt blue lacquer	NCS 3040-B10G	2700 K. CRI >80. 2082,1 lm. 116 lm/W.	Constant Current 350mA. 110-240V. 50/60Hz.

Product specifications subject to change without notice.
Please check vibia.com for updated information.

	Item	Materials	Finish	Ral / Pantone	Led	Driver Included
	5442 03 /10	Diffuser: Blown-glass	White	RAL 9016	2700 K. CRI >80. 3286 lm. 111,7 lm/W.	Constant Current 350 mA. 100-240V. 50/60Hz.
	5445 03	Diffuser: Blown-glass	White	RAL 9016	—	—
	5447 03 /10	Diffuser: Blown-glass	White	RAL 9016	2700 K. CRI >80. 5750,5 lm. 111,7 lm/W.	Constant Current 350 mA. 100-240V. 50/60Hz.
Puck Wall Art	5460 03	Shade: ABS Diffuser: Methacrylate	Matt white lacquer	RAL 9010	—	—
	5460 08	Shade: ABS Diffuser: Methacrylate	Matt orange lacquer	PANTONE 1495M	—	—
	5460 14	Shade: ABS Diffuser: Methacrylate	Matt dark-brown lacquer	RAL 8019	—	—
	5461 03	Shade: ABS Diffuser: Methacrylate	Matt white lacquer	RAL 9010	—	—
	5461 08	Shade: ABS Diffuser: Methacrylate	Matt orange lacquer	PANTONE 1495M	—	—
	5461 14	Shade: ABS Diffuser: Methacrylate	Matt dark-brown lacquer	RAL 8019	—	—
	5464 03	Shade: ABS Diffuser: Methacrylate	Matt white lacquer	RAL 9010	—	—
	5464 08	Shade: ABS Diffuser: Methacrylate	Matt orange lacquer	PANTONE 1495M	—	—
	5464 14	Shade: ABS Diffuser: Methacrylate	Matt dark-brown lacquer	RAL 8019	—	—
	5466 03	Shade: ABS Diffuser: Methacrylate	Matt white lacquer	RAL 9010	—	—
	5466 08	Shade: ABS Diffuser: Methacrylate	Matt orange lacquer	PANTONE 1495M	—	—
	5466 14	Shade: ABS Diffuser: Methacrylate	Matt dark-brown lacquer	RAL 8019	—	—
	5468 03	Shade: ABS Diffuser: Methacrylate	Matt white lacquer	RAL 9010	—	—
	5468 08	Shade: ABS Diffuser: Methacrylate	Matt orange lacquer	PANTONE 1495M	—	—
	5468 14	Shade: ABS Diffuser: Methacrylate	Matt dark-brown lacquer	RAL 8019	—	—
	Quadra Ice	1128 00	Diffuser: Glass	White glass	RAL 9016	—
1129 00		Diffuser: Glass	White glass	RAL 9016	—	—
1132 00		Diffuser: Glass	White glass	RAL 9016	—	—
1133 00		Diffuser: Glass	White glass	RAL 9016	—	—
1134 00		Diffuser: Glass	White glass	RAL 9016	—	—
1138 00 /1B		Diffuser: Glass	White glass	RAL 9016	2700 K. CRI >80. 1637 lm. 99,2 lm/W.	Constant Current 500 mA. 110-240V. 50/60Hz.
1139 00 /1B		Diffuser: Glass	White glass	RAL 9016	2700 K. CRI >80. 2203 lm. 95,3 lm/W.	Constant Current 700 mA. 110-240V. 50/60Hz.
Rhythm		2110 14 /13	Stick: PA6 + GF 10% Diffuser: Polycarbonate	Matt dark-brown lacquer	RAL 8019	2700 K. CRI >80. 3460 lm. 119,3 lm/W.
	2110 58 /13	Stick: PA6 + GF 10% Diffuser: Polycarbonate	Off-white matt lacquer	RAL D2 1109005	2700 K. CRI >80. 3460 lm. 119,3 lm/W.	Constant Voltage 30V. 100-240V. 50/60Hz.
	2111 14 /13	Stick: PA6 + GF 10% Diffuser: Polycarbonate	Matt dark-brown lacquer	RAL 8019	2700 K. CRI >80. 6920 lm. 119,3 lm/W.	Constant Voltage 30V. 100-240V. 50/60Hz.

	Item	Materials	Finish	Ral / Pantone	Led	Driver Included
	2111 58 /13	Stick: PA6 + GF 10% Diffuser: Polycarbonate	Off-white matt lacquer	RAL D2 1109005	2700 K. CRI >80. 6920 lm. 119,3 lm/W.	Constant Voltage 30V. 100-240V. 50/60Hz.
	2112 14 /13	Stick: PA6 + GF 10% Diffuser: Polycarbonate	Matt dark-brown lacquer	RAL 8019	2700 K. CRI >80. 10380 lm. 119,3 lm/W.	Constant Voltage 30V. 100-240V. 50/60Hz.
	2112 58 /13	Stick: PA6 + GF 10% Diffuser: Polycarbonate	Off-white matt lacquer	RAL D2 1109005	2700 K. CRI >80. 10380 lm. 119,3 lm/W.	Constant Voltage 30V. 100-240V. 50/60Hz.
	2113 14 /13	Stick: PA6 + GF 10% Diffuser: Polycarbonate	Matt dark-brown lacquer	RAL 8019	2700 K. CRI >80. 13840 lm. 119,3 lm/W.	Constant Voltage 30V. 100-240V. 50/60Hz.
	2113 58 /13	Stick: PA6 + GF 10% Diffuser: Polycarbonate	Off-white matt lacquer	RAL D2 1109005	2700 K. CRI >80. 13840 lm. 119,3 lm/W.	Constant Voltage 30V. 100-240V. 50/60Hz.
	2120 14 /13	Stick: PA6 + GF 10% Diffuser: Polycarbonate	Matt dark-brown lacquer	RAL 8019	2700 K. CRI >80. 6920 lm. 119,3 lm/W.	Constant Voltage 30V. 100-240V. 50/60Hz.
	2120 58 /13	Stick: PA6 + GF 10% Diffuser: Polycarbonate	Off-white matt lacquer	RAL D2 1109005	2700 K. CRI >80. 6920 lm. 119,3 lm/W.	Constant Voltage 30V. 100-240V. 50/60Hz.
	2121 14 /13	Stick: PA6 + GF 10% Diffuser: Polycarbonate	Matt dark-brown lacquer	RAL 8019	2700 K. CRI >80. 13840 lm. 119,3 lm/W.	Constant Voltage 30V. 100-240V. 50/60Hz.
	2121 58 /13	Stick: PA6 + GF 10% Diffuser: Polycarbonate	Off-white matt lacquer	RAL D2 1109005	2700 K. CRI >80. 13840 lm. 119,3 lm/W.	Constant Voltage 30V. 100-240V. 50/60Hz.
	2122 14 /13	Stick: PA6 + GF 10% Diffuser: Polycarbonate	Matt dark-brown lacquer	RAL 8019	2700 K. CRI >80. 20760 lm. 119,3 lm/W.	Constant Voltage 30V. 100-240V. 50/60Hz.
	2122 58 /13	Stick: PA6 + GF 10% Diffuser: Polycarbonate	Off-white matt lacquer	RAL D2 1109005	2700 K. CRI >80. 20760 lm. 119,3 lm/W.	Constant Voltage 30V. 100-240V. 50/60Hz.
	2130 14 /13	Stick: PA6 + GF 10% Diffuser: Polycarbonate	Matt dark-brown lacquer	RAL 8019	2700 K. CRI >80. 5190 lm. 119,3 lm/W.	Constant Voltage 30V. 100-240V. 50/60Hz.
	2130 58 /13	Stick: PA6 + GF 10% Diffuser: Polycarbonate	Off-white matt lacquer	RAL D2 1109005	2700 K. CRI >80. 5190 lm. 119,3 lm/W.	Constant Voltage 30V. 100-240V. 50/60Hz.
	2131 14 /13	Stick: PA6 + GF 10% Diffuser: Polycarbonate	Matt dark-brown lacquer	RAL 8019	2700 K. CRI >80. 10380 lm. 119,3 lm/W.	Constant Voltage 30V. 100-240V. 50/60Hz.
	2131 58 /13	Stick: PA6 + GF 10% Diffuser: Polycarbonate	Off-white matt lacquer	RAL D2 1109005	2700 K. CRI >80. 10380 lm. 119,3 lm/W.	Constant Voltage 30V. 100-240V. 50/60Hz.
	2132 14 /13	Stick: PA6 + GF 10% Diffuser: Polycarbonate	Matt dark-brown lacquer	RAL 8019	2700 K. CRI >80. 15570 lm. 119,3 lm/W.	Constant Voltage 30V. 100-240V. 50/60Hz.
	2132 58 /13	Stick: PA6 + GF 10% Diffuser: Polycarbonate	Off-white matt lacquer	RAL D2 1109005	2700 K. CRI >80. 15570 lm. 119,3 lm/W.	Constant Voltage 30V. 100-240V. 50/60Hz.
	2133 14 /13	Stick: PA6 + GF 10% Diffuser: Polycarbonate	Matt dark-brown lacquer	RAL 8019	2700 K. CRI >80. 20760 lm. 119,3 lm/W.	Constant Voltage 30V. 100-240V. 50/60Hz.
	2133 58 /13	Stick: PA6 + GF 10% Diffuser: Polycarbonate	Off-white matt lacquer	RAL D2 1109005	2700 K. CRI >80. 20760 lm. 119,3 lm/W.	Constant Voltage 30V. 100-240V. 50/60Hz.
	2140 14 /13	Stick: PA6 + GF 10% Diffuser: Polycarbonate	Matt dark-brown lacquer	RAL 8019	2700 K. CRI >80. 3460 lm. 119,3 lm/W.	Constant Voltage 30V. 100-240V. 50/60Hz.
	2140 58 /13	Stick: PA6 + GF 10% Diffuser: Polycarbonate	Off-white matt lacquer	RAL D2 1109005	2700 K. CRI >80. 3460 lm. 119,3 lm/W.	Constant Voltage 30V. 100-240V. 50/60Hz.
	2141 14 /13	Stick: PA6 + GF 10% Diffuser: Polycarbonate	Matt dark-brown lacquer	RAL 8019	2700 K. CRI >80. 6920 lm. 119,3 lm/W.	Constant Voltage 30V. 100-240V. 50/60Hz.
	2141 58 /13	Stick: PA6 + GF 10% Diffuser: Polycarbonate	Off-white matt lacquer	RAL D2 1109005	2700 K. CRI >80. 6920 lm. 119,3 lm/W.	Constant Voltage 30V. 100-240V. 50/60Hz.
	2142 14 /13	Stick: PA6 + GF 10% Diffuser: Polycarbonate	Matt dark-brown lacquer	RAL 8019	2700 K. CRI >80. 10380 lm. 119,3 lm/W.	Constant Voltage 30V. 100-240V. 50/60Hz.
	2142 58 /13	Stick: PA6 + GF 10% Diffuser: Polycarbonate	Off-white matt lacquer	RAL D2 1109005	2700 K. CRI >80. 10380 lm. 119,3 lm/W.	Constant Voltage 30V. 100-240V. 50/60Hz.
	2143 14 /13	Stick: PA6 + GF 10% Diffuser: Polycarbonate	Matt dark-brown lacquer	RAL 8019	2700 K. CRI >80. 13840 lm. 119,3 lm/W.	Constant Voltage 30V. 100-240V. 50/60Hz.

	Item	Materials	Finish	Ral / Pantone	Led	Driver Included
	0509 01	Shade: Screen Horizontal tube: Steel	Chrome	Metallic finish	—	—
	0509 18	Shade: Screen Horizontal tube: Steel	Matt graphite lacquer	RAL 7016	—	—
	0509 93	Shade: Screen Horizontal tube: Steel	Matt white lacquer	RAL 9016	—	—
	0514 01 /10	Shade: Screen Horizontal tube: Steel	Chrome	Metallic finish	2700K. CRI >80. 1005,3 lm. 90,6 lm/W.	Constant Current 700 mA. 100-240V. 50/60Hz.
	0514 18 /10	Shade: Screen Horizontal tube: Steel	Matt graphite lacquer	RAL 7016	2700K. CRI >80. 1005,3 lm. 90,6 lm/W.	Constant Current 700 mA. 100-240V. 50/60Hz.
	0514 93 /10	Shade: Screen Horizontal tube: Steel	Matt white lacquer	RAL 9016	2700K. CRI >80. 1005,3 lm. 90,6 lm/W.	Constant Current 700 mA. 100-240V. 50/60Hz.
	0516 01 /10	Body: Aluminum Horizontal tube: Steel	Chrome	Metallic finish	2700K. CRI >80. 490,3 lm. 109 lm/W.	Constant Current 350 mA. 100-240V. 50/60Hz.
	0516 18 /10	Body: Aluminum Horizontal tube: Steel	Matt graphite lacquer	RAL 7016	2700K. CRI >80. 490,3 lm. 109 lm/W.	Constant Current 350 mA. 100-240V. 50/60Hz.
	0516 93 /10	Body: Aluminum Horizontal tube: Steel	Matt white lacquer	RAL 9016	2700K. CRI >80. 490,3 lm. 109 lm/W.	Constant Current 350 mA. 100-240V. 50/60Hz.
	0521 01 /10	Body: Aluminum Horizontal tube: Steel	Chrome	Metallic finish	2700K. CRI >80. 490,3 lm. 109 lm/W.	Constant Current 350 mA. 100-240V. 50/60Hz.
	0521 18 /10	Body: Aluminum Horizontal tube: Steel	Matt graphite lacquer	RAL 7016	2700K. CRI >80. 490,3 lm. 109 lm/W.	Constant Current 350 mA. 100-240V. 50/60Hz.
	0521 93 /10	Body: Aluminum Horizontal tube: Steel	Matt white lacquer	RAL 9016	2700K. CRI >80. 490,3 lm. 109 lm/W.	Constant Current 350 mA. 100-240V. 50/60Hz.
	0526 01 /10	Body: Aluminum Vertical tube: Steel	Chrome	Metallic finish	2700K. CRI >80. 490,3 lm. 109 lm/W.	Constant Current 350 mA. 100-240V. 50/60Hz.
	0526 18 /10	Body: Aluminum Vertical tube: Steel	Matt graphite lacquer	RAL 7016	2700K. CRI >80. 490,3 lm. 109 lm/W.	Constant Current 350 mA. 100-240V. 50/60Hz.
	0526 93 /10	Body: Aluminum Vertical tube: Steel	Matt white lacquer	RAL 9016	2700K. CRI >80. 490,3 lm. 109 lm/W.	Constant Current 350 mA. 100-240V. 50/60Hz.
Tree	4000 03	Diffuser: Polyethylene Vertical tube: Steel	White lacquer	RAL 9016	—	—
	4000 14	Diffuser: Polyethylene Vertical tube: Steel	Oxide lacquer	RAL 8017	—	—
	4005 03	Diffuser: Polyethylene Vertical tube: Steel	White lacquer	RAL 9016	—	—
	4005 14	Diffuser: Polyethylene Vertical tube: Steel	Oxide lacquer	RAL 8017	—	—
	4010 03	Diffuser: Polyethylene Vertical tube: Steel	White lacquer	RAL 9016	—	—
	4010 14	Diffuser: Polyethylene Vertical tube: Steel	Oxide lacquer	RAL 8017	—	—
	4015 03	Diffuser: Polyethylene Vertical tube: Steel	White lacquer	RAL 9016	—	—
	4015 14	Diffuser: Polyethylene Vertical tube: Steel	Oxide lacquer	RAL 8017	—	—
Up	4440 18 /1A	Diffuser: Polycarbonate Body: Aluminum	Matt graphite lacquer	RAL 7016	2700 K. CRI >80. 2481,5 lm. 93,6 lm/W.	Constant Current 700 mA. 110-240V. 50/60Hz.
	4440 18 /4A	Diffuser: Polycarbonate Body: Aluminum	Matt graphite lacquer	RAL 7016	4000 K. CRI >80. 2981,5 lm. 112,5 lm/W.	Constant Current 700 mA. 110-240V. 50/60Hz.
	4440 93 /1A	Diffuser: Polycarbonate Body: Aluminum	Matt white lacquer	RAL 9016	2700 K. CRI >80. 2481,5 lm. 93,6 lm/W.	Constant Current 700 mA. 110-240V. 50/60Hz.
	4440 93 /4A	Diffuser: Polycarbonate Body: Aluminum	Matt white lacquer	RAL 9016	4000 K. CRI >80. 2981,5 lm. 112,5 lm/W.	Constant Current 700 mA. 110-240V. 50/60Hz.

	Item	Materials	Finish	Ral / Pantone	Led	Driver Included	
	4442 18 /1A	Diffuser: Polycarbonate Body: Aluminum	Canopy: Steel	Matt graphite lacquer	RAL 7016	2700 K. CRI >80. 5126,7 lm. 92,7 lm/W.	Constant Current 750 mA. 110-240V. 50/60Hz.
	4442 18 /4A	Diffuser: Polycarbonate Body: Aluminum	Canopy: Steel	Matt graphite lacquer	RAL 7016	4000 K. CRI >80. 6159,5 lm. 111,4 lm/W.	Constant Current 750 mA. 110-240V. 50/60Hz.
	4442 93 /1A	Diffuser: Polycarbonate Body: Aluminum	Canopy: Steel	Matt white lacquer	RAL 9016	2700 K. CRI >80. 5126,7 lm. 92,7 lm/W.	Constant Current 750 mA. 110-240V. 50/60Hz.
	4442 93 /4A	Diffuser: Polycarbonate Body: Aluminum	Canopy: Steel	Matt white lacquer	RAL 9016	4000 K. CRI >80. 6159,5 lm. 111,4 lm/W.	Constant Current 750 mA. 110-240V. 50/60Hz.
	4452 18 /1A	Diffuser: Polycarbonate Body: Aluminum	Canopy: Steel	Matt graphite lacquer	RAL 7016	2700 K. CRI >80. 3956,7 lm. 79,1 lm/W.	Constant Current 900 mA. 110-240V. 50/60Hz.
	4452 18 /4A	Diffuser: Polycarbonate Body: Aluminum	Canopy: Steel	Matt graphite lacquer	RAL 7016	4000 K. CRI >80. 4753,8 lm. 95,1 lm/W.	Constant Current 900 mA. 110-240V. 50/60Hz.
	4452 93 /1A	Diffuser: Polycarbonate Body: Aluminum	Canopy: Steel	Matt white lacquer	RAL 9016	2700 K. CRI >80. 3956,7 lm. 79,1 lm/W.	Constant Current 900 mA. 110-240V. 50/60Hz.
	4452 93 /4A	Diffuser: Polycarbonate Body: Aluminum	Canopy: Steel	Matt white lacquer	RAL 9016	4000 K. CRI >80. 4753,8 lm. 95,1 lm/W.	Constant Current 900 mA. 110-240V. 50/60Hz.
	4454 18 /1A	Diffuser: Polycarbonate Body: Aluminum	Canopy: Steel	Matt graphite lacquer	RAL 7016	2700 K. CRI >80. 3956,7 lm. 79,1 lm/W.	Constant Current 900 mA. 110-240V. 50/60Hz.
	4454 18 /4A	Diffuser: Polycarbonate Body: Aluminum	Canopy: Steel	Matt graphite lacquer	RAL 7016	4000 K. CRI >80. 4753,8 lm. 95,1 lm/W.	Constant Current 900 mA. 110-240V. 50/60Hz.
	4454 93 /1A	Diffuser: Polycarbonate Body: Aluminum	Canopy: Steel	Matt white lacquer	RAL 9016	2700 K. CRI >80. 3956,7 lm. 79,1 lm/W.	Constant Current 900 mA. 110-240V. 50/60Hz.
	4454 93 /4A	Diffuser: Polycarbonate Body: Aluminum	Canopy: Steel	Matt white lacquer	RAL 9016	4000 K. CRI >80. 4753,8 lm. 95,1 lm/W.	Constant Current 900 mA. 110-240V. 50/60Hz.
	4460 18 /1A	Diffuser: Polycarbonate Body: Aluminum	Canopy: Steel	Matt graphite lacquer	RAL 7016	2700 K. CRI >80. 7608,2 lm. 93 lm/W.	Constant Current 700/750 mA. 110-240V. 50/60Hz.
	4460 18 /4A	Diffuser: Polycarbonate Body: Aluminum	Canopy: Steel	Matt graphite lacquer	RAL 7016	4000 K. CRI >80. 9140,9 lm. 111,8 lm/W.	Constant Current 700/750 mA. 110-240V. 50/60Hz.
	4460 93 /1A	Diffuser: Polycarbonate Body: Aluminum	Canopy: Steel	Matt white lacquer	RAL 9016	2700 K. CRI >80. 7608,2 lm. 93 lm/W.	Constant Current 700/750 mA. 110-240V. 50/60Hz.
	4460 93 /4A	Diffuser: Polycarbonate Body: Aluminum	Canopy: Steel	Matt white lacquer	RAL 9016	4000 K. CRI >80. 9140,9 lm. 111,8 lm/W.	Constant Current 700/750 mA. 110-240V. 50/60Hz.
Vol	0220 03	Shade: Glass	Disc: Aluminum	Matt white lacquer	RAL 9016	—	—
	0225 03	Shade: Glass	Disc: Aluminum	Matt white lacquer	RAL 9016	—	—
Warm	4895 58	Shade: Screen Diffuser: Methacrylate	Rod: Aluminum Base: Steel	Off-white matt lacquer	RAL D2 1109005	—	—
	4896 06	Shade: Screen Diffuser: Methacrylate	Rod: Aluminum Base: Steel	Matt red lacquer	PANTONE 704M	—	—
	4896 14	Shade: Screen Diffuser: Methacrylate	Rod: Aluminum Base: Steel	Matt dark-brown lacquer	RAL 8019	—	—
	4896 58	Shade: Screen Diffuser: Methacrylate	Rod: Aluminum Base: Steel	Off-white matt lacquer	RAL D2 1109005	—	—
	4900 58	Shade: Screen Diffuser: Methacrylate	Rod: Aluminum Base: Steel	Off-white matt lacquer	RAL D2 1109005	—	—
	4901 06	Shade: Screen Diffuser: Methacrylate	Rod: Aluminum Base: Steel	Matt red lacquer	PANTONE 704M	—	—
	4901 14	Shade: Screen Diffuser: Methacrylate	Rod: Aluminum Base: Steel	Matt dark-brown lacquer	RAL 8019	—	—
	4901 58	Shade: Screen Diffuser: Methacrylate	Rod: Aluminum Base: Steel	Off-white matt lacquer	RAL D2 1109005	—	—

Product specifications subject to change without notice.
Please check vibia.com for updated information.

	Item	Materials	Finish	Ral / Pantone	Led	Driver Included
	4905 58	Shade: Screen Diffuser: Methacrylate	Rod: Aluminum Base: Steel	Off-white matt lacquer	RAL D2 1109005	—
	4906 06	Shade: Screen Diffuser: Methacrylate	Rod: Aluminum Base: Steel	Matt red lacquer	PANTONE 704M	—
	4906 14	Shade: Screen Diffuser: Methacrylate	Rod: Aluminum Base: Steel	Matt dark-brown lacquer	RAL 8019	—
	4906 58	Shade: Screen Diffuser: Methacrylate	Rod: Aluminum Base: Steel	Off-white matt lacquer	RAL D2 1109005	—
	4925 58	Shade: Screen	Diffuser: Methacrylate	Off-white matt lacquer	RAL D2 1109005	—
	4926 06	Shade: Screen	Diffuser: Methacrylate	Matt red lacquer	PANTONE 704M	—
	4926 14	Shade: Screen	Diffuser: Methacrylate	Matt dark-brown lacquer	RAL 8019	—
	4926 58	Shade: Screen	Diffuser: Methacrylate	Off-white matt lacquer	RAL D2 1109005	—
	4930 58	Shade: Screen	Diffuser: Methacrylate	Off-white matt lacquer	RAL D2 1109005	—
	4935 58	Shade: Screen	Diffuser: Methacrylate	Off-white matt lacquer	RAL D2 1109005	—
Wind	4055 03	Shade: Filament Winding Weight: Concrete	Lid: Steel Diffuser: Methacrylate	White fiberglass	RAL 9016	—
	4055 04	Shade: Filament Winding Weight: Concrete	Lid: Steel Diffuser: Methacrylate	Black fiberglass	RAL 9005	—
	4055 07	Shade: Filament Winding Weight: Concrete	Lid: Steel Diffuser: Methacrylate	Green fiberglass	RAL 6018	—
	4055 08	Shade: Filament Winding Weight: Concrete	Lid: Steel Diffuser: Methacrylate	Orange fiberglass	RAL 2008	—
	4060 03	Shade: Filament Winding Base: Filament Winding	Diffuser: Methacrylate	Matt white lacquer	RAL 9016	3100 K. CRI >80. 5008,4 lm. 80,6 lm/W.
	4060 07	Shade: Filament Winding Base: Filament Winding	Diffuser: Methacrylate	Matt green lacquer	RAL 6018	3100 K. CRI >80. 5008,4 lm. 80,6 lm/W.
	4060 08	Shade: Filament Winding Base: Filament Winding	Diffuser: Methacrylate	Orange fiberglass	RAL 2008	3100 K. CRI >80. 5008,4 lm. 80,6 lm/W.
	4065 03	Shade: Filament Winding Base: Filament Winding	Diffuser: Methacrylate	White fiberglass	RAL 9016	3100 K. CRI >80. 1800 lm. 74,7 lm/W.
	4065 07	Shade: Filament Winding Base: Filament Winding	Diffuser: Methacrylate	Green fiberglass	RAL 6018	3100 K. CRI >80. 1800 lm. 74,7 lm/W.
	4065 08	Shade: Filament Winding Base: Filament Winding	Diffuser: Methacrylate	Orange fiberglass	RAL 2008	3100 K. CRI >80. 1800 lm. 74,7 lm/W.
	4070 03	Shade: Filament Winding Canopy Plate: Steel	Lid: Steel Diffuser: Methacrylate	White fiberglass	RAL 9016	—
	4070 04	Shade: Filament Winding Canopy Plate: Steel	Lid: Steel Diffuser: Methacrylate	Black fiberglass	RAL 9005	—
	4070 07	Shade: Filament Winding Canopy Plate: Steel	Lid: Steel Diffuser: Methacrylate	Green fiberglass	RAL 6018	—
	4070 08	Shade: Filament Winding Canopy Plate: Steel	Lid: Steel Diffuser: Methacrylate	Orange fiberglass	RAL 2008	—
	4075 03	Shade: Filament Winding Canopy Plate: Steel	Lid: Steel Diffuser: Methacrylate	White fiberglass	RAL 9016	—
	4075 04	Shade: Filament Winding Canopy Plate: Steel	Lid: Steel Diffuser: Methacrylate	Black fiberglass	RAL 9005	—
	4075 07	Shade: Filament Winding Canopy Plate: Steel	Lid: Steel Diffuser: Methacrylate	Green fiberglass	RAL 6018	—

	Item	Materials	Finish	Ral / Pantone	Led	Driver Included
	4075 08	Shade: Filament Winding Canopy Plate: Steel	Lid: Steel Diffuser: Methacrylate	Orange fiberglass	RAL 2008	—
	4076 03	Shade: Filament Winding Canopy Plate: Steel	Lid: Steel Diffuser: Methacrylate	White fiberglass	RAL 9016	—
	4076 07	Shade: Filament Winding Canopy Plate: Steel	Lid: Steel Diffuser: Methacrylate	Green fiberglass	RAL 6018	—
	4076 08	Shade: Filament Winding Canopy Plate: Steel	Lid: Steel Diffuser: Methacrylate	Orange fiberglass	RAL 2008	—
Wireflow	0299 04 /1A	Diffuser: Glass Rods: Steel	Body: Aluminum Canopy: Steel	Black lacquer	RAL 9005	2700 K. CRI >80. 3615,5 lm. 100,4 lm/W.
	0300 04 /1A	Diffuser: Glass Rods: Steel	Body: Aluminum Canopy: Steel	Black lacquer	RAL 9005	2700 K. CRI >80. 3615,5 lm. 100,4 lm/W.
	0301 04 /1A	Diffuser: Glass Rods: Steel	Body: Aluminum Canopy: Steel	Black lacquer	RAL 9005	2700 K. CRI >80. 3615,5 lm. 100,4 lm/W.
	0302 04 /1A	Diffuser: Glass Rods: Steel	Body: Aluminum Canopy: Steel	Black lacquer	RAL 9005	2700 K. CRI >80. 3615,5 lm. 100,4 lm/W.
	0303 04 /1A	Diffuser: Glass Rods: Steel	Body: Aluminum Canopy: Steel	Black lacquer	RAL 9005	2700 K. CRI >80. 3615,5 lm. 100,4 lm/W.
	0304 04 /1A	Diffuser: Glass Rods: Steel	Body: Aluminum Canopy: Steel	Black lacquer	RAL 9005	2700 K. CRI >80. 2711,6 lm. 100,4 lm/W.
	0305 04 /1A	Diffuser: Glass Rods: Steel	Body: Aluminum Canopy: Steel	Black lacquer	RAL 9005	2700 K. CRI >80. 2711,6 lm. 100,4 lm/W.
	0306 04 /1A	Diffuser: Glass Rods: Steel	Body: Aluminum Canopy: Steel	Black lacquer	RAL 9005	2700 K. CRI >80. 2711,6 lm. 100,4 lm/W.
	0307 04 /1A	Diffuser: Glass Rods: Steel	Body: Aluminum Canopy: Steel	Black lacquer	RAL 9005	2700 K. CRI >80. 2711,6 lm. 100,4 lm/W.
	0308 04 /1A	Diffuser: Glass Rods: Steel	Body: Aluminum Canopy: Steel	Black lacquer	RAL 9005	2700 K. CRI >80. 2711,6 lm. 100,4 lm/W.
	0309 04 /1A	Diffuser: Glass Rods: Steel	Body: Aluminum Canopy: Steel	Black lacquer	RAL 9005	2700 K. CRI >80. 1807,7 lm. 100,4 lm/W.
	0310 04 /1A	Diffuser: Glass Rods: Steel	Body: Aluminum Canopy: Steel	Black lacquer	RAL 9005	2700 K. CRI >80. 1807,7 lm. 100,4 lm/W.
	0311 04 /1A	Diffuser: Glass Rods: Steel	Body: Aluminum Canopy: Steel	Black lacquer	RAL 9005	2700 K. CRI >80. 1807,7 lm. 100,4 lm/W.
	0312 04 /1A	Diffuser: Glass Rods: Steel	Body: Aluminum Canopy: Steel	Black lacquer	RAL 9005	2700 K. CRI >80. 1807,7 lm. 100,4 lm/W.
	0313 04 /1A	Diffuser: Glass Rods: Steel	Body: Aluminum Canopy: Steel	Black lacquer	RAL 9005	2700 K. CRI >80. 1807,7 lm. 100,4 lm/W.
	0315 04 /1A	Diffuser: Glass Rods: Steel	Body: Aluminum Canopy: Steel	Black lacquer	RAL 9005	2700 K. CRI >80. 9038,9 lm. 100,4 lm/W.
	0320 04 /1B	Diffuser: Polycarbonate Body: Aluminum	Rods: Steel Canopy: Aluminum	Black lacquer	RAL 9005	2700 K. CRI >80. 903,8 lm. 100,4 lm/W.
	0325 04 /1B	Diffuser: Polycarbonate Body: Aluminum	Rods: Steel Canopy: Aluminum	Black lacquer	RAL 9005	2700 K. CRI >80. 2711,6 lm. 100,4 lm/W.
	0330 04 /1B	Diffuser: Polycarbonate Body: Aluminum	Rods: Steel Canopy: Aluminum	Black lacquer	RAL 9005	2700 K. CRI >80. 4519,4 lm. 100,4 lm/W.
	0332 04 /1B	Diffuser: Polycarbonate Body: Aluminum	Rods: Steel Canopy: Aluminum	Black lacquer	RAL 9005	2700 K. CRI >80. 4519,4 lm. 100,4 lm/W.
	0338 04 /1B	Diffuser: Polycarbonate Body: Aluminum	Rods: Steel Canopy: Aluminum	Black lacquer	RAL 9005	2700 K. CRI >80. 2711,6 lm. 100,4 lm/W.
	0340 04 /1B	Diffuser: Polycarbonate Body: Aluminum	Rods: Steel Canopy: Aluminum	Black lacquer	RAL 9005	2700 K. CRI >80. 3615,5 lm. 100,4 lm/W.

Item index / Índice referencias

Model	Pag.	Model	Pag.	Model	Pag.	Model	Pag.	Model	Pag.	Model	Pag.	Model	Pag.	Model	Pag.	Model	Pag.
0220	92	0402	35	0860	18	2014	260	4035	398	4790	358	5464	306	7210	123		
0225	92	0403	35	0865	18	2015	300 / 395	4040	398	4795	358	5466	306	7211	123		
0250	145	0404	35	0870	18	2110	69	4055	380	4800	368	5468	306	7220	123		
0260	143	0405	35	0875	18	2111	69	4060	380	4801	368	5500	174	7221	123		
0270	64	0406	35	0880	18	2112	69	4065	380	4802	368	5505	174	7230	123		
0271	64	0407	35	0885	18	2113	69	4070	116 / 380	4803	368	5510	166	7231	123		
0275	64	0408	35	0914	112	2120	69	4075	116 / 380	4804	368	5515	166	7250	124		
0276	64	0409	35	0915	112	2121	69	4076	116	4805	368	5520	76	7251	124		
0280	64	0410	35	0916	112	2122	69	4101	387	4810	368	5525	76	7260	124		
0282	64	0411	35	0917	112	2130	69	4106	387	4811	368	5530	76	7261	124		
0299	35	0412	35	0920	112	2131	69	4108	387	4812	368	5535	76	7270	125		
0300	35	0413	35	0925	112	2132	69	4110	388	4815	368	5600	140	7271	125		
0301	35	0503	154	0931	112	2133	69	4125	416	4820	370	5605	140	7280	124		
0302	35	0507	190	0933	112	2140	73	4130	416	4895	204	5620	140	7281	124		
0303	35	0509	341	0935	112	2141	73	4135	416	4896	204	5625	140	7290	125		
0304	35	0514	341	0937	112	2142	73	4136	416	4900	204	5630	274	7291	125		
0305	35	0516	155	0940	112	2143	73	4150	391	4901	204	5635	274	7749	280		
0306	35	0521	191	0960	264 / 332	2150	73	4200	322	4905	150	5640	274	7750	280		
0307	35	0526	340	0962	264 / 332 / 400	2151	73	4201	322	4906	150	5642	274	7751	280		
0308	35	0530	232	1128	268	2152	73	4202	322	4925	96	5644	274	7752	280		
0309	35	0531	232	1129	268	2160	73	4204	322	4926	96	5660	88	7753	280		
0310	35	0532	232	1132	268	2161	73	4205	322	4930	96	5662	88	7759	280		
0311	35	0533	232	1133	268	2162	73	4207	322	4935	96	5664	88	7760	280		
0312	35	0535	105	1134	268	2163	73	4210	325	5066	194	5670	88	7761	280		
0313	35	0536	105	1138	268	2170	73	4211	325	5068	194	5672	88	7762	280		
0315	48	0537	105	1139	268	2175	73	4440	217	5189	162	5674	88	7763	280		
0320	38	0538	105	1330	158	2180	73	4442	217	5190	162	5700	220 / 319	7764	280		
0325	38	0540	236	1332	192	2200	100	4452	217	5191	162	5710	220 / 319	7920	314		
0330	38	0543	236	1333	192	2201	100	4454	217	5192	162	6005	134	7925	314		
0332	38	0544	236	1336	106	2205	100	4460	217	5351	228	6006	134	7930	314		
0338	38	0546	236	1338	106	2206	100	4500	290 / 412	5356	228	6007	134	7935	314		
0340	38	0547	236	1510	28	2210	100	4501	290 / 412	5361	228	6010	134	7940	314		
0345	44	0605	248	1515	28	2211	100	4504	290 / 412	5366	228	6011	134	7950	314		
0347	44	0615	248	1520	28	2215	100	4506	290 / 412	5373	224	6012	134	7955	314		
0348	44	0620	248	1525	28	2216	100	4508	290 / 412	5376	224	6025	182	8090	344		
0349	44	0621	248	1530	28	2220	100	4510	409	5379	224	6026	182	8091	344		
0350	44	0625	248	1535	28	2221	100	4515	409	5380	224	6027	182	8092	344		
0351	44	0626	248	1540	28	2225	100	4520	409	5381	224	6030	182	8093	344		
0353	44	0630	252 / 393	1550	28	2226	100	4525	409	5384	224	6031	182	8094	344		
0355	44	0631	252 / 393	1560	28	2230	102	4530	409	5385	224	6032	182	8095	344		
0356	44	0635	252 / 393	1650	178	2330	84	4535	409	5388	224	6035	296	8200	256		
0358	44	0636	252 / 393	1655	178	2331	84	4536	409	5389	224	6040	296	8201	256		
0360	44	0640	252	1660	130	2332	84	4600	374	5395	224	6041	296	8205	256		
0361	44	0641	252	1665	130	2333	84	4625	362	5396	224	6045	296	8206	256		
0362	44	0700	200	1670	130	2340	80	4630	362	5400	240 / 328	6046	296	8210	256		
0363	44	0712	147	1675	286	2341	80	4635	362	5402	240 / 328	6050	296	8211	256		
0364	44	0720	302	1680	286	2342	80	4640	362	5410	240 / 328	7140	122	8250	244		
0365	44	0725	302	1685	286	2343	80	4710	420	5412	240 / 328	7141	122	8251	244		
0366	44	0750	186	1686	286	2500	52	4715	420	5425	328	7150	122	8252	244		
0367	44	0751	186	1690	286	2501	52	4717	420	5427	328	7151	122	8960	267		
0368	44	0755	186	1692	286	2502	52	4720	420	5430	240	7160	122	8962	267		
0369	44	0756	186	1694	286	2510	52	4730	358	5432	240	7161	122	8970	267		
0374	48	0820	18	1700	348	2511	52	4735	358	5435	240	7170	122	8972	267		
0375	48	0825	18	1705	348	2515	52	4745	358	5437	240	7171	122	8980	267		
0376	48	0830	18	1715	348	2516	52	4750	358	5440	240	7180	122	8982	267		
0377	48	0835	18	2004	260 / 336	4000	404	4765	358	5442	240	7181	122	Match	58		
0378	48	0840	18	2005	260 / 336	4005	404	4770	358	5445	240	7190	122				
0399	35	0845	18	2007	260	4010	404	4775	358	5447	240	7191	122				
0400	35	0850	18	2012	260 / 336	4015	404	4780	358	5460	306	7200	122				
0401	35	0855	18	2013	260 / 336	4030	398	4785	358	5461	306	7201	122				

Glossary / Glosario

CE

Product complying with the EN60598-1 and EN60598-2-1 European regulation. /
Producto que cumple la normativa europea EN60598-1 y EN60598-2-1.

IP

Level of protection. Electrical products are prepared to avoid solids and liquids from getting in contact with the electrical parts. Such resistance is expressed as IP followed by two digits: the first digit indicates the level of resistance to solid objects and the second one to liquids. The scale goes from IP20 to IP68. /

Nivel de protección del producto. Los aparatos eléctricos están preparados para impedir la entrada y el contacto de cuerpos sólidos y de líquidos con las partes eléctricas. Esta resistencia se expresa mediante las siglas IP seguidas de 2 dígitos: el primero expresa el grado de protección a los objetos sólidos, y el segundo a los líquidos. Escala comprendida entre los valores IP20 y IP68.

IP20

Product protected against solid object as big as or bigger than 12 mm. No protection against water. /

Producto protegido contra la penetración de cuerpos sólidos de tamaño igual o superior a 12mm. Sin protección al agua.

IP64

Dust-tight product. Protected against water spray. /

Producto estanco al polvo. Protección contra las salpicaduras de agua.

IP65

Dust-tight product. Protected against water trickles. /

Producto estanco al polvo. Protección contra los chorros de agua.

IP66

Dust-tight product. Protected against water spurts. /

Producto estanco al polvo. Protección contra los chorros fuertes de agua.

INSULATION CLASS / CLASE AISLAMIENTO



Class I. Product with an additional protection cable (grounds). /

Clase I. Aparato con un cable protector adicional (toma de tierra).



Class II. Product protected against electric shock having a double insulation. No grounds. /

Clase II. Aparato con protección contra descargas eléctricas, basado en un doble aislamiento. Sin toma de tierra.



Class III. Product protected against electric shock based on a very-low voltage system. No grounds. /

Clase III. Aparato con protección contra descargas eléctricas, basado en un sistema de muy bajo voltaje. Sin toma de tierra.

FLAMMABLE SURFACES / SUPERFICIES INFLAMABLES



Product suitable to be installed on any kind of surface (EN 60598). /

Producto apto para ser montado en todo tipo de superficies (EN 60598).



Product that CANNOT be in contact with normally-flammable materials (wood or others). /

No está permitido que producto con este distintivo esté en contacto con materiales normalmente inflamables (maderas u otros).

Bi-volt

Valid for the range 110V-230V, 50-60Hz.

Válido para el rango 110V-230V, 50-60Hz.

CUT OUT / DIMENSIÓN DE CORTE



Dimension of the cut-out. /

Dimensión del alojamiento para empotrar.

NO ELECTRONIC EQUIPMENT INCLUDED / EQUIPO NO INTEGRADO



The lamp does not include any electronic equipment

(transformer, driver, ballast...)/

La luminaria no incluye el equipo electrónico correspondiente

(transformador, driver, reactancia...).

INTEGRATED DIMMER / REGULADOR INTENSIDAD INTEGRADO

Dimmer

Lamp that has a integrated dimmer. /

Luminaria que lleva incorporado el equipo de regulación de intensidad.

LIGHT SOURCE INFORMATION / INFORMACIÓN FUENTE DE LUZ

CRI

Color rendering index. /

Índice de reproducción cromática.

K

Color temperature. /

Temperatura de color.

lm

Lumen, unit of measurement of luminous flux. /

Lumen, unidad de medida del flujo luminoso.

lm/W

Light source performance. Relationship between the luminous flux (lm) and the power consumed (W) by the source. /

Rendimiento luminoso de la fuente de luz. Relación entre el flujo luminoso (lm) y la potencia consumida (W) por dicha fuente.

Item recoding / Nueva codificación artículos

ITEM / ARTÍCULO

Reference / Referencia			
1510 18 /1 B.			
Model / Modelo	Finish / Acabado	LED color temperature / Temperatura de color LED	Dimming typology / Tipo de Regulación
4 digits / 4 dígitos	2 digits / 2 dígitos	1 digit / 1 dígito	1 digit / 1 dígito
		0 > Without LED / Sin LED 1 > 2700 K 2 > 3000 K 3 > 3500 K 4 > 4000 K	0 > Dimmable: No / Sin regulación 1 > DALI 2 > 0-10V 3 > 1-10V 4 > TRIAC 5 > Push / Pulsador 6 > Sensor A > 1+3+5 (DALI + 1-10V + Push / Pulsador) B > 3+5 (1-10V + Push / Pulsador) C > 1+3 (DALI + 1-10V) Z > Smart *

* Smart refers to wireless dimming solutions.

Ask for more information /

Smart se refiere a soluciones de regulación inalámbricas. Pedir más información.

Acknowledgements / Agradecimientos

Ton
Photographer: Martin Chum
(page 32)

www.lundbergdesign.com
Photographer: Patricia Chang Photography
(page 42)

Giorgio Possenti
www.giorgiopossenti.com
Elle Decor
(page 58)

La Caixa
Photographer: Eugeni Pons
(page 60)

Arper
www.arper.com
Photographer: Marco Covi
(page 61)

Casa Giolitti
Photographer: Manuela Cerri
Designer: Studio Fabio Fantolino
(page 62)

WSA Showroom
(page 67)

Photographer: Pulch Photography
(page 69-71)

Iluminación Ambiente
Arquitecto: Jorge Belloch
(page 71)

Designer: SevilPeach Architecture + Design
Client: Spaces
Photographer: Ewout Huibers
(page 78-83-92-110)

Photographer: ©Gilbert McCarragher 2014
(www.gilbertmccarragher.com)
(page 104)

Minotti
www.minotti.com
(page 162)

Penthouse / Apartment in Tel Aviv
Lighting Design: Orly Avron Alkabes
Architecture: Pitsou Kedem Architects
Photography: Amit Geron
(page 223-323)

Design by Shoup Interieur Designer
(page 307)

The contents of this catalogue may be changed or cancelled
at the discretion of the VIBIA management without prior notice. /
VIBIA se reserva el derecho de efectuar cualquier modificación y anulación
de los productos del catálogo vigente sin previo aviso alguno.

Download the catalogue app. Descárgate la app del catálogo.



vibia.com

VIBIA LIGHTING, S.L.U. Barcelona, 72 - 74. 08820 El Prat de Llobregat (Barcelona - Spain). vibia@vibia.com
International Tel +34 934 796 971. Fax +34 934 782 026. **Spain & Portugal** Tel 934 796 970. Fax 934 796 973.

VIBIA, INC. USA. 272 Fernwood Ave. Edison, NJ 08837. Phone 732 417 1700. Fax 732 417 1701.

COPYRIGHT© VIBIA LIGHTING, S.L.U. ALL RIGHTS RESERVED.

